

SERIES 7400

INTELLIGENT LDT INTERFACE MODULE

USER'S MANUAL

Catalog Number 7400-394M

This Manual is written to explain the operation of the following AMCI Modules for the Square D SY/MAX[®] I/O System:

7451
7452
7451-01

General Information

Important User Information

The products and application data described in this manual are useful in a wide variety of different applications. Therefore, the user and others responsible for applying these products described herein are responsible for determining the acceptability for each application. While efforts have been made to provide accurate information within this manual, AMCI assumes no responsibility for the application or the completeness of the information contained herein.

UNDER NO CIRCUMSTANCES WILL ADVANCED MICRO CONTROLS, INC. BE RESPONSIBLE OR LIABLE FOR ANY DAMAGES OR LOSSES, INCLUDING INDIRECT OR CONSEQUENTIAL DAMAGES OR LOSSES, ARISING FROM THE USE OF ANY INFORMATION CONTAINED WITHIN THIS MANUAL, OR THE USE OF ANY PRODUCTS OR SERVICES REFERENCED HEREIN.

Throughout this manual the following two notices are used to highlight important points.



WARNINGS tell you when people may be hurt or equipment may be damaged if the procedure is not followed properly.



CAUTIONS tell you when equipment may be damaged if the procedure is not followed properly.

No patent liability is assumed by AMCI, with respect to use of information, circuits, equipment, or software described in this manual.

The information contained within this manual is subject to change without notice.

Standard Warranty

ADVANCED MICRO CONTROLS, INC. warrants that all equipment manufactured by it will be free from defects, under normal use, in materials and workmanship for a period of [1] year. Within this warranty period, AMCI shall, at its option, repair or replace, free of charge, any equipment covered by this warranty which is returned, shipping charges prepaid, within one year from date of invoice, and which upon examination proves to be defective in material or workmanship and not caused by accident, misuse, neglect, alteration, improper installation or improper testing.

The provisions of the "STANDARD WARRANTY" are the sole obligations of AMCI and excludes all other warranties expressed or implied. In no event shall AMCI be liable for incidental or consequential damages or for delay in performance of this warranty.

Returns Policy

All equipment being returned to AMCI for repair or replacement, regardless of warranty status, must have a Return Merchandise Authorization number issued by AMCI. Call (203) 585-1254 with the model number and serial number (if applicable) along with a description of the problem. A "RMA" number will be issued. Equipment must be shipped to AMCI with transportation charges prepaid. Title and risk of loss or damage remains with the customer until shipment is received by AMCI.

24 Hour Technical Support Number

24 Hour technical support is available on this product.

For technical support, call (203) 583-7271.

TABLE OF CONTENTS

Important User Information	Inside Cover
Standard Warranty	Inside Cover
Returns Policy	Inside Cover
24 Hour Tech. Support Line	Inside Cover
About This Manual	1-1
CHAPTER 1: INTRODUCTION TO THE SERIES 7400 TEMPOSONICS INTERFACE MODULE	
7400 Family Members	1-1
Functions and Parameters	1-2
Set-up Parameters	1-2
Application Notes	1-4
CHAPTER 2: SERIES 7400 MODULE DESCRIPTION	
Front Panel Description	2-1
Function and Parameter Displays	2-2
Position Data Function	2-2
Velocity Data Function	2-2
Count Direction Parameter	2-2
Full Scale Length Parameter	2-3
Full Scale Count Parameter	2-3
Position Offset Parameter	2-3
Setup Parameter Display	2-4
Connection Type Parameter	2-4
DPM Recirculations Parameter	2-4
Measurement Unit Parameter	2-5
LDT Gradient Parameter	2-5
Decimal Point Parameter	2-5
Preset Value Parameter	2-6
Speed Average Parameter	2-6
Status Indicators	2-7
Program Switch	2-9
Keyboard Description	2-10
Transducer Input Connector	2-11
Fuse Replacement	2-11
Specifications	2-12
CHAPTER 3: INSTALLATION	
Power Requirements	3-1
Installing the Module	3-1
Addressing the 7400 Modules	3-2
Compatible Transducers	3-3
DPM Setup	3-3
Transducer Mounting	3-3
Transducer Cable Numbers	3-3
Temposonics II Cabling	3-4
7451 Single Axis Transducer Cable	3-4
7452 Two Axis Transducer Cable	3-5

TABLE OF CONTENTS (cont'd)

CHAPTER 4: SERIES 7400 KEYBOARD PROGRAMMING

Conventions	4-1
Count Direction	4-2
Full Scale Length	4-2
Full Scale Count	4-3
Position Offset	4-3
Connection Type	4-4
DPM Recirculations	4-4
Measurement Unit	4-5
LDT Gradient	4-5
Decimal Point Position	4-5
Preset Value	4-6
Auto Preset Feature	4-6
Speed Average	4-6

CHAPTER 5: SERIES 7400 DATA FORMAT

Data Format	5-1
-------------------	-----

APPENDIX A: ADDITIONAL INSTRUCTIONS: 7451-01

Front Panel Description	A-1
Fiber Optic Cable Installation	A-2
RS-485 Cable Installation	A-2
Additional Displays and Keyboard Programming	A-3
Number of Splices	A-3
Fiber Optic Run Length	A-3
Additional Error Messages	A-4
Transducer Cable Changes	A-4

PRINTS

B1153 Rev A. Series 1400 Outline Drawing	P-1
B1189 7451-01 Outline and Connector Pin-out	P-2
B1194 Temposonics 1 Channel Wiring Diagram w/ MS-8W	P-3
B1178 Rev A. Temposonics 1 Channel Wiring Diagram	P-4
B1177 Temposonics 2 Channel Wiring Diagram	P-5

Revision History

This revision (7400-394M) superceeds 7400-593M. It corrects data format description errors on page 5-1 and includes changes made to the 7451-01. It was first released March 11, 1994.

ABOUT THIS MANUAL

The objective of this manual is to explain the installation, operation, programming, and servicing of the Series 7400 Temposonics Interface Modules for the Square D Sy/Max Series I/O Rack. It is strongly recommended that you read through the following instructions. If there are any unanswered questions after reading this manual, call the factory. An applications engineer will be available to assist you.

CHP 1: INTRODUCTION TO THE SERIES 7400 TEMPOSONICS INTERFACE MODULES

Utilizing the latest in programmable chip technology, the Series 7400 Modules are a direct interface between the MTS Temposonics Linear Displacement Transducers (LDT's) and your Square D programmable controller. Each module occupies only one Register slot in the rack. A Series 7400 module can interface with up to 2 different LDT's and report position, velocity, and fault diagnostics data for both to the processor.

The 7400 Modules contain an internal power supply for the Temposonics transducers and draws all of it's system power from the backplane. This eliminates the need for a separate supply and simplifies system installation and trouble-shooting. As an added safety feature, the 7400 Modules monitor the output current from the internal supply and turn it off if a short circuit condition exists.

On the front panel, a six digit alpha-numeric display and sealed keyboard allows the monitoring of the transducers position and velocity. The following parameters are also programmable from the keyboard: Count Direction, Full Scale Length, Full Scale Count, Position Offset, and 7 other parameters such as LDT Gradient and Position Preset Value. Modules communicate with the PLC via Registers assigned to the Module. Position and Velocity data for all of the module's axes is available to the processor on every scan.

7400 Family Members

The following table lists the model numbers of the two Temposonics Interface Modules presently available in the Series 7400 Family.

7451	1 axis, 100000 count Module
7452	2 axes, 100000 count Module

Fig. 1.1 7400 Modules

Functions and Parameters

The 7400's perform two operations. These two operation are called FUNCTIONS. These Functions are:

- Position Data Function - Gives you information on the position of the LDT's magnet relative to a zero point.
- Velocity Data Function - Gives you information on the velocity of the magnet along the LDT's shaft.

Each Function is defined by one or more inputs. One input is the Temposonics LDT transducer. The other inputs are programmable from the keyboard. These inputs are called PARAMETERS.

- Count Direction - Sets the direction, relative to the head of the LDT, that the magnet must travel to increment the Position Data.
- Full Scale Length - Programmable in inches or millimeters, this parameter is the length that you expect the magnet to travel. Maximum value is 2600 inches or 9999 millimeters.
- Full Scale Count - This parameter sets the number of counts over the Full Scale Length. The position resolution is equal to the Full Scale Length ÷ Full Scale Count. Maximum resolution is 0.001 inches or 0.1 millimeters.
- Position Offset - This parameter is used to change the value of the Position Function without moving the magnet on the LDT. Most commonly used to set the zero or starting position of the magnet along the LDT's length.

SET-UP PARAMETERS

These parameters are only available when the module is in Program Mode (See *Program Switch* Pg. 2-9 for more information.) These parameters contain information that would not be changed often once the system is running.

- Connection Type - This parameter is used to tell the module the type of Personality Module installed in the head of the Temposonics LDT. Presently, RPM and DPM Modules are supported. When using the 7452 Plug-in card, the Personality Modules in the two LDTs can be different.
- DPM Recirculations - This parameter is shown only when a DPM module is selected as the Connection Type. This parameter tells the module how many Recirculations the DPM Module is set for. Allowable values are 1, 2, and 4 recirculations.
- Measurement Unit - Specifies the measurement unit as inches or millimeters. Affects the Full Scale Length and LDT Gradient parameters.

Functions and Parameters (cont'd)

SET-UP PARAMETERS (cont'd)

- LDT Gradient - This is the calibration parameter supplied by MTS on their transducers. It is the rate at which the return pulse propagates down the transducer's length.
- Decimal Point Position - Used to fix a decimal point on the Position, Full Scale Count, and Position Offset displays, this parameter is for the convenience of someone looking at the display. It does not affect the data sent to the processor.
- Preset Value - This parameter specifies the value that the Position Function will change to when the Auto Preset feature is used. The Auto Preset feature is most commonly used to set the Position Function to the correct value when the LDT is at it's home or zero position.
- Speed Average - Sets the update time of the 7400's Velocity Function. Update time is the amount of time that the Module totals the change in position of the magnet before calculating the velocity of the magnet in Counts per Second.

Application Notes:

The Measurement Unit Parameter is in some ways the fundamental Parameter of the 7400. This parameter effects the values that can be entered for the Full Scale Length, Full Scale Count and LDT Gradient Parameters. Changing the Measurement Unit Parameter resets most other Parameters to their default values.

The Full Scale Length and Full Scale Count parameters give you the ability to scale the outputs of the Position and Velocity Functions to a range of meaningful values for your application.

Perhaps your application is straightforward. You are using the full length of the Temposonics probe and measuring the distance to a resolution of 0.001 inches. In this case you would program the Full Scale Length to the length of the transducer and then program the Full Scale Counts to 1000 times the Full Scale Length.

Perhaps your application requires you to measure some value other than length. One application that may arise in process control applications is measuring the amount of liquid in a cylindrical tank. One solution to this measurement problem is to use the 7400 to measure the height of the liquid and use the Programmable Controller program to calculate the amount of liquid in the tank. The other solution, one that is possible because of the 7400's programmability, is to use the 7400 to scale the position data to values that are equal the amount of liquid in the tank. The following setup assumes a 250 gallon tank 45 inches in height, a 72 inch LDT and a desired resolution of 0.01 Gallons.

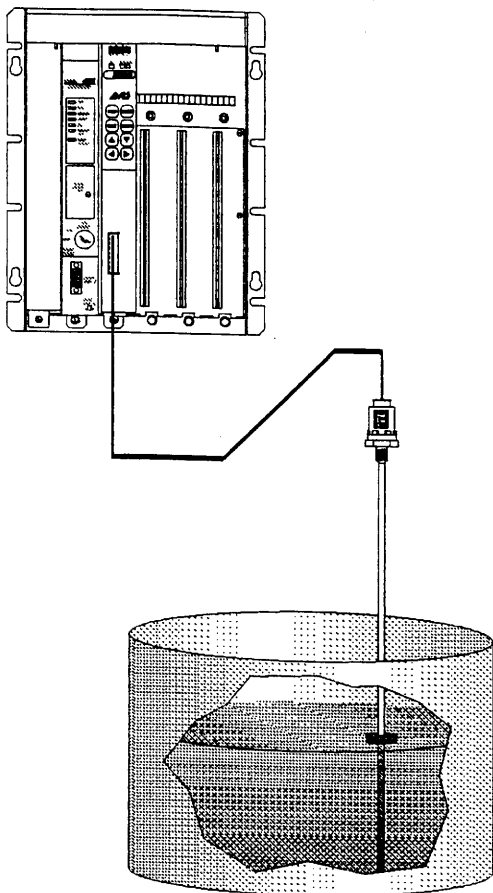

TANK CAPACITY = 250 Gallons
 TANK HEIGHT = 40 Inches
 LDT LENGTH = 72 Inches
 RESOLUTION = 0.01 Gallons

7400 PROGRAMMING

COUNT DIRECTION: Negative. Position decreases as magnet moves from head.
 F. S. LENGTH: 40 Inches
 F. S. COUNT: 25000 (250 ÷ 0.01)
 POSITION OFFSET: Approx. 15000. Exact Offset calculated with AUTO PRESET Feature.
 CONNECTION TYPE: RPM assumed. Depends on Personality Module in LDT.
 DPM RECYCLES: Not used with RPM Module. If DPM is used, must be set to 4.
 MEASUREMENT UNIT: Inches.
 LDT GRADIENT: Transducer Dependent.
 DECIMAL POINT: 2.
 PRESET VALUE: 25000.
 SPEED AVERAGE: 240 mSec. Velocity scaled to Hundredths of Gallons per Sec.
 AUTO PRESET: Tank filled with 250 Gallons of liquid. [CLEAR] Key is pressed while displaying the Position. Offset is calculated to bring Position to "250.00".

Fig. 3.2 7400 Application

Front Panel Description

The following is a description of the features found on the Series 7400 Modules. Separate sections of this chapter describe the parts in detail. Unless otherwise noted, all information presented in this chapter is applicable to all of the modules in the 7400 Series.

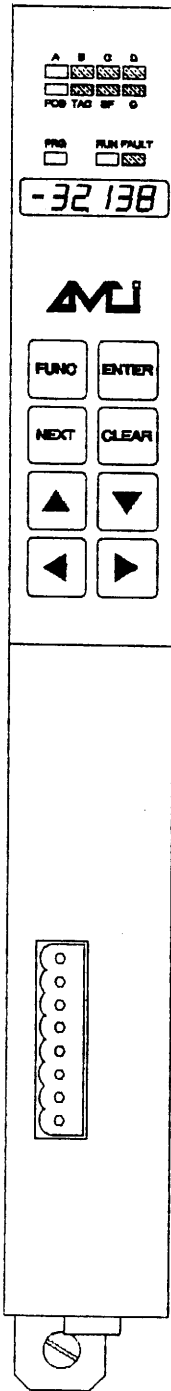

Function Display - Used to show the Functions and Parameters of the 7400 Module. The eight LED indicators designate what is showing on the alpha-numeric display. When you are in Program Mode, a blinking digit on the alpha-numeric display shows the position of the Cursor.

Status Indicators - Indicates the operating condition of the module.

PRG - Yellow light is on when the module is in Program Mode.

RUN - Green light is blinking when the module is operating.

FAULT - Red light is on when there is a fault condition. The nature of the fault is shown on the alpha-numeric display.

Program Switch - Located on the top panel, hidden from view. Used to enable or disable Program Mode. When enabled, the module is programmable from the keyboard.

Keyboard - Used to examine or change the Functions and Parameters of the module.

Transducer Input Connector - Connector for the MTS Temposonics LDT Transducers.

Fig 2.1 7400 Front Panel

Function and Parameter Displays

The following displays are available on the 7400 Modules. A brief description of each Function or Parameter is given to the right of the display. Unless noted, each of the displays is available on all of the 7400 Modules. Please note that a shaded LED indicator is not lit in the display.

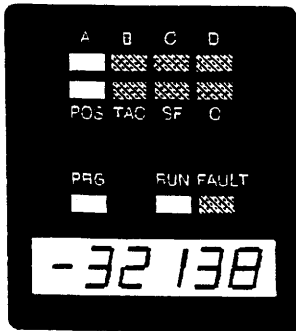

Fig 2.2 Position Display

Position Data Display - This display shows the current position of the magnet along the LDT's shaft. Its value is based on the displacement from the magnet's programmed zero point. Maximum/Minimum value is $\pm 99,999$. If the Position Data becomes greater than 99,999 the Position display will change to "End ". If the Position Data becomes less than -99,999 the Position Display will change to "-End ". If you are using a 7452 Module, the Position Data Display for the additional transducer is sequentially available by pressing the [NEXT] Key. The "A" Indicator LED on the display indicates transducer 1 while the "B" Indicator LED indicates transducer 2. Position data is available to the Processor.

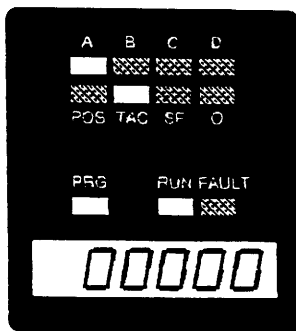

Fig 2.3 Velocity Display

Velocity Data Display - This display shows the velocity of the magnet along the LDT's Shaft in Counts/Second. The time between updates, which is the time it takes to determine the new velocity and show it on the display is set by the Speed Average parameter. If you are using a 7452 Module, the Velocity Data Display for the additional transducer is sequentially available by pressing the [NEXT] Key. The "A" Indicator LED on the display indicates transducer 1 while the "B" Indicator LED indicates transducer 2. Velocity data is available to the Processor.

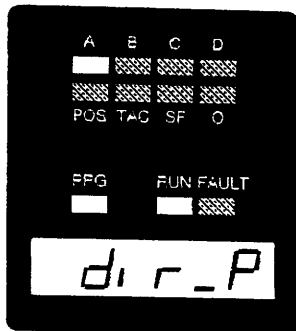

Fig 2.4 Count Direction

Count Direction Parameter - Sets the direction, relative to the head of the LDT, that the magnet must travel to increment the Position Data. When the Count Direction is positive, ("P" on the display), the Position Function will increment when the magnet travels away from the LDT's head. When the Count Direction is negative, ("n" on the display), the Position Function will increment when the magnet travels towards the LDT's head. If you are using a 7452 Module, the Count Direction Parameter for the additional transducer is sequentially available by pressing the [NEXT] Key. The "A" Indicator LED on the display indicates transducer 1 while the "B" Indicator LED indicates transducer 2.

Function and Parameter Displays (cont'd)

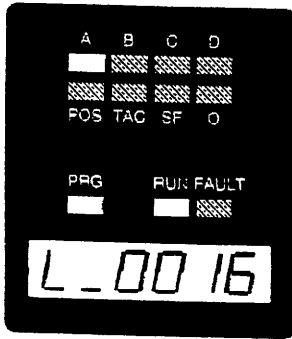

Fig 2.5 FS Length Display

Full Scale Length Parameter - Programmable in inches or millimeters, this parameter is the distance that you expect the magnet to travel. Maximum values of this parameter is 2600 inches or 9999 mm. Minimum values are 2 inches or 50 mm. Before this parameter is programmed, the Measurement Unit Parameter (See Pg 2-5) should be programmed appropriately. If you are using a 7452 Module, the Full Scale Length Parameter for the additional transducer is sequentially available by pressing the [NEXT] Key. The "A" Indicator LED on the display indicates transducer 1 while the "B" Indicator LED indicates transducer 2. When this parameter is entered, the Full Scale Count parameter defaults to the maximum resolution allowed for the specified length. See *Specifications* Pg. 2-12.

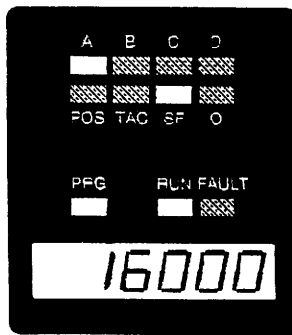

Fig 2.6 FS Count Display

Full Scale Count Parameter - This parameter sets the number of counts over the specified Full Scale Length. The position resolution is equal to the Full Scale Counts / Full Scale Length. When the Full Scale Length parameter is entered, the Full Scale Count defaults to the maximum resolution allowed for the specified length. If you are using a 7452 Module, the Full Scale Count Parameter for the additional transducer is sequentially available by pressing the [NEXT] Key. The "A" Indicator LED on the display indicates transducer 1 while the "B" Indicator LED indicates transducer 2.

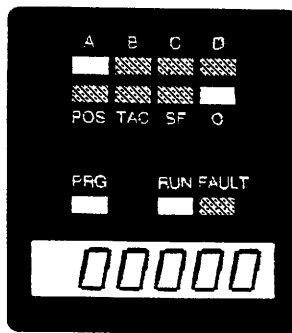

Fig 2.7 Position Offset

Position Offset Parameter - This parameter is used to set a reference point for the Position Function to start from. Max/Min values for the Position Offset are $\pm 99,999$. This parameter is most often used to set the zero position on the LDT probe. If you are using a 7452 Module, the Position Offset Parameter for the additional transducer is sequentially available by pressing the [NEXT] Key. The "A" Indicator LED on the display indicates transducer 1 while the "B" Indicator LED indicates transducer 2.

Function and Parameter Displays (cont'd)

SETUP PARAMETERS

These parameters are only available when the module is in Program Mode (See *Program Switch* Pg. 2-9 for more information.) These parameters contain information that would not be changed often once the system is running.

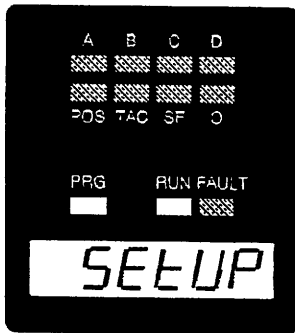

Fig 2.8 Setup Display

Setup Parameter Display - When this display is shown, press the [ENTER] Key to gain access to the Setup Parameters. Pressing the [FUNCTION] key will return you the the Position Function display.

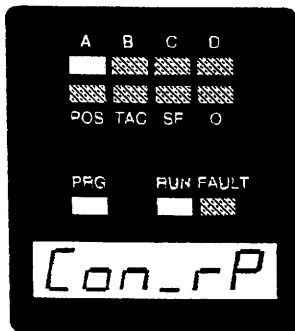

Fig 2.9 Connection Type

Connection Type Parameter - This parameter tells the 7400 which supported Personality Modules is installed in the head of the LDT. Presently, RPM and DPM Personality Modules are supported by the 7400 Module. If you are using a 7452 Module, the Connection Type Parameter for the additional transducer is sequentially available by pressing the [NEXT] Key. The "A" Indicator LED on the display indicates transducer 1 while the "B" Indicator LED indicates transducer 2. The Personality Modules in the two LDT's can be different.

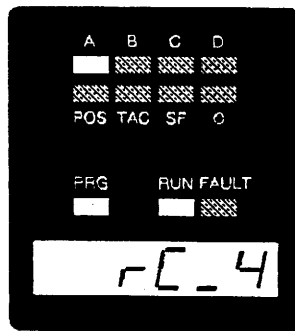

Fig 2.10 DPM Recirculations

DPM Recirculations - This parameter is available only when a DPM module is selected as the Connection Type. This parameter is used to tell the 7400 how many Recirculations the DPM Module is configured for. This parameter must equal the number of recirculations that the DPM is set for or the Position data will not be valid. Allowable values for this parameter are 1, 2, or 4 recirculations. If you are using a 7452 Module, the DPM Recirculations parameter for the additional transducer is sequentially available by pressing the [NEXT] Key. The "A" Indicator LED on the display indicates transducer 1 while the "B" Indicator LED indicates transducer 2. Also, the DPM Recirculations parameter for the two LDT's can be different.

Function and Parameter Displays (cont'd)

SETUP PARAMETERS (cont'd)

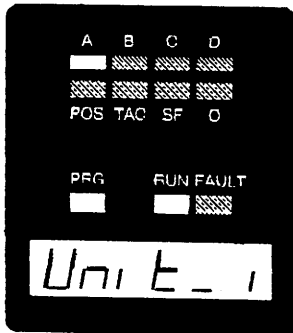

Fig 2.11 Measurement Unit

Measurement Unit Parameter - Specifies the measurement unit as inches or millimeters. Changing this parameter will reset all parameters, except Connection Type and Speed Average, to their default values. If you are using a 7452 Module, the Measurement Unit parameter for the additional transducer is sequentially available by pressing the [NEXT] Key. The "A" Indicator LED on the display indicates transducer 1 while the "B" Indicator LED indicates transducer 2. The Measurement Unit parameter for the two LDT's can be different.

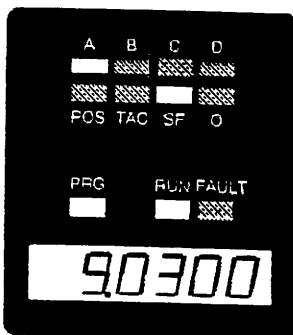

Fig 2.12 LDT Gradient

LDT Gradient Parameter - This is a calibration parameter supplied by MTS. It is the rate at which the return pulse propagates down the transducers' length. The value of the LDT Gradient is printed on the head of the MTS transducer. If the LDT was ordered with a length specified in inches, the LDT Gradient is given in microseconds/inch. If the LDT was ordered with a length ordered in millimeters, the LDT Gradient is given in microseconds/mm. The Measurement Unit parameter (see above) should be programmed appropriately before this parameter is entered. If this parameter is not programmed to be equal to the value printed on the transducers' head, the 7400 will not calculate accurate distances. If you are using a 7452 Module, the LDT Gradient parameter for the additional transducer is sequentially available by pressing the [NEXT] Key. The "A" Indicator LED on the display indicates transducer 1 while the "B" Indicator LED indicates transducer 2.

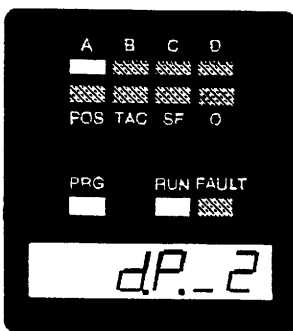

Fig 2.13 Decimal Point

Decimal Point Parameter - This parameter sets the position of a decimal point on the Position, Full Scale Counts, Position Offset, and Preset Value displays. The value of the Decimal Point Parameter sets the number of digits to the right of the decimal point. Maximum value is 5 digits. If you are using a 7452 Module, the Decimal Point parameter for the additional transducer is sequentially available by pressing the [NEXT] Key. The "A" Indicator LED on the display indicates transducer 1 while the "B" Indicator LED indicates transducer 2.

Function and Parameter Displays (cont'd)

SETUP PARAMETERS (cont'd)

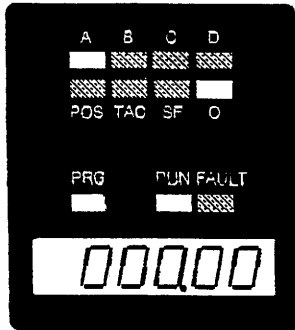

Fig 2.14 Preset Value

Preset Value Parameter - This parameter specifies the value that the Position Function will change to when the Auto Preset feature is used. (See *Auto Preset* Pg. 4-6) The values of this parameter range from $\pm 99,999$. If you are using the 7452 Module, the Preset Value parameter for the additional transducer is sequentially available by pressing the [NEXT] Key. The "A" Indicator LED on the display indicates transducer 1 while the "B" Indicator LED indicates transducer 2. The Auto Preset feature is most commonly used to set the Position Function to the correct value when the LDT is at it's home or zero position.

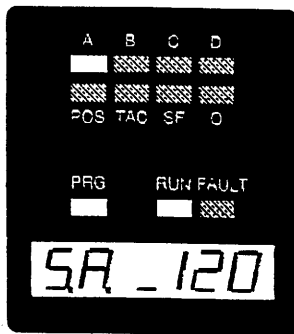

Fig 2.15 Speed Average

Speed Average Parameter - This parameter sets the update time of the 7400's Velocity Function. Update time is the amount of time that the Module totals the change in position of the magnet before calculating the velocity of the magnet in Counts per Second. Programmable values for this parameter are 32, 60, 120, and 240 mSec. If you are using the 7452 Module, the Speed Average parameter for the additional transducer is sequentially available by pressing the [NEXT] Key. The "A" Indicator LED on the display indicates transducer 1 while the "B" Indicator LED indicates transducer 2.

Status Indicators

There are three single LED indicators below the alpha-numeric display that show the operating status of the module. The Status bits of the Registers assigned to the module are used to report status information to the processor.

PRG: This yellow light is on when the module is in Program Mode. While in Program Mode, all of the parameters can be inspected and altered from the keyboard.

RUN: A blinking green light indicates that the module is powered and operational.

FAULT: This red light is on when the module recognizes that a fault condition exists. The type of fault is shown on the alpha-numeric display. The Series 7400 Modules recognize three types of faults.

ERROR CLASSES:

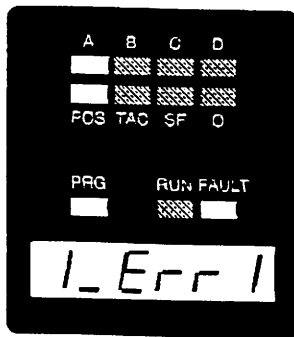

Fig 2.16 Xducer Fault

Error Class 1:

Transducer Fault - This message is shown only when the module is displaying the Position or Velocity Data Functions. The Parameters will be displayed normally. This error is automatically cleared by the 7400 once the LDT responds to Interrogation Pulses. There are four major causes of this fault.

- Magnet in Null or Dead Zone of LDT.
- Broken Transducer Cable.
- Improper wiring of the Transducer Cable.
- Faulty Transducer.

On multi-axis modules, the transducer fault may not be on the axis that is being shown on the modules' display. In this case, the fault light will be on but the module will be displaying Position and Velocity information. Use the [NEXT] Key to cycle through the modules' axes until the fault is found.

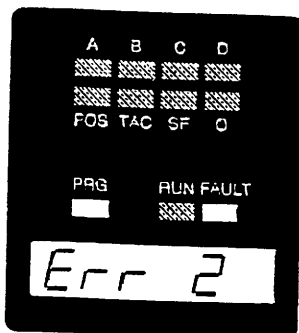

Fig 2.17 E² PROM Fault

Error Class 2:

E² PROM Fault - This message is displayed at all times. The module recognizes that the program data (Scale Factor, Offsets, etc.) is incorrect. This error can be cleared by pressing the [CLEAR] Key. If the " Err 2" message remains after pressing the [CLEAR] Key, the E² PROM memory is damaged and the module must be returned for repairs. See inside front cover *Returns Policy*: for additional information.

Status Indicators (cont'd)

ERROR CLASS 3: RAM Fault - Not implemented on the Series 7400 Modules. Reserved for future expansion.

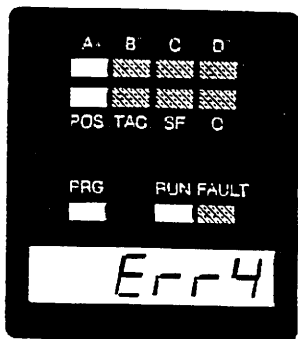

Fig 2.18 P.S. Fault

Error Class 4:

Power Supply Shut-down Fault - Shown only when the module is displaying the Position and Velocity Data Functions. The parameters will be displayed normally. This error occurs when the current draw from the power supply is to large and the Module turns the DC-DC converter off. There are three major causes of this fault.

- Short across Transducer cable.
- Mis-wired Transducer Cable.
- Faulty Transducer.

If your module has a Serial # 10148 or above, the fault message will clear itself when the fault condition is removed. If your module's serial number is below 10148, you must press the [CLEAR] Key to clear the fault. If you are using the 7452, a fault on one transducer will also shut down the other.

OVERFLOW/UNDERFLOW INDICATION

The value of the Position Function is limited to $\pm 99,999$. Under certain circumstances, it is possible to increment or decrement the Position value beyond these limits. When this occurs, the Position and Velocity Functions change to one of the following:

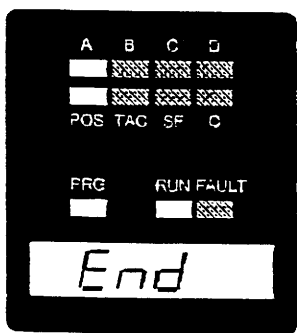

Fig 2.19 Position Overflow

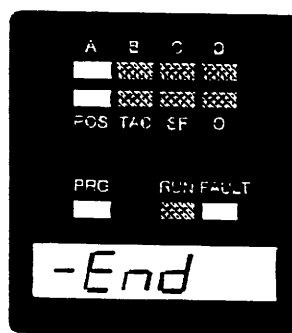
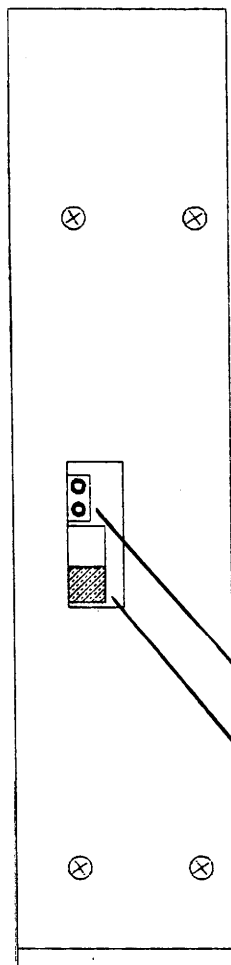

Fig 2.20 Position Underflow

The Position and Velocity displays will automatically show data once the magnet's position has moved or one or more of the Parameters has been changed. Overflow/Underflow indication is also set to the Processor. See Data Format Pg. 5-1 for further information.

Program Switch

The Program Switch is used to enable or disable programming of the 7400 Module. The module is programmable (Program Mode, PRG light ON) when the switch is pushed towards the back of the module. When in Program Mode, all parameters can be modified. The module is not programmable (Display Mode, PRG light OFF) when the switch is pushed towards the front of the module. When in Display Mode, the Count Direction, FS Length, FS Count, and Position Offset can be examined but cannot be modified.



WARNING: Remove system power before removing or installing a module in the I/O Rack. Failure to observe this warning can result in damage to the module's circuitry and/or undesired operation with possible injury to personnel.

The Program Switch can be disabled by removing the jumper on the two pin header next to the switch. Removing this jumper locks the 7400 in Display Mode. It is suggested that this jumper be removed once the system is operational. This will prevent someone from accidentally changing the 7400's parameters while the system is running. The only times that changes to the modules programming should be allowed are during set-up or trouble shooting procedures.

Two Pin Header shown with Jumper installed.

Program Switch shown in Program Mode position.

Fig 2.21 Program Switch

Keyboard Description

The following table describes what the keys do when you are in Display Mode, (PRG light OFF) or Program Mode (PRG light ON).

When in Program Mode, a parameter that you show on the display can be changed if one of the digits on the display is blinking. The blinking digit shows the position of the Cursor.







KEY	DISPLAY MODE	PROGRAM MODE
	Use this key to select the function or parameter you wish to show on the display.	Same as Display Mode.
	Not used in Display Mode.	If a parameter is shown with a Cursor, pressing this key will store the displayed value in E ² PROM Memory.
	Use this key to recover from fault conditions. The exact nature of the fault is shown on the display. See 'Status Indicators'.	1) Same as Display Mode. 2) If the Position Function is on the display, press this key to use the AUTO PRESET Feature.
	Used to switch between the additional transducers on a 7452 module.	1) Same as Display Mode 2) 7451 Only. Pressing this key will recall a Parameters last entered value and reset the Cursor.
	Not used in Display Mode.	If the Cursor is shown, use these keys to increment [▲] or decrement [▼] the number under the Cursor.
	Not used in Display Mode.	If the Cursor is shown, use these keys to move the Cursor one digit to the left, [◀], or the right, [▶].

Fig 2.22 Keyboard Description

Transducer Input Connector

The Transducer Input Connector on the Series 7451 single axis Modules has eight contacts while the Transducer Input Connector on the Series 7452 dual axis Modules has fourteen contacts. The following table lists the AMCI and Phoenix Contact part numbers on the mating connectors:

	7451 Module Eight Pin Conn.	7452 Module 14 Pin Connector
AMCI #	MS - 8	MS - 14
Phoenix #	MSTB1.5/8-ST-5.08	MSTB1.5/14-ST-5.08

The pin-out of the cables are given in Chapter 3, Installation.

Fuse Replacement

If the Power Fuse fails, it can be easily replaced. The factory installed fuse is a 2 Amp Fast Blow, Littelfuse Part Number 225002. Fuse kits are available from AMCI. The AMCI Part # is SKF-6. Each fuse kit contains five fuses.



CAUTION: To insure continued and adequate protection, any replacement fuse must have a rating of 2 Amp Fast Blow. Using a higher ampere rating or slow blow fuses may not protect the module from damage if the fault conditions are again applied to the module.



WARNING: Remove system power before removing or installing a module in the I/O Rack. Failure to observe this warning can result in damage to the module's circuitry and/or undesired operation with possible injury to personal.

Refer to the figure below for the location of the power fuse.

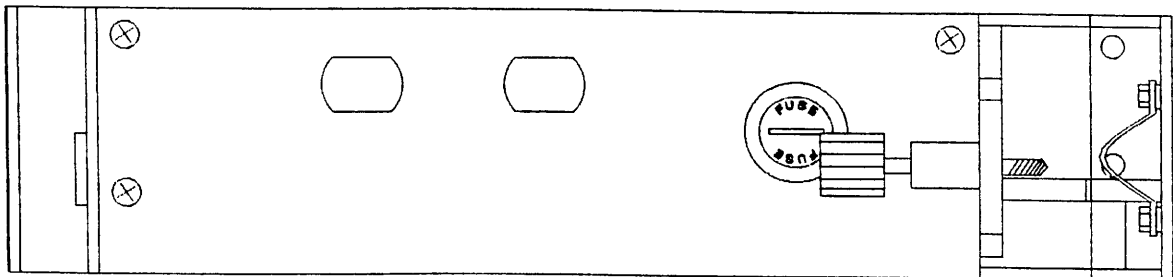

Fig 2.23 Power Fuse

Specifications

Module Location

Any SY/MAX[®] Register Slot

Position Transducer

MTS Temposonics™ LDT

Supported Personality Modules

DPM: Digital Personality Module

RPM: Start/Stop Personality Module

Transducer Input

Optically Isolated (1500 Vac)

Number of Recirculations

1: Resolution $\leq 0.01"$

2: Resolution $> 0.01"$ and $< 0.002"$

4: Resolution $\geq 0.002"$ and $\leq 0.001"$

Programmable Parameters

Count Direction

Full Scale Length

Full Scale Count

Position Offset

Connection Type

DPM Recirculations

Measurement Unit

LDT Gradient

Decimal Point Position

Preset Value

Speed Average

Measurement System

Programmable to Inches or Millimeters

Position Resolution

To 0.001 inches: LDT Length < 99 inches

To 0.01 inches: LDT Length < 600 inches

To 0.1 inches: LDT Length < 2600 inches

Position Offset

Programmable to any point on LDT's Length.
Used to set the reference position on the LDT.

Velocity Data Response Time

Programmable to 32, 60, 120, or 240 mSec

Velocity Data Resolution

Determined by, and identical to, the Position Resolution

Velocity Data Range

0 to 99999 Counts/sec

Data Available to Processor

Magnet Position, Magnet Velocity,
and Fault Diagnostics

Program Input

Module's self-contained keyboard and display

Program Storage

EEPROM Memory

DC Supply Voltage from Backplane

+5 Volts @ 1.50A max. (7452 Module)

Module's +5V DC Supply Fuse

2A Fast Blow (Littelfuse 225002)

Environmental Conditions

Operating Temperature: 0 to 60° C.

Relative Humidity: 5 to 95%
(without condensation)

Storage Temperature: -40 to 85° C.

Connector Keying

Pin 1: Between slot (03-04) and slot (05-06)

Pin 2: Between slot (29-30) and slot (31-32)

Pin 3: Between slot (91-92) and slot (93-94)

Power Requirements

A Series 7400 Module draws its power from the I/O Rack back-plane +5 Vdc Supply. The maximum current draw by a 7400 Module is 1.50 Amp. Add this to the power requirements of all other cards in the rack to avoid exceeding backplane or supply capacity.

Installing the Module

The Series 7400 Modules can be installed in any available Register Slot in a Square D I/O Rack. These I/O Racks are:

Register Racks:	RRK-100	RRK-200	RRK-300
Digital I/O Racks:	CRK-210	CRK-300	DRK-210
	DRK-300	GRK-110	GRK-210
	HRK-100	HRK-150	HRK-200.

The Series 7400 Modules cannot be installed in slot 1 of the Register Racks. When installed in Digital I/O Racks, the Series 7400 Modules must be installed in the rack's Register Slot.

The following keying pins should be installed in the Register Slot connector that the Series 7400 Module will reside in. This will insure that only an AMCI Series 7400 Module can be plugged into the slot.

- Pin 1: Between slots (03-04) and (05-06)
- Pin 2: Between slots (29-30) and (31-32)
- Pin 3: Between slots (91-92) and (93-94)

Note: Use care when inserting or removing keying pins and avoid touching the contact fingers within the connector. Improper insertion or removal of the pins may damage the connector.

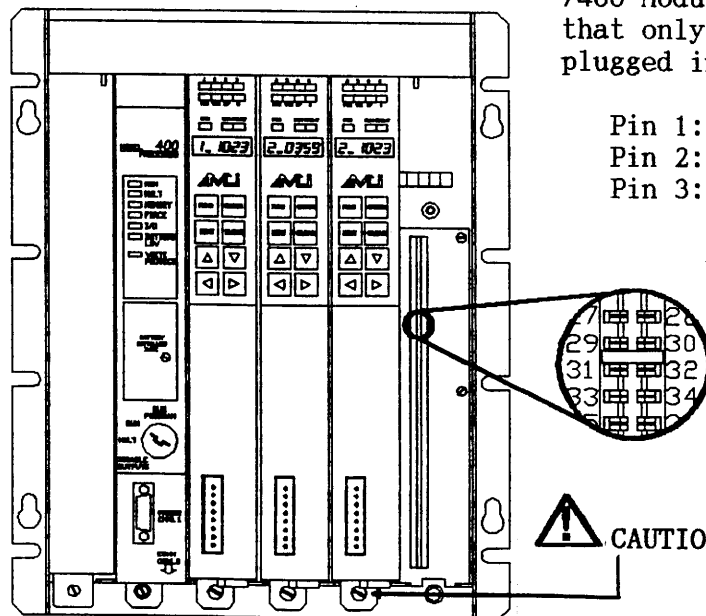

CAUTION: The Grounding Screw must be screwed into the chassis tightly in order to insure safe and proper operation.

Fig 3.1 Installing 7400 Module

Addressing the 7400 Modules

Before a Series 7400 Module can communicate with a Square D programmable controller, you must assign register numbers to the slot that the module is plugged into. The number of registers that must be assigned to the slot is dependent on the type of 7400 Module. The following table lists the minimum number of registers that can be assigned to the module.

Number of Registers

Module #	# of Registers
7451	4
7452	8

Fig. 3.2 Register Assignment Table

These registers transfer position and velocity data back to the processor. A detailed description of the data format can be found in Chapter 5, "Series 7400 Data Format".

The process of assigning register numbers to the slots is called RACK ADDRESSING. Rack Addressing is accomplished from your CRT Programmer. The actual steps involved in Rack Addressing are different for each model of Square D processors. Please refer to the appropriate instruction bulletin for each type of SY/MAX programmer.

The Series 7400 Modules appear as Input modules to the SY/MAX controller. When the Rack addresses are specified on the CRT Programmer, using the CPU or REMOTE RACK ADDRESS ASSIGNMENT Displays, the "MODULE INFO" comment should read "IN D5" if a transducer is attached and the module is operating correctly. "D5" is the hexadecimal code specified by Square D for third party Input Modules.

The Series 7400 Modules use the Status Bits to report fault diagnostics data to the processor. If a working transducer is not attached to the 7400 module when the processor is powered up, the Status Bits will equal "61h" instead of "D5h" and the processor will halt with a slot fault.

Compatible Transducers

Presently, the Series 7400 Modules have been tested with Temposonics II LDTs. A 7400 Module will interface with a Temposonics II as long as it has a RPM or DPM Personality Module installed in its head.

DPM Setup

Switches that are located on the DPM are used to configure it for various resolutions and internal or external interrogation. You should refer to MTS documentation for specifics on configuring the module. The 7400 Series require that the DPM be configured for External Interrogations. Switches 1 and 2 on the DPM are used to set the number of recirculations. Refer to the Table below to determine the number of recirculations required for a desired resolution and the proper switch settings.

Resolution	Recirculations	Switch Settings: SW2 = 8
$\leq 0.01"$	1	SW1 = 1
$>0.01" <0.002"$	2	SW1 = 2
$\geq 0.002 \leq 0.001"$	4	SW1 = 4

Fig. 3.3 DPM Personality Module Switch Settings

Transducer Mounting

Refer to the MTS documentation that you received with your Temposonics transducer for the proper mounting requirements.

Transducer Cable Numbers

MTS specifies BELDEN #8105 cable for the Temposonics II transducers. Cables can be ordered directly from MTS.

Temposonics II Cabling

7451 Single Axis Transducer Cable

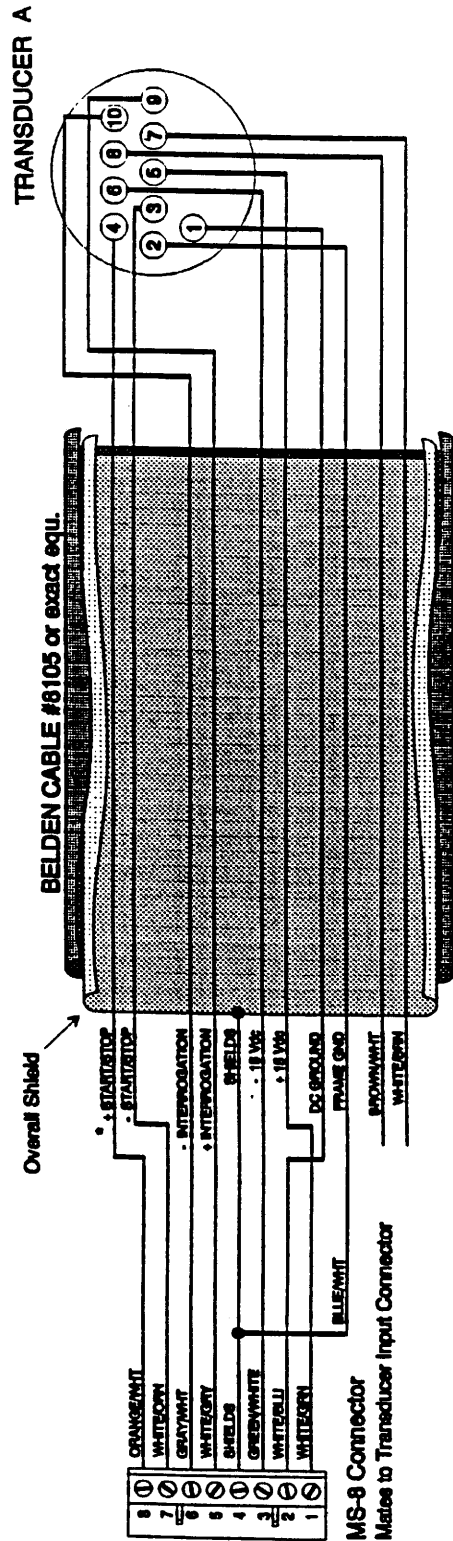

7400 AND 7900 USERS:

Pin 1 of the Transducer Input Connector is located toward the top of the 747900 Module, NOT the bottom as this drawing may imply. Reversing the wires from the LDT will not harm the 747900 Module, but it may damage the Personality Module in the LDT.

* Cable for Transducers with RPM Personality Module is shown.
 For Transducers with DPM Personality Module, the following pins are renamed:
 + Start/Stop renamed to + Gate Out
 - Start/Stop renamed to - Gate Out

Fig 3.4 Single Axis Transducer Cable

Temposonics II Cabling

7452 Two Axis Transducer Cable

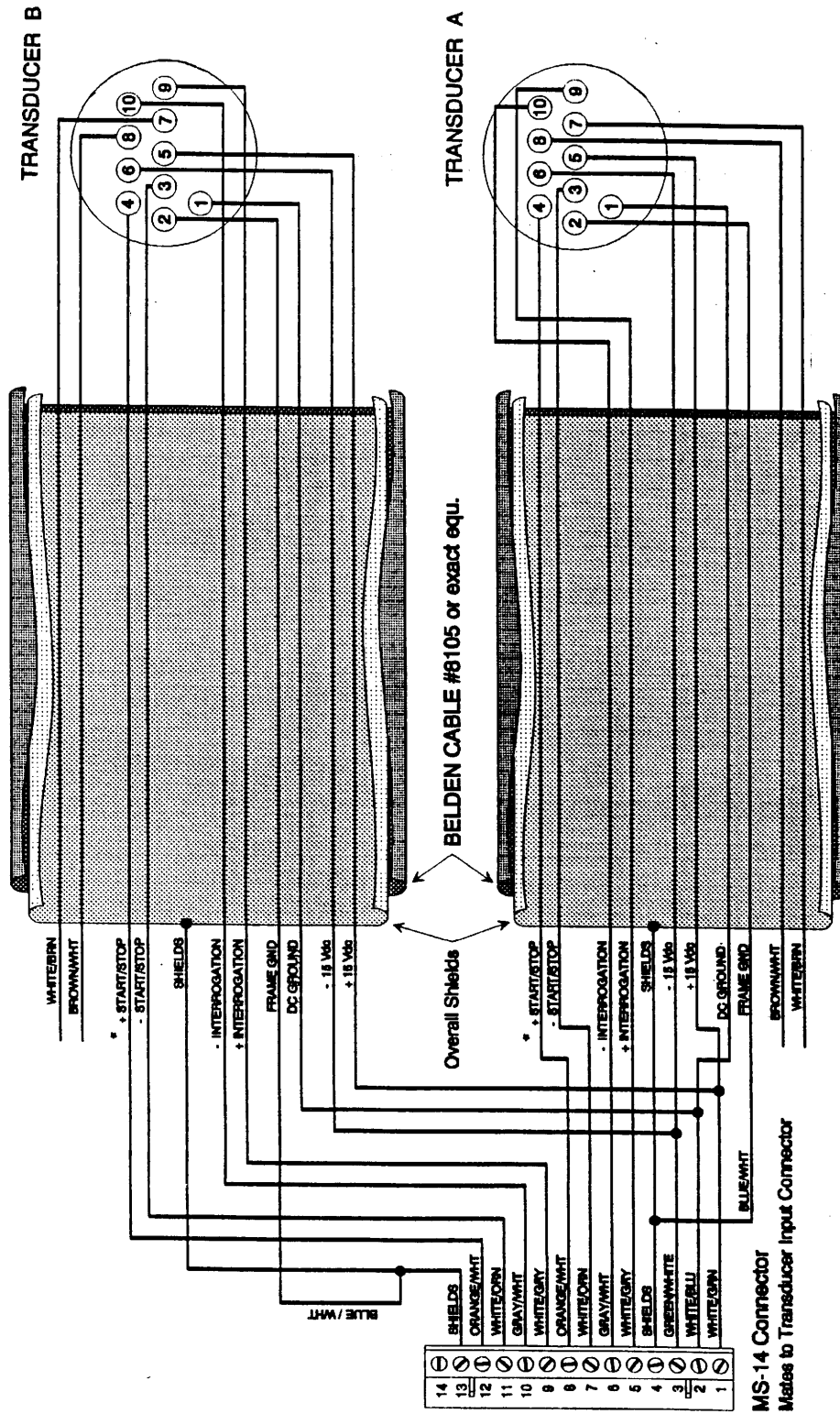

7400 AND 7900 USERS:
Pin 1 of the Transducer Input Connector is located toward the top of the 74/7900 Module, NOT the bottom as this drawing may imply. Reversing the wires from the LDT will not harm the 74/7900 Module, but it may damage the Personality Module in the LDT.

* Cable for Transducers with RPM Personality Module is shown.
For Transducers with DPM Personality Module, the following pins are renamed:
+ Start/Stop renamed to + Gate Out
- Start/Stop renamed to - Gate Out.

Fig 3.5 Dual Axis Transducer Cable

Notes:

This chapter offers examples on how to program the Series 7400 modules. Unless noted, all programming examples are applicable to all Series 7400 Modules.

Before any of the Series 7400's parameters can be programmed, the module must be in Program Mode. (Program Switch set "ON". See *Program Switch* Pg. 2-9 for more information.) When the module is in this mode, the yellow PRG light on the front panel is lit.

Conventions

The following conventions are used when describing the keystrokes needed to program the different parameters.

[KEY]: Used to show the key pressed on the module.
The key's name will be inside the brackets.

If an asterisk appears before a key, (Example: *[FUNCTION]), the key must be pressed until the display matches what is shown in the instructions.

If a "X" and a number follow a key, (Example: [▲]X3), the key must be pressed the shown number of times. (In this example, the [▲] key would be pressed 3 times.)

IND. LEDS: Indicator LEDs that indicate the function or parameter being displayed or programmed.

"Display": Information shown on the 6 digit display.
The blinking cursor is shown by an underline

The following keystroke examples use the least number of keystrokes. However, any series of keystrokes is valid as long as the data is correct before the [ENTER] key is pressed.

In these examples, except where noted, the parameters are programmed to the values listed in *Application Notes*: Pg. 1-4.

Count Direction

You are using the Temposonics LDT to measure the liquid level in a 250 gallon cylindrical tank to 0.01 gallons. See *Application Notes*: Pg. 1-4. The transducer is mounted above the tank so you need the position values to decrease as the magnet moves away from the LDT head. You can accomplish this by changing the Count Direction Parameter to "negative".

PRESS	IND. LED	DISPLAY	COMMENTS
*[FUNCTION]	A	" dir_P"	Present value.
[▲]	A	" dir_n"	Parameter changed to negative count direction.
[ENTER]	A	" dir_n"	Value stored in E ² PROM. Blinking cursor removed.

Full Scale Length

The LDT length is 72 inches but only 40 inches of the probes' length will be used. Instead of entering the length of the LDT you can enter the distance that the LDTs' magnet will travel. In this case, it simplifies the calculations needed to determine the Full Scale Count.

PRESS	IND. LED	DISPLAY	COMMENTS
*[FUNCTION]	A	"L_0016"	Default value.
[▶]X2, [▲]X3, [▶], [▲]X4, [ENTER]	A	"L_0040"	Value stored in E ² PROM. Blinking Cursor removed.

Full Scale Count

In most applications, the Full Scale Count is simply the Full Scale Length multiplied by a power of ten. This gives a position value that reads out directly in the desired unit of length. This is not the case for the example in *Application Notes*: where the Position Function reads out in hundredths of gallons. 250 Gallons multiplied by 100 Counts per Gallon equals 25000 Counts.

PRESS	IND. LED	DISPLAY	COMMENTS
*[FUNCTION]	SF + A	" <u>40000</u> "	Default for 40" Length.
[▼]X2, [▶] [▲]X5, [ENTER]	SF + A	" 25000"	Value stored in E ² PROM. Blinking Cursor removed.

Position Offset

The Position Offset is used to change the value of the Position Function without moving the LDTs' magnet.

There is a True Position that the 7400 reads from the LDT. This position is the distance between the magnet and the return pulse detector located in the LDTs' head. Due to the manufacturing process, the True Position can vary from probe to probe by a small amount. The value of the Position Function is equal to the Position Offset added to the True Position. Note that the signs of the Position Offset and True Position are significant.

In most cases, you can use the Auto Preset to set the value of the Position Function instead of calculating the Position Offset. Using the Auto Preset, the Position Offset will be automatically calculated by the 7400. It is then simple, if necessary, to vary the Position Offset by small amounts from the Position Offset display.

In this example, the Position Offset is equal to 168.59 and must be changed to 168.48. If the Position Function was 125.59 it will now read 125.48. If the Position Function read -125.59, it will now read -125.70.

PRESS	IND. LED	DISPLAY	COMMENTS
*[FUNCTION]	O + A	" <u>16859</u> "	Present Offset Value.
[▶]X3, [▼], [▶], [▼], [ENTER]	O + A	" 16848"	Value Stored in E ² PROM. Blinking Cursor removed.

Connection Type

You are using a LDT that contains a DPM Personality Module. Presently, the 7400 has its' default configuration for a RPM Personality Module.

PRESS	IND. LED	DISPLAY	COMMENTS
* [FUNCTION]	A	"Con_rP"	Default Configuration.
[▲], [ENTER]	A	"Con_dP"	Value Stored in E ² PROM. Blinking Cursor removed.

DPM Recirculations

If a DPM Personality Module is used, the number of recirculations that it is set for must also be programmed into the 7400. Possible numbers are 1, 2, and 4 recycles. When the Full Scale Length or Full Scale Count parameters are modified, the DPM Recirculations will automatically set to the minimum allowable value for the chosen resolution. The LDT can be set for a higher number of recirculations without effecting the resolution, but the position update time will be longer. The minimum number of recirculations needed for a desired resolution is listed in *Specifications*: Pg 2-12.

IT IS IMPERATIVE THAT THE NUMBER OF RECIRCULATIONS SET ON THE DPM MODULE AND DPM RECIRCULATIONS PARAMETER BE EQUAL. IF THEY ARE NOT, THE 7400 WILL NOT CALCULATE CORRECT POSITION OR VELOCITY DATA.

For example, to simplify your ladder logic program, you decide to limit your position values from 20 bits to 12 bits. Changing the Full Scale Count decreases the number of recirculations from 4 to 2. Instead of opening the LDT to change the DPM switch settings, you decide to reset the DPM Recirculations Parameter to 4.

PRESS	IND. LED	DISPLAY	COMMENTS
* [FUNCTION]	A	" rC_2"	Present Value.
[▲], [ENTER]	A	" rC_4"	Value stored in E ² PROM. Blinking Cursor removed.

Measurement Unit

You are using a LDT that has its length and Gradient specified in millimeters. In order to simplify programming, you can change the Measurement Unit from the default of inches to millimeters.

Changing this parameter will reset all other parameters to their default values except the Connection Type and Speed Average parameters.

PRESS	IND. LED	DISPLAY	COMMENTS
*[FUNCTION]	A	"Unit_i"	Present Value.
[▲], [ENTER]	A	"Unit_d"	Value stored in E ² PROM. Blinking Cursor removed.

LDT Gradient

The LDT Gradient is the velocity at which the return pulse propagates down the length of the transducer shaft. The value of the LDT Gradient varies from transducer to transducer. Its value is printed on the label of the Temposonics transducer.

In this example, the LDT Gradient printed on the label is 8.9986 uSec per Inch. Presently, the default value of 9.0300 is stored in memory.

PRESS	IND. LEDS	DISPLAY	COMMENTS
*[FUNCTION]	SF + A	" 9.0300"	Present Value.
[▼], [▶], [▼] [▶], [▼]X4, [▶], [▼]X2, [▶] [▼]X4, [ENTER]	SF + A	" 8.9986"	Value stored in E ² PROM. Blinking cursor removed.

Decimal Point Position

You want to program a Decimal Point so that the last two digits on the position display are after it. The parameter presently has its default setting of 0.

PRESS	IND. LEDS	DISPLAY	COMMENTS
*[FUNCTION]	A	" d.P._0"	Present Value.
[▲]X2, [ENTER]	A	" d.P._2"	Value stored in E ² PROM Blinking cursor removed.

Preset Value

You want to program a Preset Value of 25000 Counts. Presently, the default value of zero is in memory.

PRESS	IND. LED	DISPLAY	COMMENTS
*[FUNCTION]	O + A	" 00000"	Default Value.
[▲]X2, [▶], [▼]X5, [ENTER]	O + A	" 25000"	Value Stored in E ² PROM. Blinking Cursor removed.

Auto Preset Feature

The Position Function can be forced to equal the Preset Value Parameter without the need to calculate the position Offset. This allows you to quickly set a reference position on the LDT. In the example in the *Applications Notes* this reference point is 250.00 and corresponds to the cylindrical tank being full.

In order to use the Auto Preset Feature, you must have the 7400 in Program Mode and the Position data must be shown on the display.

PRESS	IND. LED	DISPLAY	COMMENTS
*[FUNCTION]	POS + A	" xxx.xx"	Present Position.
[CLEAR]	POS + A	" 250.00"	Position = Preset Value
*[FUNCTION]	O + A	"yyyy.yy"	Calculated Offset. Offset may be negative.

Speed Average

You wish to change the Speed Average from it's default setting of 120 mSec to 240 mSec. The Speed Average parameter sets the amount of time that the 7400 Module totals the change in position of the magnet before calculating its velocity in Counts per Second. Increasing the Speed Average will reduce the amount of "jitter" that may occur in the velocity data.

PRESS	IND. LEDS	DISPLAY	COMMENTS
*[FUNCTION]	A	"S.A. <u>120</u> "	Present Value.
[▲], [ENTER]	A	"S.A. <u>240</u> "	Value stored in E ² PROM Blinking cursor removed.

CHP 5: SERIES 7400 DATA FORMAT

Data Format

When the processor accesses the registers assigned to the 7451/2 Module, the Module transmits four 16 bit words to the processor for each of the module's axes.

BIT	16	15	14	13	12	11	10	09	08	07	06	05	04	03	02	01	
WORD 1	E*	0	0	0	0	0	U*	S*	0	0	0	0	0	0	P*		TRANS. 1
WORD 2	E*	15 Least Significant Bits Position Data											TRANS. 1				
WORD 3	E*	0	0	0	0	0	U*	0	0	0	0	0	0	0	V*		TRANS. 1
WORD 4	E*	15 Least Significant Bits Velocity Data											TRANS. 1				
WORD 5	E*	0	0	0	0	0	U*	S*	0	0	0	0	0	0	P*		TRANS. 2
WORD 6	E*	15 Least Significant Bits Position Data											TRANS. 2				
WORD 7	E*	0	0	0	0	0	U*	0	0	0	0	0	0	0	V*		TRANS. 2
WORD 8	E*	15 Least Significant Bits Velocity Data											TRANS. 2				

NOTES:

1. A 7451 will transmit only the first four words. A 7452 will transmit all 8 words.
 2. Because both the Position and Velocity values are less than 16 bits in length, both have preceding zero's to complete the 16 bit words.
- P* These two bits in the second word of the Position Data are the most significant bits of the position data. If your maximum position value is below 32767, these bits will always be zero.
- V* These two bits in the second word of the Velocity Data are the most significant bits of the velocity data. If your maximum velocity value is below 32767, these bits will always be zero.
- S* Sign Bit. Position data is transmitted in Sign/Magnitude format. This bit is set when the position data is negative.
- U* Overflow/Underflow Bit. This bit is set when the position or velocity data is outside of the $\pm 99,999$ count range. Use the sign bit to determine if the condition is an overflow or underflow. The position of velocity data shows the magnitude of the overflow or underflow.

Data Format (cont'd)

NOTES: (cont'd)

E* Error Bit. These bits are set when an error is detected by the module. All other bits are set to zero. A Transducer fault will effect only the channel that has the error. A E²PROM or Power Supply Fault will effect both channels. See Status Indicators Pgs 2-7,8 for a complete description of the error codes.

Along with the advanced features offered by the 7451 module, the 7451-01 modules offer remote display capability. You can make connection to the remote display through a fiber optic or RS-485 compatible link. Data format for the 7451-01 is different from the 7451. Therefore, the 7451-01 cannot be considered a direct replacement for the 7451.

Front Panel Description

There are two additional connectors on the front panel of the 7451-01 modules.

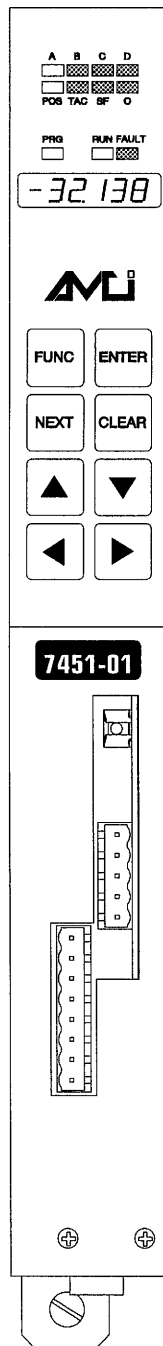

Fig A.1 7451-01 Front Panel

Fiber Optic Transmitter - Mates with Fiber Optic Cable, AMCI Part # CDP-(x) where (x) is length in meters. Maximum cable length is 75 meters (245 feet).

RS-485 Connector - Mates with RS-485 Cable AMCI Part # CDC-(x) where (x) is length in meters. Maximum Cable length is 300 meters (1000 feet). This RS-485 compatible link is electrically isolated and requires an external supply. **When connected to AMCI's 6100F Remote Display, the 6100F supplies the external power.**

Because of the positioning of the RS-485 Input Connector on the modules' front panel, a MS-8 Connector cannot be used as the Transducer Connector. A MS-8W should be used. See Print B1194 For the proper cable drawing.

Appendix A Additional Instructions: 7451-01

Fiber Optic Cable Installation

All fiber optic cables for use with the 7451-01 Modules must be manufactured by AMCI. The part number for the fiber optic cable is CDP-(x) where (x) is the length in meters. You must not splice these cables in the field. If your installation requires a splice in the cable run, order two or more cables from AMCI of the proper lengths.

Because splices in a cable cause light loss, the number of splices in a cable run effects its maximum length. The following table lists the maximum run lengths based on the number of splices. The connections to the fiber optic transmitter and receiver are not considered splices.

Number of Splices	Maximum Cable Run Length
0	75 meters (245 feet)
1	66 meters (215 feet)
2	57 meters (185 feet)
3	48 meters (155 feet)
4	35 meters (115 feet)

Fig A.2 Maximum Fiber Optic Cable Run Lengths

Complete installation information, including splice connectors can be found in the 6100F User's Manual.

RS-485 Cable Installation

A wiring diagram of the CDC-(x) {(x) = Length in Meters}, is shown in Fig. A.3. Maximum cable length is 300 Meters (1000 Feet).

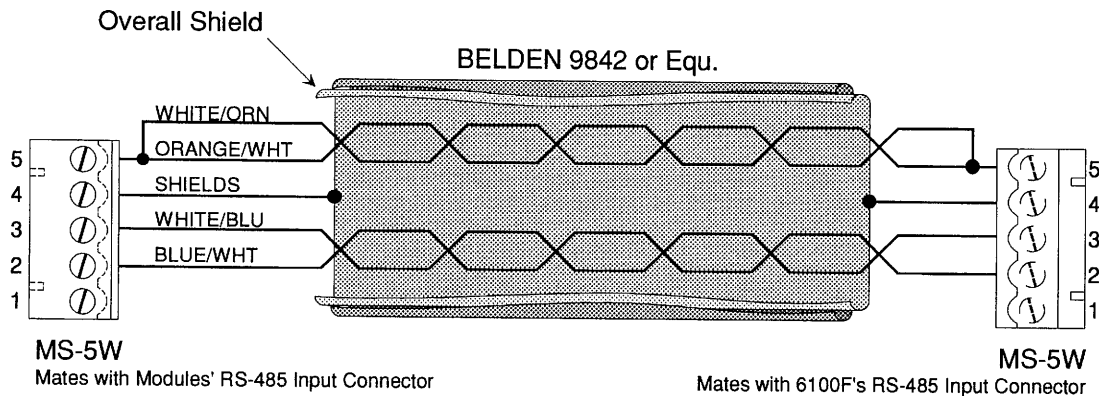

Fig A.3 CDC-(x) Wiring Diagram

If you splice the CDC-(x) Cable, it should be done in a grounded junction box. **THE SHIELD MUST BE ISOLATED FROM THE JUNCTION BOX.** If this practice is not followed, you may form a ground loop between the 6100F and the junction box that may effect the RS-485 Communications or damage the 6100F.

Additional Displays and Keyboard Programming

A 7451-01 Module has three additional parameters. The first is the Remote Display Offset. This gives you the ability to force the remote display to show different values than those sent to the PLC. The two additional parameters are Setup Parameters that you must program if you use the fiber optic communication link. These two parameters are Number of Splices and Fiber Optic Run Length. A module uses these parameters to set the power output of the fiber optic transmitter. If these two parameters are not programmed correctly, the fiber optic link may not operate. The modules also have one additional error message that is displayed if the remote display board inside the module is not communicating with the main board of the module.

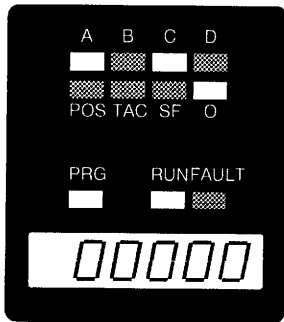

Fig A.4 Remote Display Offset

Remote Display Offset - This value is added to the position data before it is sent to the remote display. This offset does not affect the value displayed by the 7451-01 or sent to the programmable controller.

In this programming example, you change the Remote Display Offset from its default of 0 to 2000.

PRESS	IND. LEDS	DISPLAY	COMMENTS
*[FUNCTION]	O + A + C	" <u>00000</u> "	Default Value.
[▶] [▲]X2, [ENTER]	O + A + C	"02000"	Value stored in E ² PROM. Blinking Cursor removed.

Additional Displays and Keyboard Programming (cont'd)

Setup Parameters

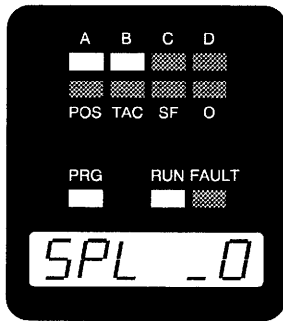

Number of Splices - Must be set to the number of splices in the fiber optic cable over the entire cable run. This parameter accepts values between 0 and 4. When this Parameter is changed, the Fiber Optic Cable length is reset to zero.

Fig A.5 # of Splices

In this programming example, you change the Number of Splices to 2 from its default of 0.

PRESS	IND. LEADS	DISPLAY	COMMENTS
*[FUNCTION]	A + B	"SPL _ <u>0</u> "	Default Value.
[▲]X2, [ENTER]	A + B	"SPL _2"	Value stored in E ² PROM. Blinking Cursor removed.

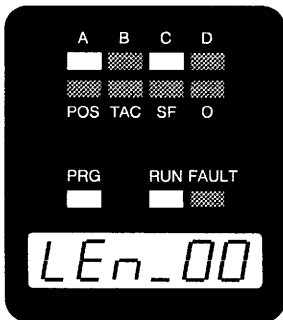

Fiber Optic Run Length - Must be set to the total length of cable between the 7451-01 module and the 6100F Remote Display. This parameter is programmed in meters and its maximum value depends on the number of splices. Refer to Figure A.2 Maximum Fiber Optic Cable Run Lengths, Pg A-2 for a list of maximum cable lengths. Programming a length of zero disables the fiber optic link.

Fig A.6 FO Run Length

In this programming example, you change the Length to 30 meters (100 feet) from its default of zero.

PRESS	IND. LEADS	DISPLAY	COMMENTS
*[FUNCTION]	A + C	"LEn _ <u>00</u> "	Default Value.
[▲]X3, [ENTER]	A + B	"LEn _30"	Value stored in E ² PROM. Blinking Cursor removed.

Additional Error Messages

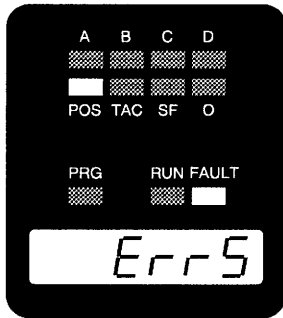

Fig A.7 RD Board Fault

Error Class 5:

Remote Display Board Fault. - Occurs when there is a communications fault between the remote display board inside the module and the modules' main board. If this error occurs, cycle power to the module. If the error message remains, the module must be returned for repairs. See inside front cover *Returns Policy*: for additional information.

Error Messages are transmitted to the 6100F and are shown on the its display. For a complete list of error messages that a 6100F displays, refer to the 6100F User's Manual.

Transducer Cable Changes

Because of the positioning of the RS-485 Input Connector on the modules' front panel, a MS-8 Connector cannot be used as the Transducer Connector. A MS-8W should be used. See Print B1194 For the proper cable drawing.

Data Format

When the processor accesses the registers assigned to the 7451-01, the module transmits four 16 bit words to the processor.

Bit Number	16	15	14	13	12	11	10	09	08	07	06	05	04	03	02	01
Word 1	0	15 Least Significant Bits: Position Data														
Word 2	0	0	0	0	0	0	U*	S*	0	0	0	0	0	0	P*	
Word 3	E*	0	0	0	15 Least Significant Bits: Velocity Data											
Word 4	0	0	0	0	0	0	0	S*	0	0	0	0	0	0	V*	

Notes:

- P*, V* These two bits are the most significant bits of the position or velocity data respectively. If your maximum position or velocity data is below 32767, these bits will always be zero.
- S* Sign Bit. Position data is transmitted is sign/magnitude format. This bit is set when the position data is negative.
- U* Underflow/Overflow Bit. This bit is set when the position or velocity data is outside of its $\pm 99,999$ count range. Use the sign bit to determine if the condition is an overflow or underflow. The position or velocity data shows the magnitude of the under/overflow.
- E* Error Bit. Set when any error is detected by the module. Position and velocity data transmitted to the controller is the last valid information before the error.

DATE	BY	REVISION RECORD	AUTH.	DR.	CK.
7/30	A	PIN DESIGNATIONS	SPS	JAM	

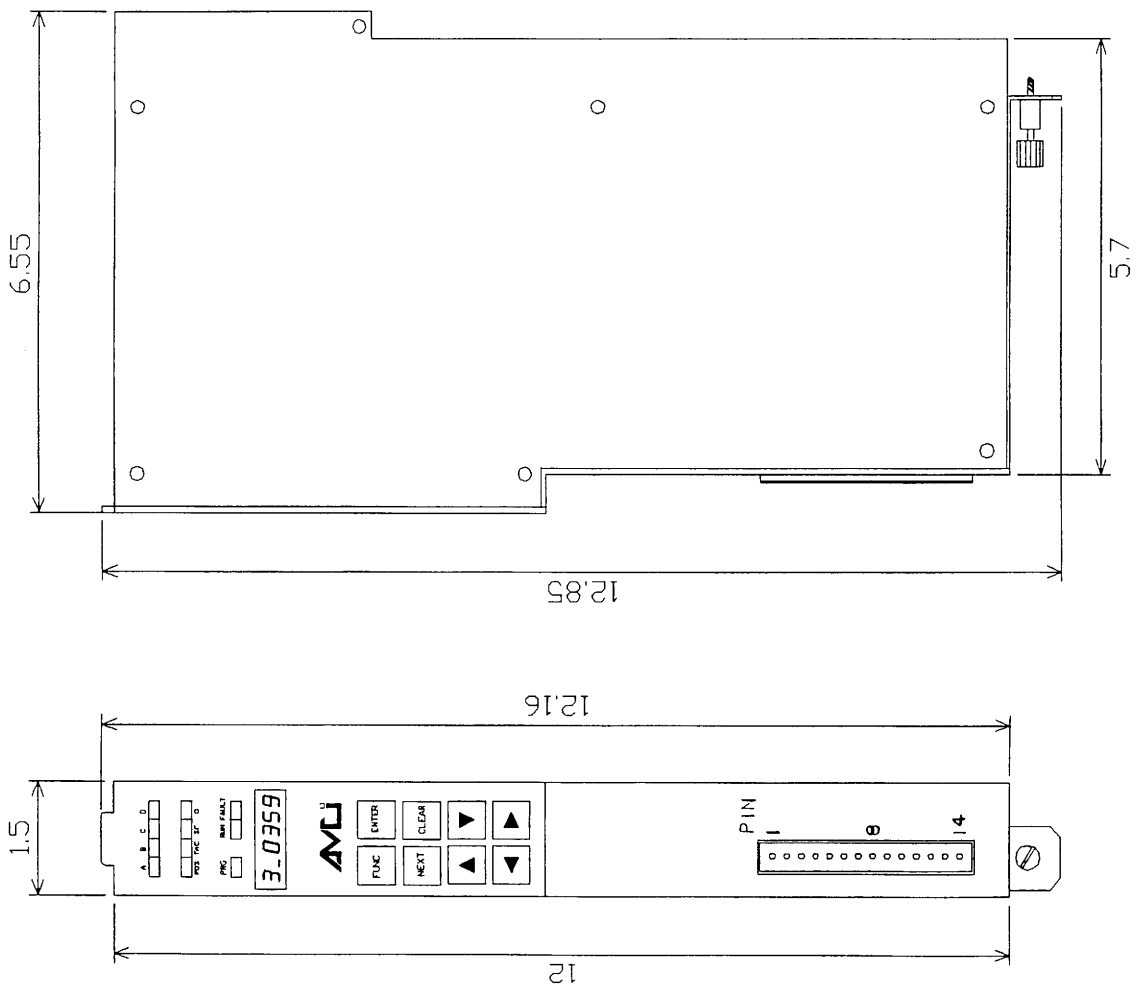

ADVANCED MICRO CONTROLS INC.	
TOLERANCES (EXCEPT AS NOTED)	SCALE
DECIMAL	NONE
FRACTIONAL	
ANGULAR	
DRAWN BY <i>JAM</i>	
APPROVED BY	
TITLE	
OUTLINE DRAWING	
DATE	DRAWING NUMBER
5/30/91	B1153 REV. A

MADE IN U.S.A.

K&E ALBANY # 10 5465 ENGINEERS' STANDARD FORM

DATE	SYM	REVISION RECORD	AUTH	DR	CK

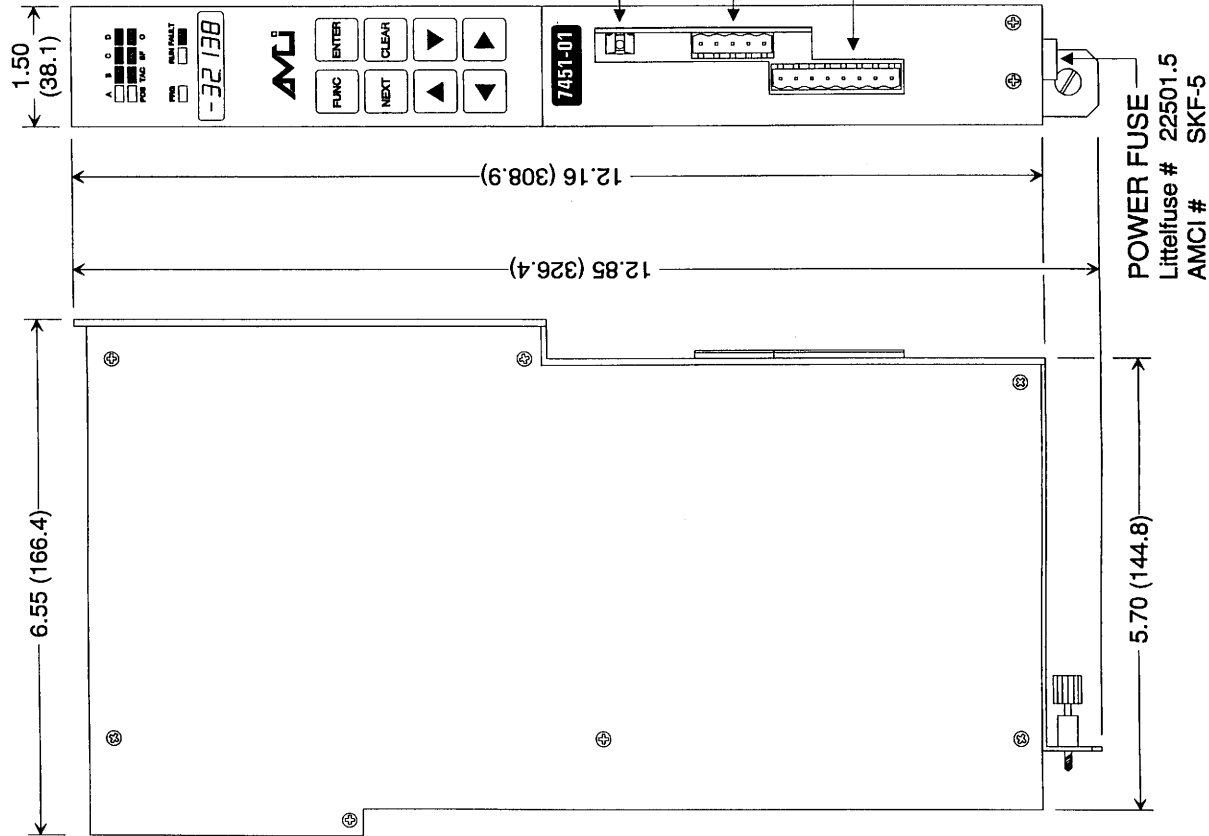

FIBER OPTIC TRANSMITTER - For use with 6100F Remote Displays.
Mates with Fiber Optic Cable AMCI # CDP-(x) where (x) is length in meters.

RS-485 CONNECTOR - For use with 6100F Remote Displays.
Mates with:
Phoenix #: MVSTBW 2.5/5-ST-5.08
AMCI #: MS-5W

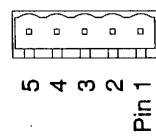

NOTE: + Vn is supplied by the 6100F Remote Display.
See Print A1083 for RS-485 Cable AMCI # CDC-(x) where (x) is length in meters.

TRANSUDUCER INPUT CONNECTOR
Mates with:
Phoenix #: MVSTBW2.5/8-5.08
AMCI #: MS-8W
See B1194 for Cable Pin-out.

POWER FUSE
Littelfuse # 22501.5
AMCI # SKF-5

TOLERANCES (EXCEPT AS NOTED)	AMCI ADVANCED MICRO CONTROLS INC.	
DECIMAL	SCALE	DRAWN BY
±	7451-01	DWN
FRACTIONAL	NONE	APPROVED BY
±		FR
ANGULAR	TITLE	DATE
±	Outline and Connector Pin-out	3/1/93
	DRAWING NUMBER	
	B1189	

DATE	SYM	REVISION RECORD	AUTH	DR	CK
3/83	A	Added MS Connector Part #'s.	DWN		

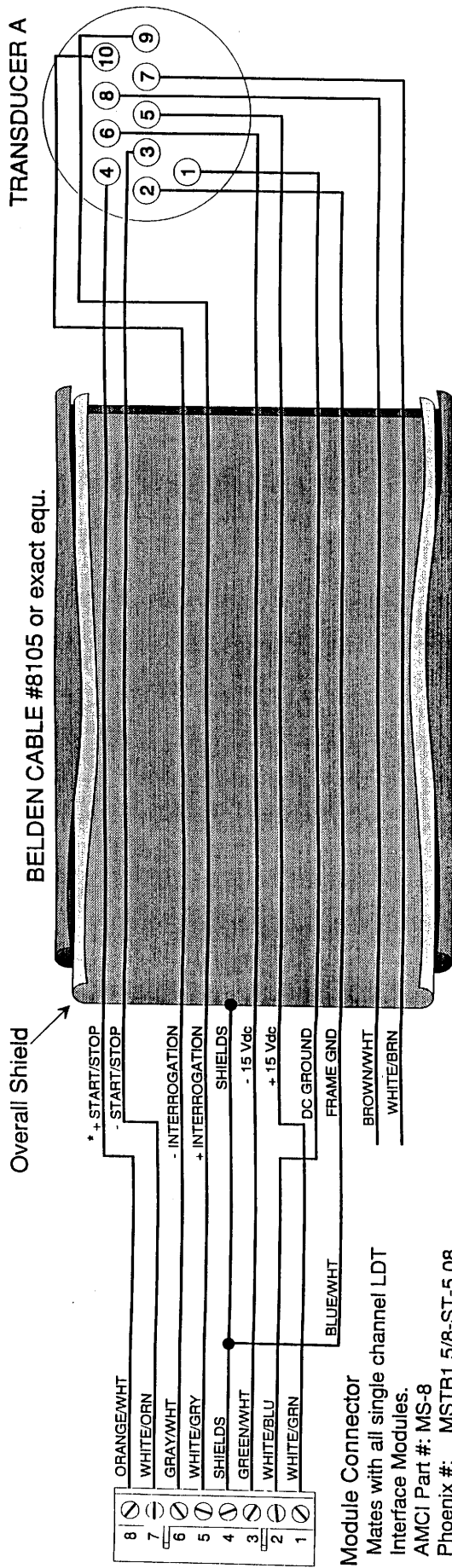

BELDEN CABLE #8105 or exact equ.

Overall Shield

TRANSUDCER A

8	ORANGE/WHT
7	WHITE/ORN
6	GRAY/WHT
5	WHITE/GRY
4	SHIELDS
3	GREEN/WHT
2	WHITE/BLU
1	WHITE/GRN

Module Connector
 Mates with all single channel LDT Interface Modules.
 AMC/ Part #: MS-8
 Phoenix #: MSTB1.5/8-ST-5.08

* Cable for Transducers with RPM Personality Module is shown.
 For Transducers with DPM Personality Module, the following pins are renamed:
 + Start/Stop renamed to + Gate Out
 - Start/Stop renamed to - Gate Out.

7400 AND 7900 USERS:
 Pin 1 of the Modules' Transducer Input Connector is located toward the top of the 74/7900 Module, Not the bottom as this drawing may imply. Reversing the wires from the LDT will not harm the 74/7900 Module, but it may damage the Personality Module in the LDT.
IF YOUR MODULE HAS THE REMOTE DISPLAY OPTION, the module connector must be an MS-8W. Refer to Print B1194.

TOLERANCES (EXCEPT AS NOTED)	AMC ADVANCED MICRO CONTROLS INC.	
DECIMAL	SCALE	DRAWN BY DWN
FRACTIONAL		APPROVED BY FR
ANGULAR	TITLE 1 CHANNEL WIRING DIAGRAM	
	DATE 7/15/92	DRAWING NUMBER B1178 REV. A

DATE	SYM	REVISION RECORD	AUTH	DR	CK

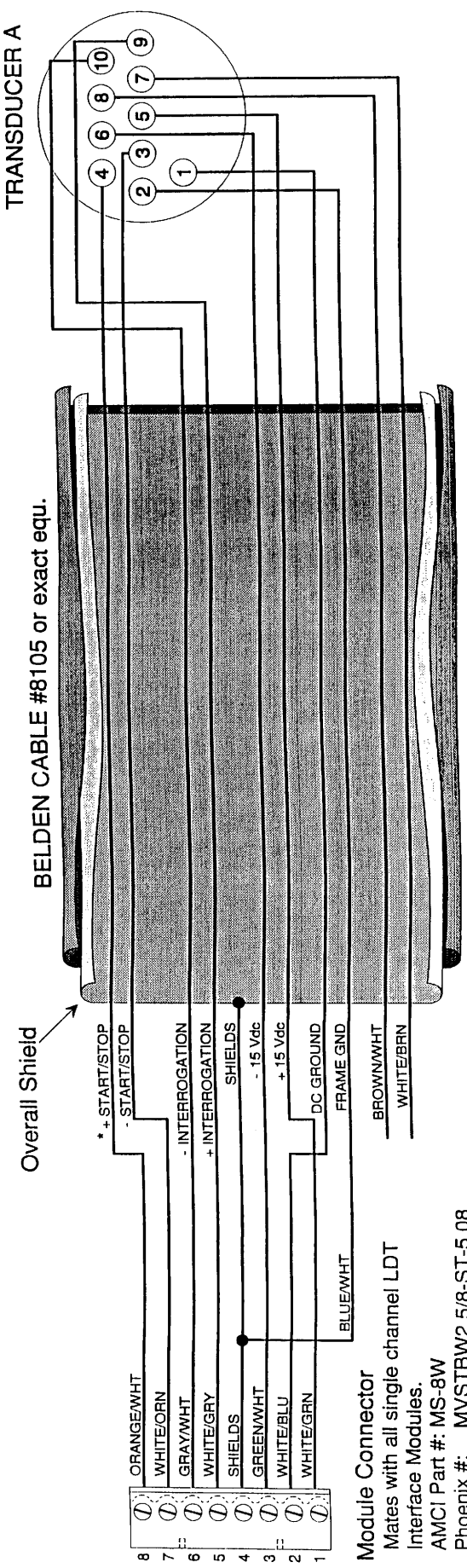

Module Connector
 Mates with all single channel LDT Interface Modules.
 AMCI Part #: MS-8W
 Phoenix #: MVSTBW2.5/8-ST-5.08

* Cable for Transducers with RPM Personality Module is shown.
 For Transducers with DPM Personality Module, the following pins are renamed:
 + Start/Stop renamed to + Gate Out
 - Start/Stop renamed to - Gate Out.

7400 AND 7900 USERS:
 Pin 1 of the Modules' Transducer Input Connector is located toward the top of the 747900 Module. Not the bottom as this drawing may imply. Reversing the wires from the LDT will not harm the 747900 Module, but it may damage the Personality Module in the LDT.

TOLERANCES (EXCEPT AS NOTED)	AMCI ADVANCED MICRO CONTROLS INC.	
DECIMAL	SCALE	DRAWN BY DWN
FRACTIONAL	APPROVED BY $\text{\textcircled{R}}$	
ANGULAR	TITLE	DRAWING NUMBER
	1 Channel Wiring Diagram w/ MS-8W	B1194
	DATE	
	3/8/93	

DATE	SYM	REVISION RECORD	AUTH.	DR.	CK.

7400 AND 7800 USERS:
 Pin 1 of the Transducer Input Connector is located toward the top of the 74/7800 Module, NOT the bottom as this drawing may imply. Reversing the wires from the LDT will not harm the 74/7800 Module, but it may damage the Personality Module in the LDT.

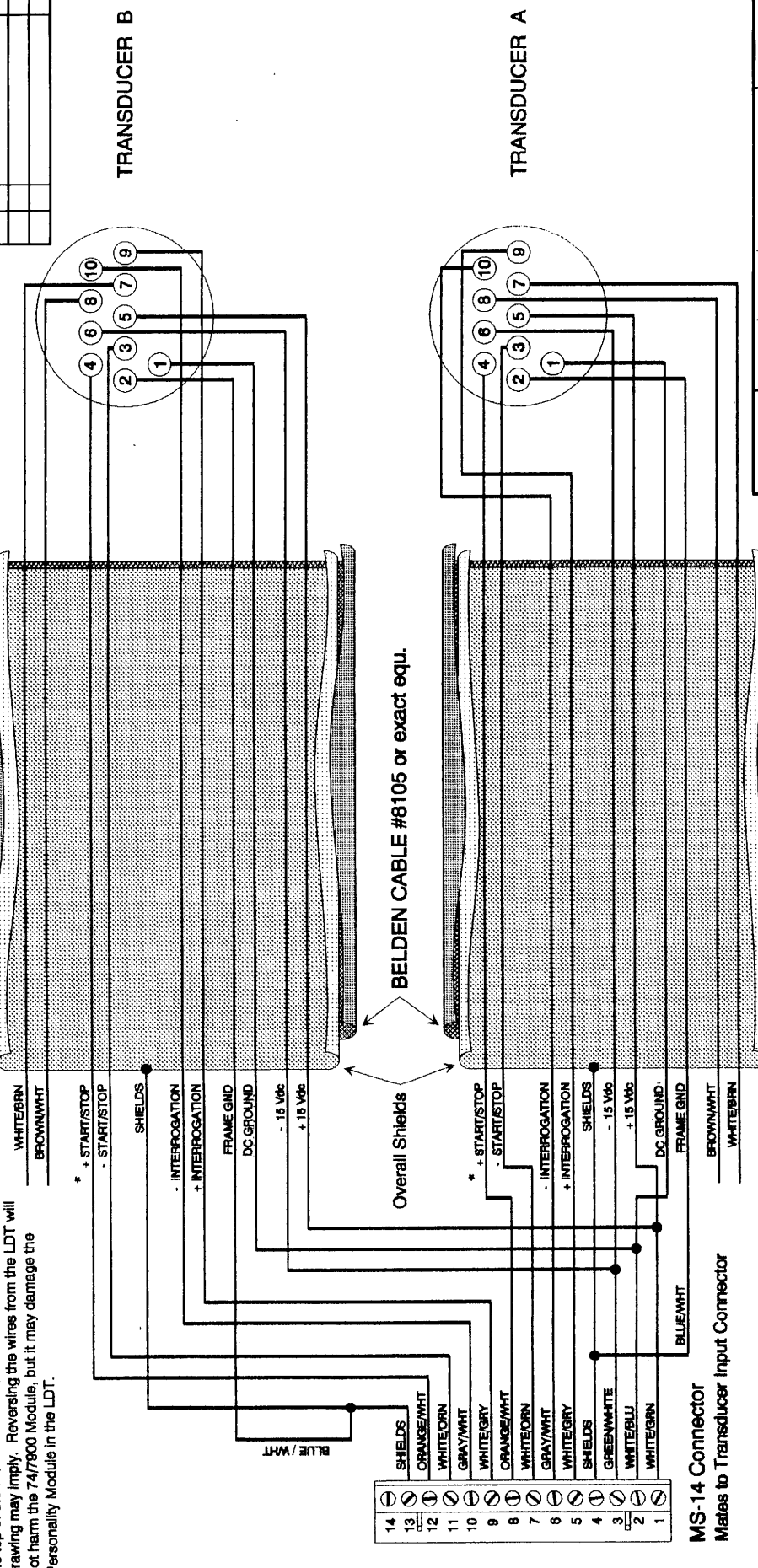

TRANSUDUCER B

TRANSUDUCER A

BELDEN CABLE #8105 or exact equ.

14	SHIELDS
13	ORANGE/WHT
12	WHITE/ORN
11	GRAY/WHT
10	WHITE/GRY
9	ORANGE/WHT
8	WHITE/ORN
7	GRAY/WHT
6	WHITE/GRY
5	SHIELDS
4	GREEN/WHTE
3	WHITE/BLU
2	WHITE/GRN
1	

MS-14 Connector
 Mates to Transducer Input Connector

* Cable for Transducers with RPM Personality Module is shown.
 For Transducers with DPM Personality Module, the following pins are renamed:
 + Start/Stop renamed to + Gate Out
 - Start/Stop renamed to - Gate Out.

ADVANCED MICRO CONTROLS INC.	
TOLERANCES (UNLESS NOTED)	SCALE
DECIMAL	NONE
FRACTIONAL	APPROVED BY <i>JRS</i>
ANGULAR	TITLE
±	2 AXIS WIRING DIAGRAM
DATE	DRAWING NUMBER
7/15/92	B1177



PLYMOUTH INDUSTRIAL PARK, TERRYVILLE, CT 06786
TEL. (203) 585-1254 FAX. (203) 584-1973