

SD31045E Stepper Motor Indexer/Driver

User Manual

AMCI Motion Control Products



GENERAL INFORMATION

Important User Information

The products and application data described in this manual are useful in a wide variety of different applications. Therefore, the user and others responsible for applying these products described herein are responsible for determining the acceptability for each application. While efforts have been made to provide accurate information within this manual, AMCI assumes no responsibility for the application or the completeness of the information contained herein.

UNDER NO CIRCUMSTANCES WILL ADVANCED MICRO CONTROLS, INC. BE RESPONSIBLE OR LIABLE FOR ANY DAMAGES OR LOSSES, INCLUDING INDIRECT OR CONSEQUENTIAL DAMAGES OR LOSSES, ARISING FROM THE USE OF ANY INFORMATION CONTAINED WITHIN THIS MANUAL, OR THE USE OF ANY PRODUCTS OR SERVICES REFERENCED HEREIN.

No patent liability is assumed by AMCI, with respect to use of information, circuits, equipment, or software described in this manual.

The information contained within this manual is subject to change without notice.

This manual is copyright 2013 by Advanced Micro Controls Inc. You may reproduce this manual, in whole or in part, for your personal use, provided that this copyright notice is included. You may distribute copies of this complete manual in electronic format provided that they are unaltered from the version posted by Advanced Micro Controls Inc. on our official website: www.amci.com. You may incorporate portions of this documents in other literature for your own personal use provided that you include the notice "Portions of this document copyright 2013 by Advanced Micro Controls Inc." You may not alter the contents of this document or charge a fee for reproducing or distributing it.

Standard Warranty

ADVANCED MICRO CONTROLS, INC. warrants that all equipment manufactured by it will be free from defects, under normal use, in materials and workmanship for a period of [18] months. Within this warranty period, AMCI shall, at its option, repair or replace, free of charge, any equipment covered by this warranty which is returned, shipping charges prepaid, within eighteen months from date of invoice, and which upon examination proves to be defective in material or workmanship and not caused by accident, misuse, neglect, alteration, improper installation or improper testing.

The provisions of the "STANDARD WARRANTY" are the sole obligations of AMCI and excludes all other warranties expressed or implied. In no event shall AMCI be liable for incidental or consequential damages or for delay in performance of this warranty.

Returns Policy

All equipment being returned to AMCI for repair or replacement, regardless of warranty status, must have a Return Merchandise Authorization number issued by AMCI. Call (860) 585-1254 with the model number and serial number (if applicable) along with a description of the problem during regular business hours, Monday through Friday, 8AM - 5PM Eastern. An "RMA" number will be issued. Equipment must be shipped to AMCI with transportation charges prepaid. Title and risk of loss or damage remains with the customer until shipment is received by AMCI.

24 Hour Technical Support Number

24 Hour technical support is available on this product. If you have internet access, start at www.amci.com. Product documentation and FAQ's are available on the site that answer most common questions.

If you require additional technical support, call (860) 583-7271. Your call will be answered by the factory during regular business hours, Monday through Friday, 8AM - 5PM Eastern. During non-business hours an automated system will ask you to enter the telephone number you can be reached at. Please remember to include your area code. The system will page an engineer on call. Please have your product model number and a description of the problem ready before you call.

We Want Your Feedback

Manuals at AMCI are constantly evolving entities. Your questions and comments on this manual are both welcomed and necessary if this manual is to be improved. Please direct all comments to: Technical Documentation, AMCI, 20 Gear Drive, Terryville CT 06786, or fax us at (860) 584-1973. You can also e-mail your questions and comments to techsupport@amci.com

TABLE OF CONTENTS

General Information

Important User Information	2
Standard Warranty	2
Returns Policy	2
24 Hour Technical Support Number	2
We Want Your Feedback	2

About this Manual

Audience	7
Applicable Units	7
Firmware 8.9 and above	7
Firmware 6.8-	7
Firmware 5.6-	7
D12100046 and below	8
D06100061 and below	8
Navigating this Manual	8
Manual Conventions	9
Trademark Notices	9
Revision Record	9
Revision History	9
Where To Go From Here	10

Chapter 1: Introduction to the SD31045E

The SD31045E	11
General Functionality	11
Encoder Functionality	12
Indexer Functionality	13
Driver Functionality	14
Ethernet Port	15
Network Status LED's	15
Specifications	16

Chapter 2: Motion Control

Motor Position	17
Motor Speed	17
Acceleration & Deceleration	17
Acceleration Jerk	18
Available Inputs	18
Home Input	18
CW Limit Switch or CCW Limit Switch	19
Start Indexer Move Input	19
Emergency Stop Input	19
Stop Manual or Registration Move Input	19

Chapter 2: Motion Control (continued)

Encoder Feedback	19
Capture Encoder Position Input	20
General Purpose Input	20
Defining Home Position	20
Position Preset Command	20
Find Home CW & Find Home CCW Commands	20
Manual Move	23
Controlled Stop Conditions	23
Immediate Stop Conditions	23
Registration Move	24
Controlled Stop Conditions	25
Immediate Stop Conditions	25
Relative Move	25
Controlled Stop Conditions	26
Immediate Stop Conditions	26
Absolute Move	26
Controlled Stop Conditions	27
Immediate Stop Conditions	27
Encoder Moves	27
Controlled Stop Conditions	27
Immediate Stop Conditions	28
Assembled Moves	28
Blend Moves	28
Controlled Stop Conditions	29
Immediate Stop Conditions	29
Dwell Move	30
Controlled Stop Conditions	30
Immediate Stop Conditions	30
Assembled Move Programming	31
Control Bits – Output Data	31
Control Bits – Input Data	31
Programming Routine	31
Indexed Moves	32
Controlling Moves In Progress	33
Find Home Moves	33
Manual Moves	33
Absolute, Relative and Encoder Moves	33
Assembled Moves	33

**Chapter 2: Motion Control
(continued)**

Electronic Gearing	34
Motor Steps/Turn	34
ELGearing Multiplier and Divisor	34
How It Works	34
Controlled Stop Conditions	34
Immediate Stop Conditions	34
Advanced Ratio Control	35
Stall Detection	35
Hybrid Control	35
Idle Current Reduction	36
Current Loop Gain	36

**Chapter 3: General Installation
Guidelines**

Grounding	39
Grounding Electrode System	39
Ground Bus	39
Grounding Electrode Conductor ...	40
Grounding Wires	40
Avoiding Grounding Problems	40
Surge (EMI) Suppression	41
Incoming Power	41
Inductive Loads	42
System Environment	42
System Layout Considerations	42
Wiring Categories for the SD31045E	42
Minimize Voltages in the System Enclosure	43
Power Supply Sizing	43
Component Placement	43
Conduits to Enclosure	44
Installing a SD31045E	44

Chapter 4: Installing the SD31045E

Outline Drawing	45
Mounting Methods	45
Airflow and Wiring Space	45
Grounding and Powering the System	46
Installing the Stepper Motor	47
Outline Drawings	47
Mounting the Motor	47
Connecting the Load	47
Extending the Motor Cable	47
Installing the Motor Cable	47

Chapter 4: Installing the SD31045E

Connecting the Motor	48
Motor Connector	48
Interlock Wiring	48
Using the Interlock for Emergency Stops	48
Motor Wiring	49
I/O Wiring	50
Input Wiring	50
Output Wiring	51
Encoder Wiring	51
Ethernet Connection	52
Network Status LED's	52

Chapter 5: Network Configuration

Factory Default	53
Assumptions	53
Firewalls	53
Installing the AMCI NET Software	53
Configure Your Network Interface Card (NIC)	54
Attach the SD31045E	55
Using the AMCI Net Configurator	55
Start the Software	55
Connect to your SD31045E	56
The Meaning of the Product Name	57
Changing the IP Address	57
Setting Communications Protocol	57
Cycle Power to the SD31045E	57
Testing the New Address	57
SD31045E Tab	58
Using the Ping Command	59

**Chapter 6: EtherNet/IP
Configuration**

RSLogix 5000 Configuration	61
Configure Bridge Module (As Needed)	61
Configuring a Built-in Ethernet Port (As Needed)	62
Adding the SD31045E	62
Error Code 16#0109 63	
RSLogix 500 Configuration	63
Using Message Instructions in a MicroLogix 1100 PLC	63
Troubleshooting	67

TABLE OF CONTENTS

Chapter 7: Modbus/TCP Configuration

SD31045E Memory Layout	69
Supported Modbus Functions	70
Supported Modbus Exceptions	70

Chapter 8: Configuration Mode Data Format

Modes of Operation	71
Configuration Mode	71
Command Mode	71
Multi-Word Format	71
Output Data Format	72
Control Word Format	72
Configuration Word Format	74
Notes on Other Configuration Words	75
Input Data Format	76
Control Word Format (Word 0)	76
Invalid Configurations	76

Chapter 9: Command Mode Data Format

Multi-Word Format	77
Command Bits Must Transition	77
Output Data Format	77
Command Bits MSW	78
Command Bits LSW	79
Description of Motor Current Keys	80
Command Blocks	81
Absolute Move	81
Relative Move	81
Hold Move	82
Resume Move	82
Immediate Stop	83
+Find Home (CW)	83
-Find Home (CCW)	84
+Manual Move (CW)	84
+Registration Move (CW)	85
-Manual Move (CCW)	85
-Registration Move (CCW)	86
Encoder Follower Move	86
Preset Position	87
Reset Errors	87
Run Assembled Move	88
Preset Encoder Position	88

Chapter 9: Command Mode Data Format

Programming Blocks	89
First Block	89
Segment Block	89
Input Data Format	90
Status Word 1 Format	90
Status Word 2 Format	92
Motor Position Data	93
Encoder Position Data	93
Captured Encoder Position Data ...	93
Notes on Clearing a Driver Fault	94
Reset Driver Fault	94

Chapter A: IP Address Setup With BootP

Initial Configuration	95
Using the RA BOOTP Server	95
Attach the SD31045E	95
Start Your Bootp Server	95
Enabling Bootp Protocol	96
Setting the IP Address	97
Disabling the Bootp Protocol	98
Testing the New IP Address	98

Chapter B: UL/CUL Recognized Installations

UL Required Information	99
-------------------------------	----

Notes

ABOUT THIS MANUAL

Read this chapter to learn how to navigate through this manual and familiarize yourself with the conventions used in it. The last section of this chapter highlights the manual's remaining chapters and their target audience.

Audience

This manual explains the set-up, installation, and operation of AMCI's SD31045E Stepper Motor Indexer / Driver. It is written for the engineer responsible for incorporating the SD31045E into a design, as well as the engineer or technician responsible for its actual installation.

Applicable Units

Most of this manual applies to all SD31045E indexer/driver units, but some of the features explained in this manual are only available with later firmware revisions.

- Starting with firmware revision 5.6, the firmware revision was printed on the serial number tag. If you don't see a firmware revision number on the tag, then you have an older unit.
- The serial number is also a date code, so you can determine when the unit was released by reviewing the serial number itself.

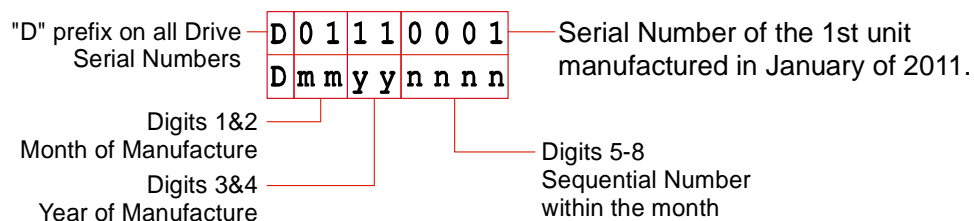

Firmware 8.9 and above

Units with firmware 8.9 and above, (Serial number D04120070 and above), have all of the features listed in this manual

Firmware 6.8-

Units with firmwares of 6.8 and below, (Serial number below D04120069), do not have the following features:

- Store Configuration parameters to Flash memory
- Store Blend Move parameters to Flash memory
- Heartbeat bit in Network Input Data
- In firmware 8.9 and above, the Drive Enable bit in Configuration Mode is ignored. You should enable and disable the drive while in Command Mode. For firmware 6.8 and below, the Drive Enable bit in Configuration Mode must be used to enable the driver.

Firmware 5.6-

In addition to any feature listed above, units with firmware 5.6 and below, (Serial number below D03110045) do not have the following additional features:

- Modbus/TCP communications protocol
- Indexed Move
- Hybrid Control
- IP Address cannot be configured with the Ethernet Configurator software from AMCI. You must use a Bootp server, such as the one supplied by Rockwell Automation.

Applicable Units (continued)

D12100046 and below

In addition to any feature listed above, units released prior to January of 2011 do not have the following features:

- Registration Moves
- Dwell Moves
- Indexed Move Type

D06100061 and below

In addition to any feature listed above, units released prior to July of 2010 do not have the following features:

- Interlock terminal cannot be used as a external way of disabling motor current.
- A Driver Fault (Interlock open, motor short, over temperature), cannot be reset via a network command.

Navigating this Manual

This manual is designed to be used in both printed and on-line formats. Its on-line form is a PDF document, which requires Adobe Acrobat Reader version 6.0+ to open it. The manual is laid out with an even number of pages in each chapter. This makes it easier to print a chapter to a duplex (double sided) printer.

Bookmarks of all the chapter names, section headings, and sub-headings were created in the PDF file to help navigate it. The bookmarks should have appeared when you opened the file. If they didn't, press the F5 key on Windows platforms to bring them up.

Throughout this manual you will also find *blue text that functions as a hyperlink* in HTML documents. Clicking on the text will immediately jump you to the referenced section of the manual. If you are reading a printed manual, most links include page numbers.

The PDF file is password protected to prevent changes to the document. You are allowed to select and copy sections for use in other documents and, if you own Adobe Acrobat version 6.0 or later, you are allowed to add notes and annotations.

ABOUT THIS MANUAL

Manual Conventions

Three icons are used to highlight important information in the manual:



NOTES highlight important concepts, decisions you must make, or the implications of those decisions.



CAUTIONS tell you when equipment may be damaged if the procedure is not followed properly.



WARNINGS tell you when people may be hurt or equipment may be damaged if the procedure is not followed properly.

The following table shows the text formatting conventions:

Format	Description
Normal Font	Font used throughout this manual.
<i>Emphasis Font</i>	Font used the first time a new term is introduced.
<i>Cross Reference</i>	When viewing the PDF version of the manual, clicking on the cross reference text jumps you to referenced section.

Trademark Notices

The AMCI logo is a trademark of Advanced Micro Controls Inc.

All other trademarks contained herein are the property of their respective holders.

Revision Record

This manual, 940-0S103, is the fourth revision of this manual. It adds additional information specified by an update to the product's UL file E231137 as well as saving configuration and blend move data to Flash and the heartbeat bit in the Network Input Data. It was first released April 12th, 2013.

Revision History

940-0S102 Added Hybrid Control and Modbus/TCP protocol.

940-0S101 Adds Registration Move, Dwell Move, and Indexed Move Type.

940-0S100 Initial Release.

Where To Go From Here

This manual contains information that is of interest to everyone from engineers to operators. The table below gives a brief description of each chapter's contents to help you find the information you need to do your job.

CHP Num.	Chapter Title	Intended Audience
1	<i>INTRODUCTION TO THE SD31045E</i>	Anyone new to the SD31045E. This chapter gives a basic overview of the features available on the unit, typical applications, and electrical specifications.
2	<i>MOTION CONTROL</i>	Anyone that needs detailed information on how the driver can be used to control motion in your application.
3	<i>GENERAL INSTALLATION GUIDELINES</i>	Anyone new to installing electronic controls in an industrial environment. The chapter includes general information on grounding, wiring, and surge suppression that is applicable to any controls installation.
4	<i>INSTALLING THE SD31045E</i>	Anyone that must install an SD31045E on a machine. Includes information on mounting, grounding, and wiring specific to the unit.
5	<i>NETWORK CONFIGURATION</i>	Anyone that must set the IP address and or communications protocol of the SD31045E using the AMCI Ethernet Configurator utility program.
6	<i>EtherNet/IP CONFIGURATION</i>	Anyone that needs information on configuring an Ethernet/IP host controller. Detailed instructions are given for ControlLogix, CompactLogix, and MicroLogix systems from Rockwell Automation.
7	<i>Modbus/TCP CONFIGURATION</i>	Anyone that needs information on configuring a Modbus/TCP host controller.
7	<i>CONFIGURATION MODE DATA FORMAT</i>	Anyone that needs detailed information on the format of the network data to and from the SD31045E used to configure the indexer/driver.
8	<i>COMMAND MODE DATA FORMAT</i>	Anyone that needs detailed information on the format of the network data to and from the SD31045E used to command the indexer/driver.
A	<i>IP ADDRESS SETUP WITH BOOTP</i>	Anyone that must set the IP address of the SD31045E using a BOOTP server.

INTRODUCTION TO THE SD31045E

This manual is designed to get you up and running quickly using the SD31045E stepper driver. As such, it assumes you have some basic knowledge of stepper systems, such as the resolution you want run your motor at, and the reasons why you'd want to use Idle Current Reduction and the reasons why you wouldn't. If these terms or ideas are new to you, we're here to help. AMCI has a great deal of information on our website and we are adding more all the time. If you can't find what you're looking for at <http://www.amci.com>, send us an e-mail or call us. We're here to support you with all of our knowledge and experience.

The SD31045E

General Functionality

The SD31045E is a 4.4Arms micro-stepping driver with a 310Vdc internal bus voltage. What makes the SD31045E unique is its built-in indexer that accepts configuration and command data from a host system over the internal Ethernet port. The SD31045E can be configured to use either the Ethernet/IP protocol, or the Modbus/TCP protocol, which makes the SD31045E easy to integrate into a wide variety of controller systems. This combination of host and driver gives you several advantages:

- Sophisticated I/O processing can be performed in the host (PLC or other controller) before sending commands to the SD31045E
- All motion logic is programmed in the host, eliminating the need to learn a separate motion control language
- Eliminating the separate indexer lowers Total System Cost

The SD31045E is powered by a nominal 230Vac 50/60Hz source. The SD31045E can also be powered by a 115Vac source and it will have a 170Vdc motor bus at this input voltage. The output motor current is fully programmable from 1.0Arms to 4.4Arms which makes the SD31045E compatible with AMCI's complete line of size 23 through size 42 stepper motors. It's even possible to change the motor current setting while the move is in progress. In addition to the Motor Current setting, the Motor Steps per Turn, Idle Current Reduction, and Anti-Resonance Circuit features are also fully programmable. If you have used other stepper indexer products from AMCI you will find programming to be very similar to these products.

The SD31045E is a true RMS motor current control driver. This means that you will always receive the motor's rated torque regardless of the *Motor Steps/Turn* setting. (Drivers that control the peak current to the motor experience a 30% decrease in motor torque when microstepping a motor.) The SD31045E automatically switches from RMS to peak current control when the motor is idle to prevent overheating the motor.

In addition to power and motor hookups, the SD31045E has three DC inputs and one DC output that are used by the indexer. Configuration data from the host sets the function of these points. The output can be configured to be a Fault Output or a general purpose output. Each input can be individually configured as a:

- CW or CCW Limit Switch
- Home Limit Switch
- Capture Encoder Position Input
- Stop Manual or Registration Move Input
- Start Indexer Move
- Emergency Stop Input
- General Purpose Input





The SD31045E (continued)

Encoder Functionality

In addition to the functions listed on the previous page, Inputs 1 and 2 can be programmed to accept the $\pm A$ and $\pm B$ signals from a quadrature encoder. When using an encoder, you have two additional choices when configuring Input 3. First, the $\pm Z$ signal can be wired to Input 3 and used to home the machine. Second, Input 3 can be used to capture the encoder position when it is programmed as a Capture Encoder Position Input or a Manual Move Stop Input.

Using an encoder input also gives you the ability to:

- Home the machine to the encoder marker pulse
- Make absolute and relative moves based on the encoder count instead of the stepper pulse count.
- Detect motor stall conditions.

An encoder input also allows you to drive the motor through a feature called *Electronic Gearing*. In this mode, the stepper motor follows the rotation of an external encoder. This encoder is typically attached to another motor. The ratio of encoder pulses to stepper pulses is programmable over a wide range. This mode electronically couples the two motors together through a programmable gear ratio.

Finally, revision 6.8 of the SD31045E added a feature called *Hybrid Control*. When enabled, this feature gives you servo-like performance without the need to tune servo PID loop parameters. When Hybrid Control is enabled, the SD31045E uses a motor mounted encoder to feed rotor position information back to the driver. The SD31045E uses this information during a move to dynamically increase or decrease the current through the motor's windings to the lowest values needed to achieve motion. This feature eliminates the possibility of resonance related motor stalls and can dramatically lower the motor's operating temperature, which prolongs the life of the motor.

When using this feature, a stepper motor will act in a manner very similar to a servo motor. This includes the possibility of a one count dither in position at zero speed. In order to overcome this condition, the SD31045E allows you to enable and disable the Hybrid Control feature on the fly. When the motor is at rest, a single message disables the Hybrid Control feature, and the motor acts as a stepper system, holding its position without dither. You can enable the Hybrid Control feature using the same message that initiates a move, minimizing the amount of motor current needed to complete the move.



Indexer Functionality

The table below lists the functionality offered by the indexer built into the SD31045E

Feature	Description
Multiple Ethernet Protocols	Each SD31045E can be configured to communicate with either EtherNet/IP or Modbus/TCP protocols. This allows easy setup and communication with a wide range of host controllers. Units ship with EtherNet/IP as the default protocol. The protocol can be easily switched by using a free utility from AMCI that can also be used to set the IP address information for the driver.
Programmable Inputs	Each of the three inputs can be programmed as a Home Limit, Over Travel Limit, Capture Input, Manual Jog Stop, or E-Stop Input. They can also be programmed to accept a quadrature encoder.
Programmable Output	The single output on the SD31045E can be programmed as a Fault Output or as a general purpose DC output point.
Programmable Parameters	Starting Speed, Running Speed, Acceleration, Deceleration, and Accel/Decel Types are fully programmable.
Homing	Allows you to set the machine to a known position. The SD31045E can home to a discrete input or to an encoder marker pulse.
Manual Move	Allows you to jog the motor in either direction based on an input bit from your controller.
Registration Move	Allows you to jog the motor in either direction based on an input bit from your controller. When a controlled stop is issued, the move will output a programmable number of steps before coming to a stop.
Relative Move	Allows you to drive the motor a specific number of steps in either direction from the current location.
Absolute Move	Allows you to drive the motor from one known location to another known location.
Blend Move	Allows you to perform a sequence of relative moves. These moves can be performed with or without stopping between them.
Indexer Move	Allows you to program a move that is held in memory. The move is run when one of the programmable inputs makes a transition.
Hold Move	Allows you to suspend a move and restart it without losing your position value.
Resume Move	Allows you to restart a previously held move operation.
Immediate Stop	Allows you to immediately stop all motion if an error condition is detected by your host controller.
Stall Detection	When the SD31045E is configured to accept an encoder, the encoder can be used to verify motion when a move command is issued.
Electronic Gearing	The SD31045E can be configured to control the position of a motor based on feedback from an external encoder. The ratio of encoder pulses to motor pulses is full programmable and can be changed on-the-fly.
Hybrid Control	The SD31045E can be configured to use a motor mounted encoder for rotor position feedback and use this data to dynamically alter motor current to the minimum value needed to achieve motion. This operating mode eliminates the possibility of resonance induced motor stalls and can significantly reduce the operating temperature of the motor.

Table 1.1 Indexer Functionality



Driver Functionality

This table summarizes the features of the stepper motor driver portion of the SD31045E.

Feature	Benefits
310Vdc Output Bus	A high voltage output bus means you can derive more high speed torque (power) from your stepper motor.
RMS Current Control	RMS current control give the SD31045E the ability to drive the motor at its fully rated power when microstepping. Peak current controllers typically experience a 30% drop in power when microstepping a motor.
Programmable Motor Current	RMS current supplied to the motor can be programmed from 1.0 to 4.4 amps in 0.2 amp increments. This allows you to use the driver with the full line of AMCI stepper motors.
Programmable Idle Current Reduction	Extends motor life by reducing the motor current when not running. This extends the life of the motor by reducing its operating temperature.
Programmable Current Loop Gain	Allows you to tailor the driver circuitry to the motor's impedances, thereby maximizing your motor's performance.
Programmable Motor Steps/Turn	Allows you to scale your motor count to a real world value. (counts per inch, counts per degree, etc.)
Anti-Resonance Circuitry	This circuitry gives the SD31045E the ability to modify motor current waveforms to compensate for mechanical resonance in your system. This will give you smooth performance over the entire speed range of the motor.
Motor Interlock	Safety feature that prevents power from being applied to the motor connector if a wire jumper does not exist between two of its pins. Starting with units manufactured in July of 2010, the Interlock has been re-designed to allow you to use it with a <i>mechanical contact</i> to disable the current to the motor. The voltage between the two interlock pins never exceeds 5Vdc, but 115Vac to 230Vac may be present between either of the Interlock pins and either of the power supply inputs.
Wiring Short Detection	Safety feature that removes power from the motor if a short is detected in one of the windings of the motor.
Over Temperature Detection	Protects the SD31045E from damage by removing power from the motor if the internal temperature of the driver exceed a safe operating threshold.

Table 1.2 Driver Functionality

Ethernet Port

The Ethernet Port is located on the top of the SD31045E. The connector is a standard RJ-45 jack that will accept any standard 100baseT cable. The Ethernet port on the SD31045E has “auto switch” capability. This means that a standard cable can be used when connecting the SD31045E to any device.

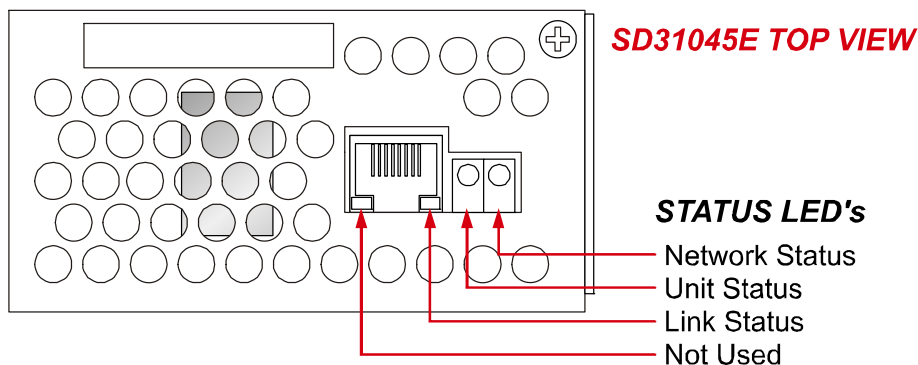

Figure 1.1 Ethernet Port Location

Network Status LED's

The status LED's indicate the health of the network connection between the SD31045E and its host. The Status LED on the front of the unit indicates the state of the SD31045E itself. The meaning of the Network Status LED depends on the protocol the SD31045E is configured to use.

- **Network Status (EtherNet/IP)** – Indicates the status of the connection between the SD31045E and its host. This LED will briefly flash red on power up while the SD31045E is initializing. It will flash green when the SD31045E has an IP address but valid configuration data has not yet been written to the driver. It is on steady green when a connection is established and valid configuration data has been written to the SD31045E. It will be on steady red if there is an IP address conflict or flash red if an established network connection is lost.
- **Network Status (Modbus/TCP)** – Indicates the number of TCP connections to the SD31045E. This LED will briefly flash red-green on power up while the SD31045E is initializing. It will flash green when a TCP connection is made to the driver. The number of flashes indicates the number of active connections. The SD31045E supports a maximum of three concurrent connections. There is a two second pause between flashes to make it easy to count the number of connections. This LED will flash red if an established TCP connection is lost.
- **Unit Status** – Indicates the status of the connection between the SD31045E and its Ethernet daughter board. This LED will briefly flash red on power up while the SD31045E is initializing. It will be green and on steady when the Ethernet daughter board and the rest of the SD31045E are communicating correctly.
- **Link Status** – On when there is a physical link between the Ethernet port of the SD31045E and the Ethernet port of the device the SD31045E is plugged into. This LED will flash when data is being transmitted over the Ethernet link.



Specifications

Driver Type

Two bipolar MOSFET H-bridges with a maximum output bus voltage of 310Vdc. 20KHz PWM current control.

Physical Dimensions

Width: 2.7 inches max.
Depth: 4.0 inches max.
Height: 6.2 inches
7.0 inches with mounting tabs

Weight

2.4 lbs. (1.1 kg.)

Inputs

Electrical Characteristics for all Inputs:
Differential. 1500 Vac/dc opto-isolated. Can be wired as single ended inputs.
Accepts 3.5 to 27Vdc without the need for an external current limiting resistor.

Output

Electrical Characteristics:
Open Collector/Emitter. 1500 Vac/dc opto-isolated. 30Vdc, 20 mA max.
The Output can be programmed to be a general purpose output or a Fault Output.
The Fault Output is normally on. Turns off under the following conditions:
Reset The driver initialization is not yet complete on power up.
Short Circuit Motor Phase to Phase or Phase to Earth Ground
Over Temp Heat Sink temperature exceeds 90° C (195° F)
No Motor The motor interlock terminals are not connected.
Faults are reported in the Network Input Data and can be cleared through the Network Output Data.

Motor Interlock

Two pins that must be shorted together before power is applied to motor. Can be shorted together through mechanical relay contacts.

Motor Current

Programmable from 1.0 to 4.4Arms in 0.2 Amp steps.

Resolution

Programmable to any value from 200 to 32,767 steps per revolution.

Idle Current Reduction

Programmable from 0% to 100% programmed motor current in 1% increments. Motor current is reduced to selected level if there is no motion for 1.5 seconds. Current is restored to full value when motion is started.

Internal Power Fuses

10 Amp Slow Blow. Both Line and Neutral are fused. Fuses are not user replaceable.

Environmental Specifications

Input Power 95 to 264Vac, 50/60 Hz, 5.0 Apk max.
Ambient Operating Temperature
..... -4° to +122°F (-20° to +50°C)
Storage Temperature
..... -40° to +185°F (-40° to +85°C)
Humidity 0 to 95%, non-condensing

Motor Specifications

Type 2 phase hybrid. 4, 6, or 8 lead motor
Insulation Minimum 500Vdc phase-to-phase and phase-to-case
Inductance 0.3 mH minimum. 2.5 to 45 mH recommended

Status LED

Steady Green Driver OK
Solid Red Short Circuit Fault
Over Temp Fault
Interlock Missing

The SD31045E will only detect motor errors when the motor current is enabled.

Connectors

All mating connectors are included with driver.

Connector	Wire	Strip Length	Min./Max. Tightening Torque
I/O	28 - 16 AWG	0.275 inches	1.91/2.23 lb-in (0.22/0.25 Nm)
Motor	24 - 12 AWG	0.275 inches	4.46/5.35 lb-in (0.5/0.6 Nm)
Power	24 - 12 AWG	0.275 inches	4.46/5.35 lb-in (0.5/0.6 Nm)

CHAPTER 2

MOTION CONTROL

The function of the SD31045E is to control the position and speed of a stepper motor. This chapter outlines the parameters used by the SD31045E to achieve this control and the types of moves available. Once you are done with this chapter you will have a solid understanding of how the SD31045E operates.

Motor Position

Commutators are used in motor designs to switch current to the windings of the motor to achieve rotation. Stepper motors do not have commutators. Instead, the windings of the motor are brought out and attached to a stepper driver such as the SD31045E. The SD31045E directly controls the current through each winding to achieve motion. This gives the SD31045E the ability to control not only the speed the motor rotates at, but also the position that the motor stops at. Therefore we can talk about the position of the motor (angle of the shaft) and moving the motor from one position to another (rotating the shaft n degrees). This is open loop positioning control.

NOTE  This manual assumes that you, the reader, know how a stepper motor works. If you don't know, or need a refresher, further information on stepper motors can be found in the *Tech Tutorial* section of our website at <http://www.amci.com/tech-tutorials.asp>.

The number of steps required to achieve one complete rotation of the motor shaft is fully programmable on the SD31045E. This parameter is called *Motor Steps/Turn* and can be programmed to any value between 200 and 32,767 and does not have to be equal to the steps/turn printed on the motor's label.

Motor Speed

The rotational speed of the motor shaft is controlled by the SD31045E by controlling how fast the currents through the windings change. The speed of the shaft is determined by a parameter called *Programmed Speed* and the units of this parameter is steps per second.

The Motor Steps/Turn parameter has an effect on the actual rotational speed of the shaft. If you program the Motor Steps/Turn to 500 and perform a move with a Programmed Speed of 5,000 steps per second, the shaft will rotate at $5,000/500 = 10$ revolutions per second while running at the programmed speed.

In addition to the Programmed Speed parameter, there is a *Starting Speed* parameter that is also defined in terms of steps/sec. The Starting Speed is the speed at which all moves begin and end. A low Starting Speed is needed to prevent the motor from stalling when moving a large inertial load. A higher starting speed can be used on small inertial loads to minimize the time required to accelerate to the Programmed Speed.

The Starting Speed parameter has a range of 1 to 1,999,999 steps/sec.

Acceleration & Deceleration

Like all motor systems, a stepper motor must usually accelerate to its Programmed Speed and decelerate before coming to a complete stop. The rates of acceleration and deceleration are completely programmable on the SD31045E as well as the type of acceleration used.

Accelerations and decelerations are programmed in units of steps per millisecond per second (steps/ms/sec) and have a range of 1 to 5000. When evaluating the acceleration and deceleration values of your move you will most likely determine them in terms of revolutions/sec². To convert to steps/ms/sec, multiply your revolutions/sec² value by the value of the Motor Steps/Turn parameter and divide by 1,000.



Acceleration & Deceleration (continued)

Acceleration Jerk

The *Jerk* parameter controls the type of acceleration used by the SD31045E during the move.

When $Jerk = 0$, Constant acceleration is used. The driver will accelerate the motor at a constant rate until the programmed speed is reached. This type of acceleration will reach the programmed speed the fastest, but changes in acceleration at the beginning and ending of the acceleration period are abrupt. This may cause problems in systems with large inertial loads.

Constant Acceleration

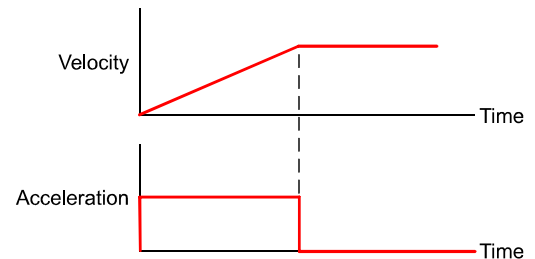

Figure 2.1 Constant Acceleration

When $Jerk = 1$, Triangular S Curve acceleration is used. The driver will accelerate the motor at a constantly changing rate until the programmed speed is reached. This type of acceleration will be the slowest in reaching the programmed speed, but it offers the smoothest acceleration.

Triangular S Curve Acceleration

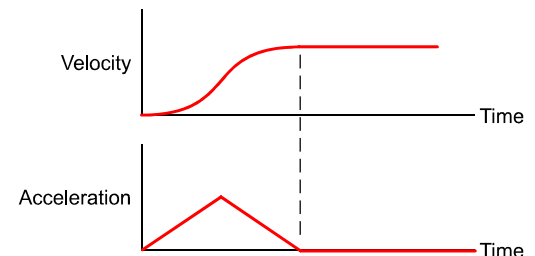

Figure 2.2 Triangular S Curve Acceleration

When the Jerk parameter is programmed in the range of 2 to 5000, Trapezoidal S Curve acceleration is used. In this acceleration type, the acceleration changes smoothly at the beginning and the ending, and accelerates linearly during the mid portion of the acceleration time. The value of the Jerk parameter sets the time of linear acceleration, with larger values setting a longer linear acceleration period. This acceleration type offers a good compromise between the smoothness of acceleration and the time it takes to reach the programmed speed.

Trapezoidal S Curve Acceleration

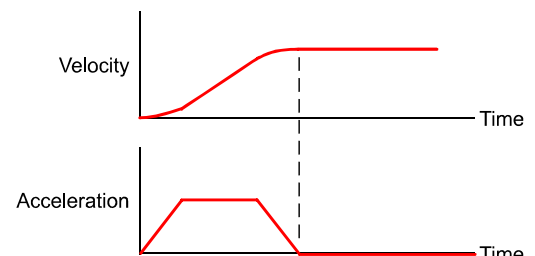

Figure 2.3 Trapezoidal S Curve Acceleration

Available Inputs

The SD31045E has three DC inputs that accept 3.5 to 27Vdc signals. (5 to 24Vdc nominal) They can be wired as differential, sinking, or sourcing inputs. How the SD31045E uses these inputs is fully programmable as well as their active states. (Normally Open (NO) or Normally Closed (NC) inputs.)

Home Input

Many applications require that the machine be brought to a known position before normal operation can begin. This is commonly called “homing” the machine or bringing the machine to its “home” position. The SD31045E allows you to define this starting position in two ways. The first is with a Position Preset Command. The second is with a sensor mounted on the machine. When you define one of the inputs as the Home Input, you can issue commands to the SD31045E that will cause the unit to seek this sensor. How the SD31045E actually finds the Home sensor is described in the [Defining Home Position](#) section starting on page 20.

Available Inputs (continued)

CW Limit Switch or CCW Limit Switch

Each input can be defined as a CW or CCW Limit Switch. When used this way, the inputs are used to define the limits of mechanical travel. For example, if you are moving in a clockwise direction and the CW Limit Switch activates, all motion will immediately stop. At this point, you will only be able to move in the counter-clockwise direction.

Start Indexer Move Input

Indexer Moves are programmed through the Network Data like every other move. The only difference is that Indexer Moves are not run until a Start Indexer Move Input makes an inactive-to-active state transition. This allows the SD31045E to run critically timed moves that cannot be reliably started from the network due to data transfer lags.

If Inputs 1 and 2 are programmed as quadrature encoder inputs and Input 3 is programmed as a Start Indexer Move Input, then the quadrature encoder position data will be captured whenever Input 3 transitions. An inactive-to-active state transition will also trigger an Indexer Move if one is pending.

Emergency Stop Input

When an input is defined as an Emergency Stop, or E-Stop Input, motion will immediately stop when this input becomes active. The driver remains enabled and power is supplied to the motor. No move can begin while this input is active.

Stop Manual or Registration Move Input

When an input is configured as a Stop Manual or Registration Move Input, triggering this input during a Manual Move or Registration will bring the move to a controlled stop. The controlled stop is triggered on an inactive-to-active state change on the input. Only Manual Moves and Registration Moves can be stopped with this input type, all other moves will ignore this input.

If Inputs 1 and 2 are programmed as quadrature encoder inputs and Input 3 is programmed as a Stop Manual or Registration Move Input, then the quadrature encoder position data will be captured when Input 3 makes an inactive-to-active transition to bring a Manual or Registration Move to a controlled stop. The encoder position data is not captured if a Manual or Registration Move is not in progress. If you want to capture encoder position data on every transition of Input 3, configure it as a Start Indexer Move Input.

Encoder Feedback

The SD31045E can be configured to accept a quadrature encoder instead of discrete inputs. Input 1 accepts the $\pm A$ pulses and Input 2 accepts the $\pm B$ pulses. Input 3 can be attached to the $\pm Z$ pulse and used to home the machine by configuring Input 3 as a Home Input.

An encoder is used by the SD31045E in one of three ways.

When the encoder is mounted on the back of the motor controlled the SD31045E, the encoder is used for position feedback or stall detection. The position data of the encoder can be preset to any value within its range, it is reported through the Network Data, and it can be captured during a move. The addition of an encoder also allows you to preform an *Encoder Move*, which is described in the [Encoder Moves](#) section, starting on page 27.

Starting with firmware 6.8, the SD31045E also has a feature called *Hybrid Control*. When using this feature, the SD31045E uses feedback from the motor mounted encoder to dynamically adjust motor current to the minimum value needed to achieve motion. Hybrid Control will also eliminate resonance induced stalls during the move.

It is also possible to use an encoder that is not mechanically coupled to the motor controlled by the SD31045E. This configuration allows you to monitor the encoder data, or use a feature called *Electronic Gearing*. When this feature is active, the SD31045E will change the position of the motor in response to a change in encoder position. The ratio of encoder turns to motor turns is fully programmable.



Available Inputs (continued)

Capture Encoder Position Input

As described in the *Start Indexer Move Input* and *Stop Manual or Registration Move Input* sections above, the SD31045E can be configured to capture the encoder position value on a transition on Input 3.

General Purpose Input

If your application does not require all three inputs, you can configure the unused inputs as General Purpose Inputs. The inputs are not used by the SD31045E, but the input state is reported in the network data.

Defining Home Position

Home Position is a known position on the machine that it must be brought to before normal operation can begin. The SD31045E allows you to define this starting position in two ways.

Position Preset Command

This command gives you the ability to preset the position value anywhere in the range of $-8,388,608$ to $+8,388,607$. The actual physical position of the machine is determined by sensors brought into the host.

Find Home CW & Find Home CCW Commands

The other way to home the machine is to attach a discrete DC sensor to one of the inputs and configure the SD31045E to use this sensor as a Home Limit Switch. You can optionally configure one or both of the other inputs as CW or CCW Overtravel Limits to define the mechanical limits of your travel. When used, these overtravel limits can affect the homing operation. The figures on the following pages show the profiles that can occur when homing the machine using a Home Limit Switch.

NOTE All of following diagrams show the results of Find Home CW Commands. Profiles for Find Home CCW commands would be identical if a CCW Limit switch was used instead of a CW Limit switch.

Simple Homing Profile

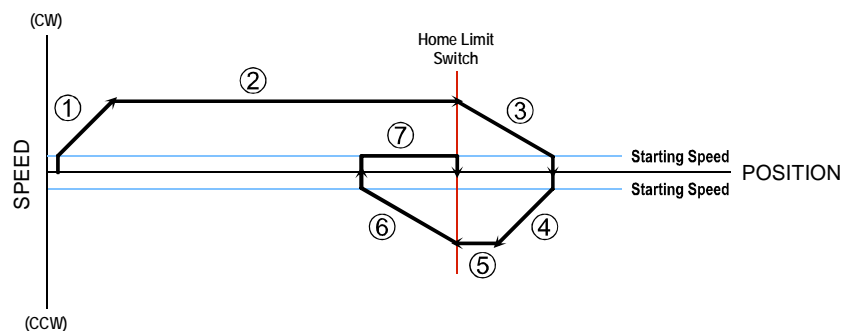

Figure 2.4 Simple Homing Profile

- 1) Begin move at the Starting Speed and accelerate to Programmed Speed.
- 2) Run at the Programmed Speed until Home Input activates.
- 3) Decelerate to the Starting Speed and stop. Wait 2 seconds before continuing.
- 4) Accelerate to the Programmed Speed in the direction opposite of the commanded direction.
- 5) Run in the direction opposite of the requested direction until the Home Input transitions from Active to Inactive.
- 6) Decelerate to a stop and wait 2 seconds.
- 7) Return to the Home Input at the programmed Starting Speed. Stop when the Home Input transitions from Inactive to Active.

Defining Home Position (continued)

Find Home CW & Find Home CCW Commands (continued)

Overtravel Limit Activates During Homing Profile

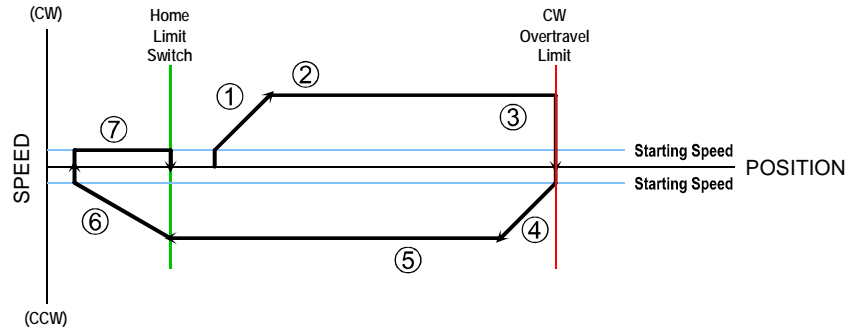

Figure 2.5 Overtravel Limit Activates During Homing Profile

- 1) Begin move at the Starting Speed and accelerate to Programmed Speed.
- 2) Run at the Programmed Speed.
- 3) Unit hits end of travel limit and immediately stops. The SD31045E waits 2 seconds before continuing.
- 4) Accelerate to the Programmed Speed in the direction opposite of the commanded direction.
- 5) Run in the direction opposite of the requested direction until the Home Input transitions from Active to Inactive.
- 6) Decelerate to a stop and wait 2 seconds.
- 7) Return to the Home Input at the programmed Starting Speed. Stop when the Home Input transitions from Inactive to Active.

Homing Operation When Home Limit Already Active

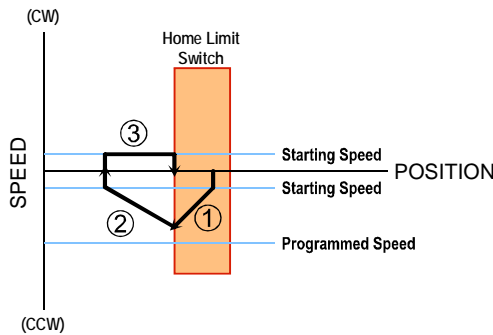

Figure 2.6 Home Limit Active

- 1) Accelerate towards the Programmed Speed in the direction opposite of the commanded direction.
- 2) Decelerate and stop when Home Input transitions from active to inactive. Wait 2 seconds before continuing.
- 3) Return to the Home Limit at the programmed Starting Speed. Stop when Home Limit transitions from inactive to active.

Defining Home Position (continued)

Find Home CW & Find Home CCW Commands (continued)

Homing Operation When Overtravel Limit Already Active

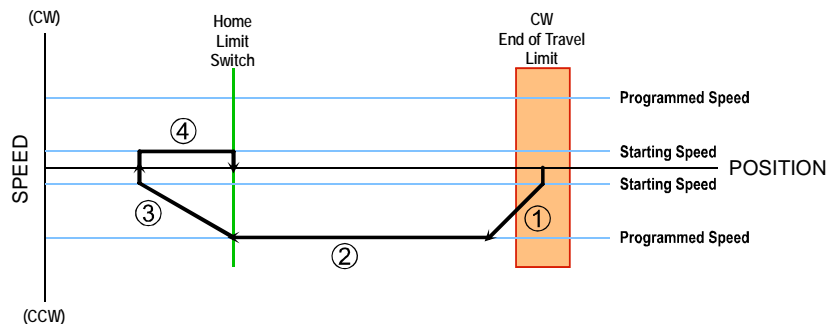

Figure 2.7 Overtravel Limit Active

- 1) Accelerate to the Programmed Speed in the direction opposite of the commanded direction.
- 2) Run in the direction opposite of the requested direction until the Home Input transitions from Active to Inactive.
- 3) Decelerate to a stop and wait 2 seconds.
- 4) Return to the Home Input at the programmed Starting Speed. Stop when the Home Input transitions from Inactive to Active.

Homing Operation with the Home Proximity Bit

Some machine configurations may activate the Home Limit input multiple times throughout the full range of motion of the machine. One such configuration is when an encoder's Z-Pulse is used to home the machine. In order to home the machine to the correct pulse, the SD31045E has a *Home Proximity* bit defined in its Network Output Data. The SD31045E will ignore all transitions on the Home Limit input until the Home Proximity bit makes a 0→1 transition. You must program your PLC to control the state of the Home Proximity Bit.

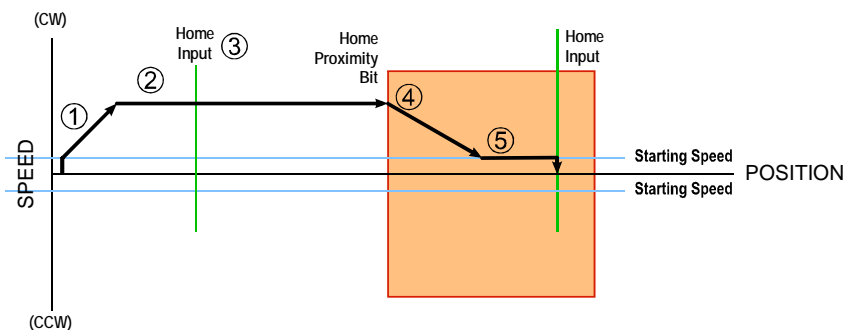

Figure 2.8 Homing with Encoder Z-Pulse

- 1) Begin move at the Starting Speed and accelerate to Programmed Speed.
- 2) Run at the Programmed Speed.
- 3) Ignore Home Limit (Z-Pulse) because the Home Proximity Bit has not made a 0→1 transition since the start of the homing operation.
- 4) Decelerate to the Starting Speed when the Home Proximity Bit makes a 0→1 transition.
- 5) Run at the programmed Starting Speed until the Home Limit (Z-Pulse) transitions from Inactive to Active.

NOTE The diagram shows the Home Proximity Bit active during states 4 and 5 of the homing operation. This is completely valid, but not necessary. The Home Proximity Bit is *transition* triggered, not level triggered.

Manual Move

When performing a Manual Move, the motor rotates in the programmed direction as long as the command bit is active. This type of move can also be stopped with an external switch, or sensor, brought directly into the SD31045E. Manual Moves are controlled with two bits in the Network Output Data. A “1” on the *CW Manual Move* bit commands a clockwise move while a “1” on the *CCW Manual Move* bit commands a counter-clockwise move. The move continues as long as the command bit is set. Note that both bits cannot be set at the same time.

Manual Moves are typically used to drive the machine under direct operator control so this type of move is also known as a Jog Move. Manual Moves can also be used when you are interested in controlling the speed of the shaft instead of its position. One such application is driving a conveyor belt. In this application you are only interested in driving the conveyor at a specific speed, and you may need to vary the speed based on environmental conditions.

As shown below, a Manual Moves begins at the programmed Starting Speed, accelerates at the programmed rate to the Programmed Speed and continues until a stop condition occurs. If it is a *Controlled Stop Condition*, the SD31045E will decelerate the motor to the starting speed and stop without losing position. If it is an *Immediate Stop Condition*, the motion stops immediately and the position becomes invalid.

It is possible to change the speed of a Manual Move without stopping the motion. The Programmed Speed, Acceleration, and Deceleration parameters can be changed during a Manual Move. When the Programmed Speed is changed, the motor will accelerate or decelerate to the new Programmed Speed using the new accelerate/decelerate parameter values. If you write a Programmed Speed to the SD31045E that is less than the starting speed, the Manual Move will continue at the Starting Speed.

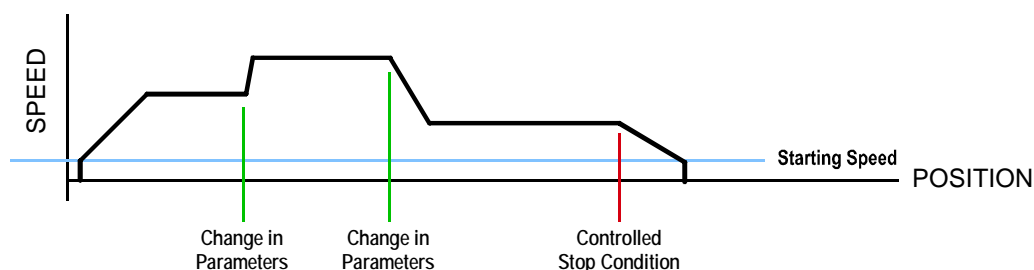

Figure 2.9 Manual Move

Controlled Stop Conditions

- The Manual Move Command bit is reset to “0”.
- A positive transition on an input configured as a *Manual Move Stop Input*.
- You toggle the Hold Move control bit in the Network Output Data. The use of the Hold Move and Resume Move bits is explained in the *Controlling Moves In Progress* section starting on page 33.

Immediate Stop Conditions

- The Immediate Stop bit makes a 0 → 1 transition in the Network Input Data.
- A positive transition on an input configured as an E-Stop Input.
- A CW/CCW Limit Switch is reached. If the limit that is reached is the same as the direction of travel, for example, hitting the CW limit while running a CW move, a *Reset Errors* command must be issued before moves are allowed in that direction again. If the limit that is reached is opposite the direction of travel, a *Reset Errors* command does not have to be issued.



Note that it is possible to *start* a move while a CW or CCW Limit Switch is active as long as the direction of travel is *opposite* that of the activated Limit Switch. For example, it is possible to start a clockwise Manual Move while the CCW Limit Switch is active.

Registration Move

Similar to a Manual Move, a Registration Move will travel in the programmed direction as long as the command is active. When the command terminates under Controlled Stop conditions, the SD31045E will output a programmed number of steps as part of bringing the move to a stop. Note that all position values programmed with a Registration Move are relative values, not absolute machine positions.

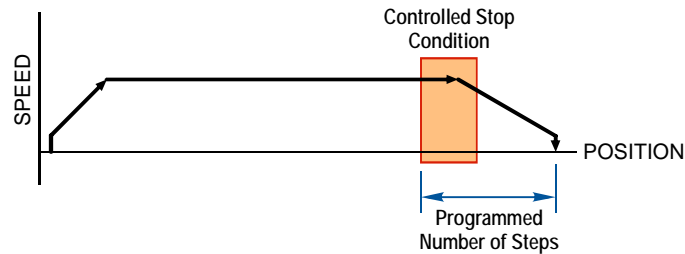

Figure 2.10 Registration Move

If the Programmed Number of Steps are less than the number of steps needed to bring the axis to a stop based on the Programmed Speed and Deceleration values set with the command, the SD31045E will decelerate at the programmed Deceleration value until it has output the Programmed Number of Steps and then stop the move without further deceleration.

An additional feature of the SD31045E is the ability to program the driver to ignore the Controlled Stop conditions until a minimum number of steps have occurred. This value is programmed through the Minimum Registration Move Distance parameter, which is set when you command the Registration Move. The figure below shows how the Minimum Registration Move Distance parameter affects when the Stop Condition is applied to the move. As shown in the second diagram, Controlled Stop conditions are level triggered, not edge triggered. If a Controlled Stop Condition occurs before the Minimum Registration Move Distance is reached and stays active, the move will begin its controlled stop once the Minimum Registration Move Distance is reached.

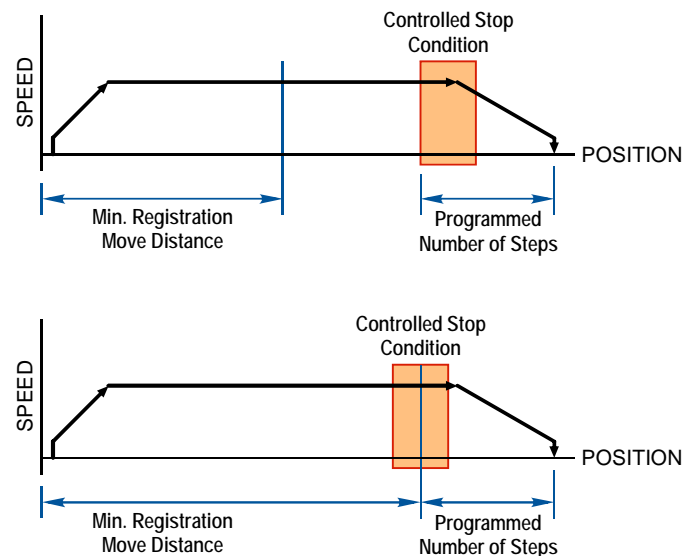

Figure 2.11 Min. Registration Move Distance

Registration Move (continued)

Controlled Stop Conditions

- The Registration Move Command bit is reset to “0”.
- A positive transition on an input configured as a *Manual Move Stop Input*.

NOTE Starting a Registration Move with a Manual Move Stop Input in its active state will result in a move of (*Minimum Registration Distance + Programmed Number of Steps*).

- You toggle the Hold Move control bit in the Network Output Data. The SD31045E responds by using the programmed Deceleration value to bring the move to a stop, without using the programmed Programmed Number of Steps. A Registration Move does not go into the Hold State if the Hold Move control bit is used to stop the move and it cannot be restarted.

Immediate Stop Conditions

- The Immediate Stop bit makes a 0 → 1 transition in the Network Input Data.
- A positive transition on an input configured as an E-Stop Input.
- A CW/CWW Limit Switch is reached. If the limit that is reached is the same as the direction of travel, for example, hitting the CW limit while running a CW move, a *Reset Errors* command must be issued before moves are allowed in that direction again. If the limit that is reached is opposite the direction of travel, a *Reset Errors* command does not have to be issued.

NOTE Note that it is possible to *start* a move while a CW or CCW Limit Switch is active as long as the direction of travel is *opposite* that of the activated Limit Switch. For example, it is possible to start a clockwise Registration Move while the CCW Limit Switch is active.

Relative Move

In a Relative Move, the motor rotates in the programmed direction for the specified number of counts.

To start a Relative Move you must specify the values of the Acceleration/Deceleration parameters, the Programmed Speed, and the *number of counts*, or position offset, to travel. A positive position offset value will cause clockwise motion, while a negative offset value will cause counter-clockwise motion.

Two relative moves of 7,500 steps are shown below. The first is with a programmed Acceleration and Deceleration rates that allow the move to reach the Programmed Speed. The second move is with low acceleration/ deceleration rates that do not allow the move to reach the Programmed Speed before deceleration must occur.

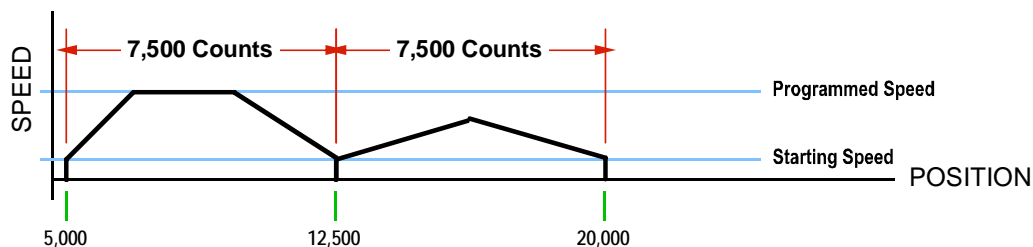

Figure 2.12 Relative Moves

- NOTE**
- 1) You do not have to preset the position or home the machine before you can use a Relative Moves. That is, the Position Invalid status bit can be set.
 - 2) Relative Moves allow you to move your machine without having to calculate absolute positions. If you are indexing a rotary table, you can preform a relative move of 30° multiple times without recalculating new positions in your controller. If you perform the same action with Absolute Moves, you would have to calculate your 30° position followed by your 60° position, followed by your 90° position, etc.

Relative Move (continued)

Controlled Stop Conditions

- The move completes without error.
- You toggle the Hold Move control bit in the Network Output Data. Note that your holding position will most likely not be the final position you commanded. You can resume a held Relative Move by using the Resume Move bit. The use of the Hold Move and Resume Move bits is explained the [Controlling Moves In Progress](#) section starting on page 33.

Immediate Stop Conditions

- The Immediate Stop bit makes a 0 → 1 transition in the Network Input Data.
- A positive transition on an input configured as an E-Stop Input.
- A CW/CWW Limit Switch is reached. If the limit that is reached is the same as the direction of travel, for example, hitting the CW limit while running a CW move, a *Reset Errors* command must be issued before moves are allowed in that direction again. If the limit that is reached is opposite the direction of travel, a *Reset Errors* command does not have to be issued.

Absolute Move

In an Absolute Move, the motor rotates from the present, known position to a programmed position. The number of counts to move and the direction of rotation are determined by the difference between the current and target positions.

Before you can perform an Absolute Move you must set the machine position to a known value. This is accomplished by using the Preset Position command or homing the machine.

To start an Absolute Move you must specify the values of the Acceleration/Deceleration parameters, the Programmed Speed, and the *Final Position* you wish to travel to. A final position greater than the starting position will cause clockwise motion. A final position less than the starting position will cause counter-clockwise motion.

Two Absolute Moves are shown below. The first is with a programmed Acceleration and Deceleration rates that allow the move to reach the Programmed Speed. The second move is with low acceleration/deceleration rates that do not allow the move to reach the Programmed Speed before deceleration must occur.

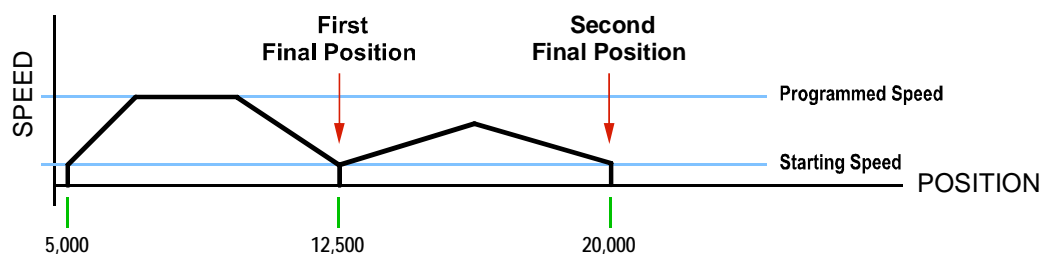

Figure 2.13 Absolute Moves

NOTE

- 1) The Motor Position must be valid before you can use an Absolute Move. The Motor Position becomes valid when you preset the position or home the machine.
- 2) Absolute Moves allow you to move your machine without having to calculate relative positions. If you are controlling a rotary table, you can drive the table to any angle without having to calculate the distance to travel. For example an Absolute Move to 180° will move the table to the correct position regardless of where the move starts from.

Absolute Move (continued)

Controlled Stop Conditions

- The move completes without error.
- You toggle the Hold Move control bit in the Network Output Data. Note that your holding position will most likely not be the final position you commanded. You can resume a held Absolute Move by using the Resume Move bit. The use of the Hold Move and Resume Move bits is explained in the [Controlling Moves In Progress](#) section starting on page 33.

Immediate Stop Conditions

- The Immediate Stop bit makes a 0 → 1 transition in the Network Input Data.
- A positive transition on an input configured as an E-Stop Input.
- A CW/CWW Limit Switch is reached. If the limit that is reached is the same as the direction of travel, for example, hitting the CW limit while running a CW move, a *Reset Errors* command must be issued before moves are allowed in that direction again. If the limit that is reached is opposite the direction of travel, a *Reset Errors* command does not have to be issued.

Encoder Moves

When the SD31045E is configured to use a quadrature encoder, the position value from the encoder can be used to control the move instead of the position of the motor. Absolute and relative type moves are both supported.

NOTE  You do not have to preset the position or home the machine before you can use a relative Encoder Move.

The figure below represents either a relative Encoder Move of 11,000 counts or an absolute Encoder Move to position 16,000. The figure shows that the encoder position you program in the move defines the point at which the motor begins to decelerate and stop. *It does not define the stopping position as it does in other move types.* The endpoint of the move depends on the speed of the motor when the programmed encoder position is reached and the deceleration values. This behavior is different from Absolute and Relative Moves where the position you program into the move is the end point of the move.

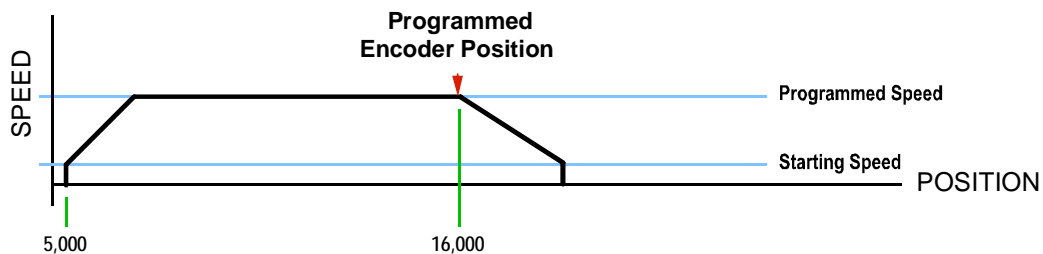

Figure 2.14 Encoder Move

Controlled Stop Conditions

- The move completes without error
- You toggle the Hold Move control bit in the Network Output Data. Note that your holding position will most likely not be the final position you commanded. You can resume a held Encoder Move by using the Resume Move bit. The use of the Hold Move and Resume Move bits is explained in the [Controlling Moves In Progress](#) section starting on page 33.



Encoder Moves (continued)

Immediate Stop Conditions

- The Immediate Stop bit makes a 0 → 1 transition in the Network Input Data.
- A positive transition on an input configured as an E-Stop Input.
- A CW/CWW Limit Switch is reached. If the limit that is reached is the same as the direction of travel, for example, hitting the CW limit while running a CW move, a *Reset Errors* command must be issued before moves are allowed in that direction again. If the limit that is reached is opposite the direction of travel, a *Reset Errors* command does not have to be issued.

Assembled Moves

All of the moves explained so far must be run individually to their completion or be stopped before another move can begin. The SD31045E gives you the ability to assemble more complex moves from a series of relative moves that are stored in memory and then run with a single command. Each Assembled Move can consist of 2 to 16 segments. Two types of Assembled Moves exist in the SD31045E:

- **Blend Move** - A Blend Move gives you the ability to string multiple relative moves together and run all of them sequentially without stopping the shaft between moves. All of the moves are in the same direction.
- **Dwell Move** - A Dwell Move gives you the ability to string multiple relative moves together, and the SD31045E will stop between each move for a programmed *Dwell Time*. Because motion stops between each segment, a Dwell Move allows you to reverse direction during the move.

An Assembled Move is stored in the RAM memory of the SD31045E and can be run multiple times once it is written to the unit. The Assembled Move data stays in memory until power is removed, the unit is sent new Configuration Data, or a new Assembled Move is written to the SD31045E. When you program an Assembled Move, it is also possible to save the move in Flash Memory. Once saved, this move is restored to RAM memory on every power up and can be run immediately by the host.

Blend Moves

Each Relative Move defines a *segment* of the Blend Move. The following restrictions apply when programming Blend Moves.

- 1) Each segment of the Blend Move must be written to the SD31045E before the move can be initiated. The SD31045E supports Blend Moves with up to sixteen segments.
- 2) Each segment is programmed as a relative move. Blend Moves cannot be programmed with absolute coordinates.
- 3) All segments run in the same direction so only the magnitude of the target position is used. (The sign of the target position is ignored.) The move's direction is controlled by the bit pattern used to start the move. If you want to reverse direction during your move, consider using the *Dwell Move* that is explained on page 30.
- 4) The Programmed Speed of each segment must be greater than or equal to the Starting Speed. The Programmed Speed must also be different from the previous segment. If you are accelerating between segments then the acceleration value of the new segment is used. If you are decelerating between segments, the deceleration value of the old segment is used.

Assembled Moves (continued)

Blend Moves (continued)

The figure below shows a three segment Blend Move that is run twice. It is first run in the clockwise direction, and then in the counter-clockwise direction.

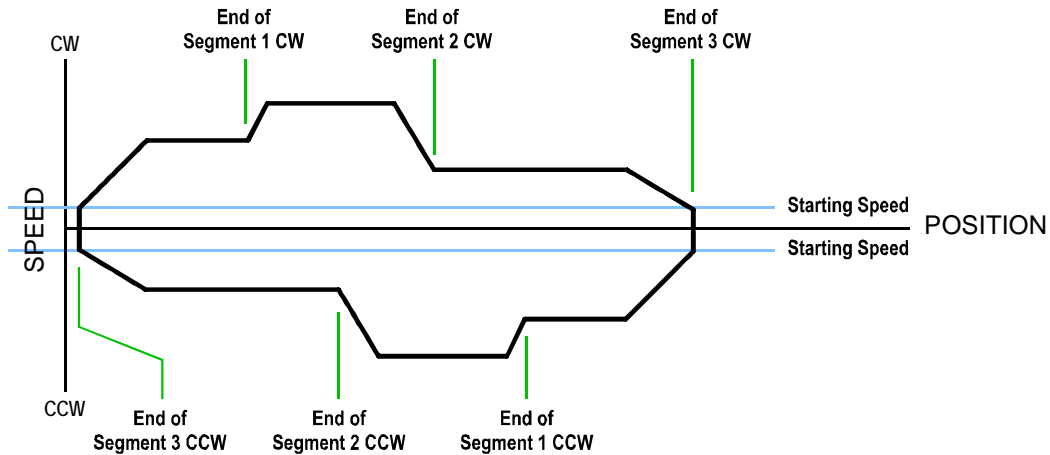

Figure 2.15 Blend Move

NOTE

- 1) You do not have to preset the position or home the machine before you can use a Blend Move. Because the Blend Move is based on Relative Moves, it can be run from any location.
- 2) There are two control bits used to specify which direction the Blend Move is run in. This gives you the ability to run the Blend Move in either direction.

Controlled Stop Conditions

- The move completes without error.
- You toggle the Hold Move control bit in the Network Output Data. When this occurs, the SD31045E decelerates the move at the deceleration rate of the present segment to the Starting Speed and ends the move. Note that your final position will most likely not be the one you commanded. The use of the Hold Move bit is explained in the *Controlling Moves In Progress* section starting on page 33.

Immediate Stop Conditions

- The Immediate Stop bit makes a 0 → 1 transition in the Network Input Data.
- A positive transition on an input configured as an E-Stop Input.
- A CW/CWW Limit Switch is reached. If the limit that is reached is the same as the direction of travel, for example, hitting the CW limit while running a CW move, a *Reset Errors* command must be issued before moves are allowed in that direction again. If the limit that is reached is opposite the direction of travel, a *Reset Errors* command does not have to be issued.

Assembled Moves (continued)

Dwell Move

A Dwell Move gives you the ability to string multiple relative moves together and run all of them sequentially with a single start condition. Like a Blend Move, a Dwell Move is programmed into the SD31045E as a series of relative moves before the move is started.

Unlike a Blend Move, the motor is stopped between each segment of the Dwell Move for a programmed *Dwell Time*. The Dwell Time is programmed as part of the move. Because the motor is stopped between segments, the motor direction can be reversed during the move. The sign of the target position for the segment determines the direction of motion for that segment. Positive segments will result in clockwise moves while a negative segment will result in a counter-clockwise move. The following figure shows a drilling profile that enters the part in stages and reverses direction during the drilling operation so chips can be relieved from the bit.

You can accomplish this Dwell Move as a series of six relative moves that you send down to the drive individually. The two advantages of using a Dwell Move in this case is that the SD31045E will be more accurate with the Dwell Time then you could accomplish in the PLC and Dwell Moves will simplify the logic of your program.

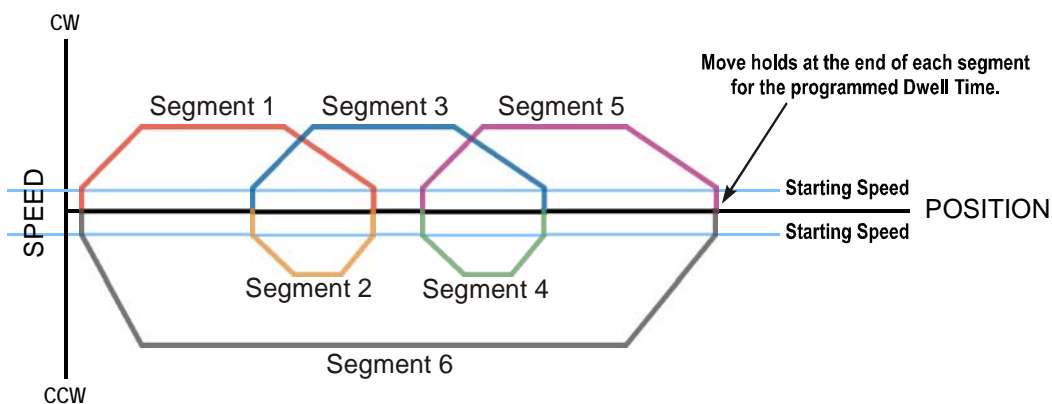

Figure 2.16 Dwell Move

NOTE

You do not have to preset the position or home the machine before you can use a Dwell Move. Because the Dwell Move is based on Relative Moves, it can be run from any location.

Controlled Stop Conditions

- The move completes without error.
- You toggle the Hold Move control bit in the Network Output Data. When this occurs, the SD31045E decelerates the move at the deceleration rate of the present segment to the Starting Speed and ends the move. Note that your final position will most likely not be the one you commanded. The use of the Hold Move bit is explained in the [Controlling Moves In Progress](#) section starting on page 33.

Immediate Stop Conditions

- The Immediate Stop bit makes a 0 → 1 transition in the Network Input Data.
- A positive transition on an input configured as an E-Stop Input.
- A CW/CWW Limit Switch is reached. If the limit that is reached is the same as the direction of travel, for example, hitting the CW limit while running a CW move, a *Reset Errors* command must be issued before moves are allowed in that direction again. If the limit that is reached is opposite the direction of travel, a *Reset Errors* command does not have to be issued.

Assembled Move Programming

All of the segments in a Blend or Dwell Move must be written to the SD31045E before the move can be run. Segment programming is controlled with two bits in the Network Output Data and two bits in the Network Input Data. Blend and Dwell Moves are programmed in exactly the same way. When you start the move, there is a bit in the command data that determines which type of Assembled Move is run. In the case of a Blend Move, the signs of the segment's Target Positions are ignored and all segments are run in the same direction. In the case of a Dwell Move, the signs of the segment's Target Positions determine the direction of the segment and the programmed Dwell Time is written to the SD31045E with the command.

Control Bits – Output Data

- **Program Move bit** – Set this bit to tell the SD31045E that you want to program a Blend or Dwell Move Profile. The SD31045E will respond by setting the *Move Program Mode* bit in the Network Input Data. At the beginning of the programming cycle, the SD31045E will also set the *Transmit Move Segment* bit to signify that it is ready for the first segment.
- **Program Move Segment bit** – Set this bit to tell the SD31045E that the data for the next segment is available in the remaining data words.
- **Save Assembled Move bit** – Set this bit if you want to store the Assembled Move in Flash memory so it is available on every power up. Setting this bit is optional and is only acted upon when the Program Move bit makes a 1 → 0 transition.

Control Bits – Input Data

- **Move Program Mode bit** – The SD31045E sets this bit to tell you that it is ready to accept segment programming data in the remaining output data words. The actual transfer of segment data is controlled by the *Program Move Segment* and *Transmit Move Segment* bits.
- **Transmit Move Segment bit** – The SD31045E will set this bit to signal the host that it is ready to accept the data for the next segment.

Programming Routine

- 1) The host sets the *Program Move* bit in the Network Output Data. If the host wants to store the move in Flash memory, the host can set the *Save Assembled Move* bit now or at any time before step 8.
- 2) The SD31045E responds by setting both the *Move Program Mode* and *Transmit Move Segment* bits in the Network Input Data.
- 3) When the host detects that the *Transmit Move Segment* bit is set, it writes the data for the first segment in the Network Output Data and sets the *Program Move Segment* bit.
- 4) The SD31045E checks the data, and when finished, resets the *Transmit Move Segment* bit. If an error is detected, it also sets the *Command Error* bit.
- 5) When the host detects that the *Transmit Move Segment* bit is reset, it resets the *Program Move Segment* bit.
- 6) The SD31045E detects that the *Program Move Segment* bit is reset, and sets the *Transmit Move Segment* bit to signal that it is ready to accept data for the next segment.
- 7) Steps 3 to 6 are repeated for the remaining segments until the entire move profile has been entered. The maximum number of segments per profile is 16.
- 8) After the last segment has been transferred, if the host wants to store the move in Flash memory, the *Save Assembled Move* bit must now be set. The host exits Assembled Move Programming Mode by resetting the *Program Move* bit.
- 9) The SD31045E resets the *Move Program Mode* bit and the *Transmit Blend Move Segment* bit.

If the Save Assembled Move bit was set when the Program Move bit made a 1 → 0 transition, the segments will be saved in Flash memory and the SD31045E will flash the Status LED green if successful or red if there was an error. Power must be cycled to the SD31045E before the drive will accept additional commands.



Indexed Moves

All of the moves that have been explained in the chapter up to this point can be started by a transition on one of the three inputs instead of a command from the network. If the *Indexed Move* bit is set when the command is issued, the SD31045E will not run the move until the configured input makes an inactive-to-active transition. This allows you to run time critical moves that cannot be reliably started from the network because of messaging time delays.

- ▶ The input must be configured as a *Start Indexed Move Input*.
- ▶ The move begins with an inactive-to-active transition on the input. An active-to-inactive transition on the input will not stop the move.
- ▶ The move command must stay in the Network Output Data while performing an Indexed Move. The move will not occur if you reset the command word before the input triggers the move.
- ▶ The state of the input is ignored once a move begins. An inactive-to-active transition on the input will not restart a move if motion is occurring.
- ▶ The move can be run multiple times as long as the move command data remains unchanged in the Network Output Data. The move will run on every inactive-to-active transition on the physical input if a move is not currently occurring. Once a move is triggered, the Start Indexed Move Input is ignored by the SD31045E until the triggered move has completed.
- ▶ As started above, a move can be run multiple times as long as the move command data remains unchanged. If you wish to program a second move and run it as an Indexed Move type, then you must have a 0→1 transition on the move command bit before the new parameters are accepted. The easiest way to accomplish this is by writing a value of 0x0000 to the command word between issuing move commands.
- ▶ A Manual Move that is started as an Indexed Move will come to a controlled stop when the command bit in the Network Output Data is reset to zero.
- ▶ It is possible to perform an Indexed Registration Move by configuring two inputs for their respective functions. The first input, configured as a *Start Indexed Move Input*, starts the move and the second, configured as a *Stop Manual or Registration Move Input* causes the registration function to occur.
- ▶ You cannot issue a Hold Command with the Indexed Bit set and have the Hold Command trigger on the inactive-to-active transition of a physical input. Hold Commands are always acted upon as soon as they are accepted from the Network Output Data.
- ▶ You cannot issue an Immediate Stop Command with the Indexed Bit set and have the Immediate Stop Command trigger on the inactive-to-active transition of a physical input. Immediate Stop Commands are always acted upon as soon as they are accepted from the Network Output Data. If you need this functionality, consider programming the physical input as an E-Stop Input.
- ▶ You cannot issue a Clear Error Command with the Indexed Bit set and have the Clear Error Command trigger on the inactive-to-active transition of a physical input. Clear Error Commands are always acted upon as soon as they are accepted from the Network Output Data.

Controlling Moves In Progress

The SD31045E has the ability to place a running move on hold and later resume the move if an error did not occur while the move was in its Hold state. One potential application for this feature is bringing a move to a controlled stop when your controller senses an end-of-stock condition. The move can be put in its Hold state until the stock is replenished and then the move can be resumed.

Note that you do not have to resume a move once it has been placed in its Hold state. You can place a move in its Hold state to prematurely end the move with a controlled stop and issue any type of new move from the stopped position.

The figure below shows a profile of a move that is placed in its Hold state and later resumed.

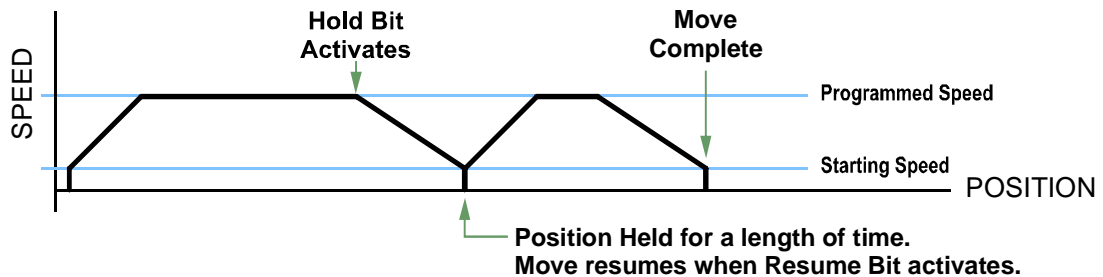

Figure 2.17 Hold/Resume a Move Profile

Find Home Moves

A Find Home command can be placed in a Hold state but cannot be resumed. This gives you the ability to bring a Find Home command to a controlled stop if an error condition occurs.

Manual Moves

Manual Moves can be placed in a Hold state and resumed if error conditions, such as programming errors, have not occurred. New Acceleration, Deceleration, and Programmed Speed parameters can be written to the SD31045E while a Manual Move is in its hold state. If these parameters are accepted without error, the move can be resumed and it will use the new parameter values.

Absolute, Relative and Encoder Moves

Absolute, Relative and Encoder Moves can be placed in a Hold state and resumed if error conditions, such as programming errors, have not occurred. New Acceleration, Deceleration, and Programmed Speed parameters can be written to the SD31045E while these moves are in their hold states. If the parameters are accepted without error, the move can be resumed and it will use the new parameter values. Note that a change to the Target Position is ignored.

Assembled Moves

A Blend or Dwell Move can be placed in a Hold state but cannot be resumed. This gives you the ability to prematurely end an Assembled Move with a controlled stop. The Assembled Move is not erased from memory and can be run again without having to reprogram it.



Electronic Gearing

The final form of motion control available with the SD31045E is Electronic Gearing. A quadrature encoder is required but it is not mounted on the motor controlled by the SD31045E. The encoder is typically mounted on a second motor, but it can be mounted anywhere, including on something as simple as a hand crank.

This mode is sometimes referred to as *encoder following*, because the motor will change position in response to a change in position of the encoder. AMCI refers to it as Electronic Gearing because the SD31045E has three parameters that allow you to set any turns ratio you want between the encoder and the motor.

Motor Steps/Turn

This is the same parameter explained at the beginning of this chapter. In Electronic Gearing mode, this parameter sets the number of encoder counts required to complete one rotation of the shaft of the motor driven by the SD31045E. It has a range of 200 to 32,767. If you set the Motor Steps/Turn parameter to four times the number of lines of your encoder, then by default your motor will complete one rotation for every rotation of the encoder.

ELGearing Multiplier and Divisor

The ratio of these two parameters sets the number of motor rotations per encoder rotation. Each parameter has a range of 1 to 255.

How It Works

The SD31045E always uses 4X decoding when counting pulses from the encoder. If you set both of your ELGearing Multiplier and Divisors to 1 and set the Motor Steps/Turn to four times the number of encoder lines, then the motor will complete one rotation for every rotation of the encoder's shaft.

Once placed in Electronic Gearing mode, the SD31045E monitors the Manual Move command bits in the Network Output Registers. When either of these bits is set, the encoder inputs are monitored for a change in position. When a change is sensed, the SD31045E will begin to turn the motor within 50 microseconds. An increase in encoder counts will result in clockwise rotation. A decrease in encoder counts will result in counter-clockwise rotation.

The values of the ELGearing Multiplier and Divisor can be changed while electronic gearing motion is occurring. The SD31045E will accelerate or decelerate the motor to match the new ratio.

Encoder position data can be trapped while in Electronic Gearing mode by configuring Input 3 as a Capture Encoder Position input.



You must also set the Acceleration and Deceleration parameters before you can put the SD31045E in Electronic Gearing mode.

Controlled Stop Conditions

- The encoder stops moving.
- Both of the Manual Move command bits equal zero.
- Electronic Gearing moves cannot be brought to a controlled stop by using the Hold Move control bit in the Network Output Registers.

Immediate Stop Conditions

- The Immediate Stop bit makes a 0 → 1 transition in the Network Input Registers.
- A positive transition on an input configured as an E-Stop Input.
- A CW or CWW Limit Switch is reached.



Electronic Gearing (continued)

Advanced Ratio Control

The ELGearing Multiplier and Divisor values give you a great deal of control over the ratio of motor turns per encoder turn, but you can achieve even finer control by adjusting the Motor Steps/Turn parameter.

The Z pulse is not used to correct the encoder position once per turn, so you can actually program the Motor Steps/Turn to any value you want within its valid range. For example, if your encoder outputs 4,096 pulse per turn (a 1,024 line encoder) and you set the Motor Steps/Turn parameter to 8,192, you will have built a 2:1 gear down into your system before applying the ELGearing Multiplier and Divisors. (Two rotations of the encoder = 8,192 counts = 1 motor rotation.)

This technique allows you to set a median gear ratio in your system that you can adjust on-the-fly by using the ELGearing Multiplier and Divisor parameters.

Stall Detection

Another feature available when using an encoder is stall detection. The encoder must be mounted on the motor controlled by the SD31045E, which means that you cannot use Stall Detection when using the Electronic Gearing feature. When Stall Detection is enabled, the SD31045E monitors the encoder inputs for changes while a move is in progress. If the encoder inputs do not change as expected, the move stops and an error bit is reported to your host controller.

In order for the Stall Detection to work correctly, you must program the *Encoder Pulses/Turn* parameter to its correct value in the Configuration Data of the SD31045E. The SD31045E always uses X4 decoding when determining the encoder position value, so the *Encoder Pulses/Turn* parameter must be set to four times the number of encoder lines. (When using a 1,024 line encoder, the *Encoder Pulses/Turn* parameter must equal 4,096 for stall detection to work correctly.)

Hybrid Control

The final feature that is available when using an encoder is *Hybrid Control*. This feature gives you servo like performance from your stepper motor without the need to tune the servo PID loop parameters.

In order for the Hybrid Control feature to work correctly, the *Encoder Pulses/Turn* parameter must be set to four times the number of encoder lines. (When using a 1,024 line encoder, the *Encoder Pulses/Turn* parameter must equal 4,096.) The *Motor Steps/Turn* parameter must also be set to this value.

The SD31045E uses the encoder feedback during a move to dynamically increase or decrease the current through the motor's windings to the lowest values needed to achieve motion. This feature eliminates the possibility of resonance induced motor stalls and can dramatically lower the motor's operating temperature.

Like a servo system, there is the possibility of a one count dither in position at zero speed and a load induced error in the final position if this feature is always enabled. The "stiffness" of the shaft, (how quickly the system compensates for shaft position error), can be adjusted with a single gain setting. The SD31045E also allows you to enable and disable the Hybrid Control feature on the fly. When the motor is at rest, a single command will disable the Hybrid Control feature, and the motor will again act as a stepper system, holding its position without dither. You can then enable the Hybrid Control feature using the same command that initiates a move, minimizing the amount of motor current needed to complete the move.

When using Hybrid Control the SD31045E has an additional status bit, the *Motion Lag* bit, that turns on if the position error becomes larger than 360°. This status bit indicates that the speed of the move is not the one that is expected, but the move is still in progress. This can be an indication that something has changed mechanically in the system that has placed an additional load on the motor. Using this bit is the preferred method of performing stall detection. When this bit turns on, monitor the encoder position value for change. If the encoder value is changing, then the motor is heavily loaded but still moving. If the encoder value is not changing, then the motor cannot rotate under load and the move can be stopped by your program. It is also possible to increase the motor current during the move as described in the [Description of Motor Current Keys](#) section found on page 80. However, you must be aware of the possibility of overheating the motor when using this feature.



Hybrid Control (continued)

When using Hybrid Control, you should always check the value of the encoder position at the end of every move and make accommodations for any load induced error in the final position.

The stall detection feature that is built into the SD31045E can be used with the Hybrid Control feature. If the rotor position becomes more than 45° behind the commanded position, the motor will be considered stalled and the move will be terminated. Error bits will be set in the network data to inform you of the stalled condition. Note that the *Motion Lag* bit will never be set when using the stall detection feature of the SD31045E because it will trip before the 360° position error that will set the *Motion Lag* bit.

Idle Current Reduction

Idle Current Reduction allows you to prolong the life of your motor by reducing its idling temperature. Values for this parameter range from 0% (no holding torque when idle) to 100%.

Idle current reduction should be used whenever possible. By reducing the current, you are reducing the I²R losses in the motor. Therefore, the temperature drop in the motor is exponential, not linear. This means that even a small reduction in the idle current can have a large effect on the temperature of the motor.

NOTE Note that the reduction values are “to” values, not “by” values. Setting a motor current to 4Arms and the current reduction to 25% will result in an idle current of 1A_{pk}. (The SD31045E always switches from RMS to peak current control when the motor is idle to prevent motor damage due to excessive heating.)

Current Loop Gain

This feature gives you the ability to adjust the gain of the power amplifiers in the SD31045E to match the electrical characteristics of your motor. The value of this parameter can range from 1 to 40 with 40 representing the largest gain increase. In general, using a larger gain will increase high speed torque but the motor will run louder. A lower gain will offer quieter low speed operation at the cost of some high speed torque.

The use of this feature is completely optional and you can leave the Current Loop Gain at its default setting of “1” for standard motor performance.

Assuming a stable line voltage of 115Vac, the following gains can be used for AMCI motors. These gain settings are factory suggestions and are average settings for our motors. Your system may benefit from increasing or decreasing these settings. In general, increase the setting by one or two counts to improve high speed performance or decrease the settings by one or two for quieter low speed operation.

		115 Vac GAIN SETTINGS							
		MOTOR CURRENT →	1 A	1.5 A	2 A	3 A	4 A	5 A	6 A
MOTOR PART #	SM2340-130			2	3	4			
	SM2340-240			4	5	6			
	SM34-450			6	9	11			
	SM34-850			11	14	17			
	SM34-1100			12	17	21			
	SM23-130 (Series)	4	6	7					
	SM23-130 (Parallel)			2	3	4			
	SM23-240 (Series)	6	8	10					
	SM23-240 (Parallel)			4	5	6			
	SM42-1800				10	11	12	14	

Table 2.1 Optional 115Vac Current Loop Gain Settings

Current Loop Gain (continued)

		230Vac GAIN SETTINGS						
		MOTOR CURRENT →	1 A	1.5 A	2 A	3 A	4 A	4.4 A
MOTOR PART #	SM2340-130				1	1	1	
	SM2340-240				2	3	3	
	SM34-450				3	4	5	
	SM34-850				6	7	8	
	SM34-1100				8	9	10	
	SM23-130 (Series)	2	3	3				
	SM23-130 (Parallel)				1	1	1	
	SM23-240 (Series)	3	4	5				
	SM23-240 (Parallel)				2	3	3	
	SM42-1800					5	6	7

Table 2.2 Optional 230Vac Current Loop Gain Settings



Notes

GENERAL INSTALLATION GUIDELINES

This chapter gives general information on installing electronic controls in an industrial environment including the importance of proper wiring, grounding, and surge suppression. If you are responsible for installing the SD31045E, make sure you are familiar with these practices and follow them when installing the unit.

These instructions assume a solidly grounded system, which is used in a vast majority of modern industrial systems. As defined by the IEEE, a solidly grounded system is one in which the neutral of a generator, power transformer, or grounding transformer is directly connected to the system ground or earth. The installation of ungrounded systems is not covered by these instructions.



WARNING

This chapter is presented as a tool in the hopes of avoiding common installation problems. It is not a substitute for the safety practices called out in local electrical codes or, in the United States, the National Electrical Code published by the National Fire Protection Association. If *any* conflicts exist, local and national codes must be followed. *It is the responsibility of the user* to determine what installation practices must be followed to conform to all local and national codes.

Safety is the single most important objective of any electrical installation. The system must be safe to use and it must be able to detect unsafe conditions and remove power when these conditions occur.

The second important objective of an electrical installation is proper and consistent operation. Proper operation can be achieved through:

- Proper Grounding
- Suppression of electrical noise generated by the machine.
- Suppression of electrical noise coming in from the environment. (Other machines, power surges, etc.)

Grounding

Proper grounding is the single most important consideration for a safe installation. Proper grounding also ensures that unwanted electrical currents, such as those induced by electromagnetic noise, will be quickly shunted to ground instead of flowing through the machine.

Earth ground connections on electronic controls are one of two types.

- **Protective Earth Connection:** Point that must be tied to Earth for the safe operation of the device. (Protection against electric shock should the device be damaged.)
- **Functional Earth Connection:** Point that must be tied to Earth to improve noise immunity of the device.

For the AMCI SD31045E, the Protective Earth Connection is any mounting surface of the unit. The Functional Earth Connection of the SD31045E is the ground terminal (GND) on the power connector.

Grounding Electrode System

The Grounding Electrode System is the common name for the building's earth ground infrastructure. This system *defines* earth-ground potential within a building and is the central ground for all electrical equipment.

Ground Bus

AMCI strongly suggests the use of a ground bus in each system enclosure. The ground bus is simply a metal bar with studs or tapped holes for accepting grounding connections in the enclosure. The ground bus is the only component in the enclosure that is directly connected to your Grounding Electrode System. Therefore, the ground bus becomes the central grounding point for the enclosure and its equipment.

Grounding (continued)

Grounding Electrode Conductor

Connection of the ground bus to the Grounding Electrode System is made with the Grounding Electrode Conductor. The Grounding Electrode Conductor should be the shortest length of stranded wire or braid possible. The American NEC allows a length of up to six feet, but shorter is better. A shorter length will help shunt high frequency noise to the Grounding Electrode System.

In extremely noisy environments, it is sometimes advisable to run two wires from the ground bus to the GES. The length of these two wires should differ by 20% to 30% so they offer different impedances to the noise frequencies being shunted to earth ground.

The minimum sizes for the Grounding Electrode Conductor are #8 AWG stranded wire or 1" braid, but larger sizes may be needed depending on the total ground fault current your system can generate. The actual size is determined by the size of the largest conductor in the system.

The American NEC allows the use of a solid wire for the Grounding Electrode Conductor but this should be avoided. High frequency currents (electrical noise) travel along the surface of a conductor. Heavy gauge stranded wire and braid both have large surface areas, solid conductors do not. Therefore, stranded wire and braid have a much lower effective resistance to electrical noise.

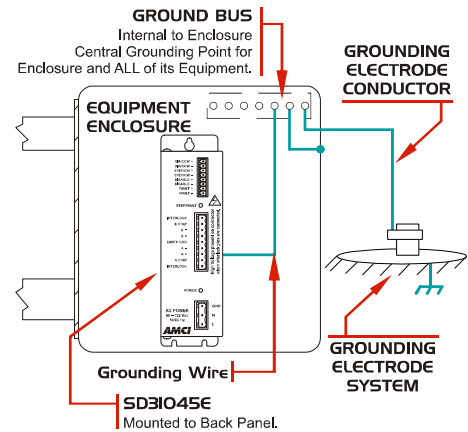

Figure 3.1 Grounding Components

Grounding Wires

Grounding wires are used to connect the pieces of equipment to your ground bus. AMCI strongly suggests using #8 AWG stranded wire or 1" wire braid for all grounding connections. The American NEC allows the use of solid wire for grounding wires but this should be avoided for the same reasons they should not be used for the Grounding Electrode Conductor.

Avoiding Grounding Problems

As stated before, there are two reasons to properly ground a system. The first reason is to protect human life. A properly designed grounding system will be able to detect potential shock currents and remove power from the system. The second reason is to improve system reliability by shunting electrical noise currents to earth instead of allowing them to flow through the system where they can disrupt the operation of electronic controls.

The entire grounding system, even though conductive, is not meant to carry current except under fault conditions.



Under normal operating conditions, the grounding system should not carry any current at all.

Ground Fault Interrupt (GFI) circuits depend on this condition to work correctly. Any ground current flowing through a GFI is considered a fault condition and the GFI immediately opens to remove power from the faulted circuit.

By this definition, electrical noise and other transient currents such as inductive spikes are considered fault currents. The fact that these currents are very short lived and of relatively small amperage allows them to be safely shunted without tripping a Ground Fault Interrupt circuit.

Avoiding Grounding Problems (continued)

Grounding problems occur when the grounding system carries currents during normal operation or when it cannot shunt high frequency electrical currents to earth.

AMCI generally encounters three types of grounding problems in systems that use AMCI equipment.

- ▶ **Ground Loops:** A ground loop occurs when AC or DC return currents can travel through the system ground path in addition to their normal return path. This can cause damaging currents to electronics that share the power supply.

Ground loops in AC systems can occur when the neutral conductor is bonded to the Grounding Electrode System in more than one place. Under the right conditions, AC line currents may end up flowing through the protective ground system, which may include exposed metal surfaces and therefore represent a touch shock hazard. Designing an effective ground fault detection system is well beyond the scope of this manual. Please refer to the NEC and other design guidelines for your area.

- ▶ **Ground Shift:** Remote machines or monitoring stations will usually be connected to a different point on the Grounding Electrode System than a local system. A voltage potential can exist between these stations due to resistance between the grounding electrodes and earth. A similar problem exists on machines that are not properly bonded together. The resistance of a poor bond in the system will result in a voltage potential across the connection when current is forced through it. Incorrectly installed sensor or communications cables that run between these systems can be damaged by these Ground Shift potentials.
- ▶ **High Impedance Grounds:** The grounding system shows a high impedance to high frequency noise currents and these signals are not properly shunted to earth. The high impedance to high frequency noise is caused by capacitance and inductance in the system. Use #8 AWG stranded wire or 1" wire braid for all ground connections and keep connections as short as possible to minimize capacitance and inductance in the grounding system.

Surge (EMI) Suppression

Incoming Power

In many systems, three phase power is brought to the machine and the control system is powered these phases. In these cases, good quality, clean AC power can only be achieved by properly conditioning the three phase power, not just the power used by the control system. This is generally achieved by placing surge suppressors across each phase where the three phase enters the system and at all inductive loads that are on the three phase branch. This includes inductive loads *on any other machine* that may be powered by the same feeder circuit.

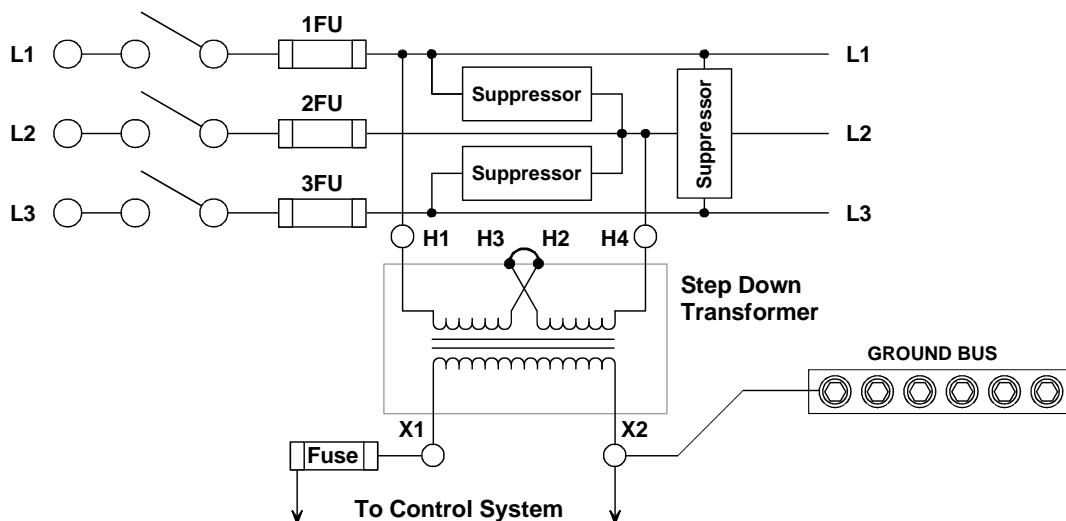

Figure 3.2 Surge Suppression on Power Inputs

Surge (EMI) Suppression (continued)

Inductive Loads

NOTE All inductive devices in the system, such as AC and DC motors, motor starters, contactors, relays and solenoids, must have surge suppression devices installed across their coils.

NOTE Because the SD31045E is responsible for commutating the stepper motor, surge suppressors cannot be installed at the motor connector. The best way to avoid noise issues when using a stepper motor is proper cable installation. Keep the motor wires as short as possible. Consider twisting the winding pairs together to minimize radiated noise. Use shielded cable if you must extend the cable and tie the shield to earth ground at the SD31045E motor connector only.

System Environment

When designing the physical layout of your system it is important to review the environment your control system will be placed in. This should include reviews of both the physical and electrical environments.

- Check the quality of the AC power that will feed the machine.
- Check for adequate surge suppression on machines that will be near your new system.

A review of the electrical environment includes checking the quality of the AC power that will feed your new system as well as checking the quality of the point where your system will be connected to the building's Grounding Electrode System.

When checking the quality of the AC power for your system, be sure to check every machine that may be powered by the same feeder circuit. It has been in AMCI's experience that nuisance faults can be caused by another system on the same feeder circuit that does not have adequate surge suppression devices.

System Layout Considerations

The first step to achieving a clean system layout is classifying the wires and cables used in your system based on the amount of power they carry. Refer to the following table to help you categorize your wires and cables.

Category	Description	Examples
1	Control and AC Power - High power conductors that are more tolerant of electrical noise but are also more likely to carry electrical noise than the other categories. Corresponds to IEEE levels 3 & 4	AC power lines High power digital AC I/O lines High power digital DC I/O lines High power I/O lines typically connect to devices such as mechanical switches, relays, and solenoids. Stepper Motor wiring also falls into this category.
2	Signal and Communication - Low power conductors that are less tolerant of electrical noise but are also less likely to carry electrical noise than category 1. Corresponds to IEEE levels 1 & 2	Analog I/O lines Low power digital AC I/O lines Low power digital DC I/O lines Ethernet or other Communications Cables Low power I/O lines typically connect to devices such as proximity switches, photo sensors, and encoders.
3	Intra-enclosure - Similar characteristics to category 2 conductors, these conductors interconnect system components within an enclosure.	Low voltage DC power cables Communications Cables

Table 3.1 Conductor Categories

Wiring Categories for the SD31045E

- AC Power Input: Class 1 (AC power line)
- DC Input cables (also included encoder cabling): Class 2 (Low power digital DC input line)
- DC output cable: Class 2 (Low Power digital DC output line)
- Motor Outputs: Class 1 (High Power DC outputs)

System Layout Considerations (continued)

Minimize Voltages in the System Enclosure

You will want to minimize the voltage in the enclosure that houses your control system to minimize EMI and voltage transients. In many cases, three phase is used to power the machine's motors and the control system is powered by one of the phases. Ideally, the three phase power, it's disconnect, fuses, filtering, and all three phase controls such as motor starters, are housed in their own enclosure. The single phase used to power the control system is then brought into a separate enclosure built exclusively for the control system.

Power Supply Sizing

A properly sized power supply is vital to system operation. The best guideline that we can give you is to buy the best supply your budget allows and consider the surge requirements of the components you are attaching to the supply.

Component Placement

Once you have established the proper categories of all of the system's wires and cables and determined all of you components, including surge suppressors, you can determine proper component placement and conductor routing within the system enclosure.



The following guidelines are for noise immunity only. Follow all local codes for safety requirements.

There are three general guidelines to follow when placing components:

- Keep as much physical space between the classes of conductors as possible.
- Minimize the distance that conductors run in parallel with each other to minimize capacitive coupling.
- If conductors must cross, they should do so at right angles to minimize inductive coupling.

If you have a PLC in your system, be sure to consider the spacing of the modules within the rack. Do not place an AC output module next to low level DC input module unless absolutely necessary. For example, consider placing low level input modules on the left side of the rack, high power AC output modules on the right side, and medium power I/O in the center. This should help you maximize the spacing of I/O wiring within the enclosure.

System Layout Considerations (continued)

Conduits to Enclosure

When designing the layout of your system be sure to include enough conduits to house the different categories of cabling. To guard against coupling noise from one conductor to another, follow the spacing guidelines in table 3.2 below. These spacing values should be followed for routing cables both inside and outside of an enclosure. Of course, sometimes these guidelines cannot be followed, such as when the connection points on a controller are spaced closer together than these guidelines recommend.

Category	Guidelines
1	These conductors can be routed in the same cable tray, raceway, or conduit as machine power conductors of up to 600Vac. Power conductors cannot feed larger than 100HP devices.
2	<ul style="list-style-type: none"> ▶ If they must cross power feeds, they must do so at right angles. ▶ Route in a raceway or conduit separate from all category 1 conductors and properly shield where applicable. ▶ Any metal wireway or conduit that houses the conductor must be bonded along its entire length and bonded to the enclosure at its entry point. ▶ If in a continuous metal wireway or conduit, route at least 3" from category 1 conductors of less than 20A, 6" from category 1 conductors of greater than 20A and 12" from any category 1 conductor of any amperage of the circuit is greater than 100 kVA. ▶ If not in a continuous metal wireway or conduit, route at least 6" from category 1 conductors of less than 20A, 12" from category 1 conductors of greater than 20A and 24" from any category 1 conductor of any amperage of the circuit is greater than 100 kVA. ▶ Route at least 5 ft. away from high-voltage enclosures or sources of rf/microwave radiation.
3	Route these conductors external to all raceways in the enclosure or in a raceway separate from all category 1 conductors. Use the same spacing rules given for category 2 conductors.

Table 3.2 Conductor Routing Guidelines

Installing a SD31045E

The SD31045E is designed to be mounted in an enclosure that is close to the motor. On small machines, this may be the same enclosure that the rest of the control system is mounted in. On large machines, this is typically a small enclosure that only houses the SD31045E.

- ▶ A minimum of two conduits are required for the SD31045E enclosure. One for the DC I/O and ethernet cable, and one for AC power and the motor connections. Three conduits may be required if the code in your area does not allow you to run the motor connections with AC power or if the noise generated on the motor connections is injected into your AC lines.
- ▶ If 115Vac is the only line voltage available in the system and you require the 310Vdc motor bus, a step up transformer that is rated for a minimum of 800VA must be installed. Consider installing this transformer in the enclosure with the SD31045E. This will prevent any noise placed on the AC line by the SD31045E from leaving the enclosure.
- ▶ Like all motors, stepper motors are noise generators and must be properly grounded when installed.
- ▶ Keep the motor wires as short as possible. Consider twisting the winding pairs together to minimize radiated noise. Use shielded cable if you must extend the cable and tie the shield to earth ground at the SD31045E motor connector only.

This chapter gives detailed information on installing the SD31045E. The person responsible for installing the SD31045E should be familiar with the general installation guidelines given in the previous chapter.

Outline Drawing

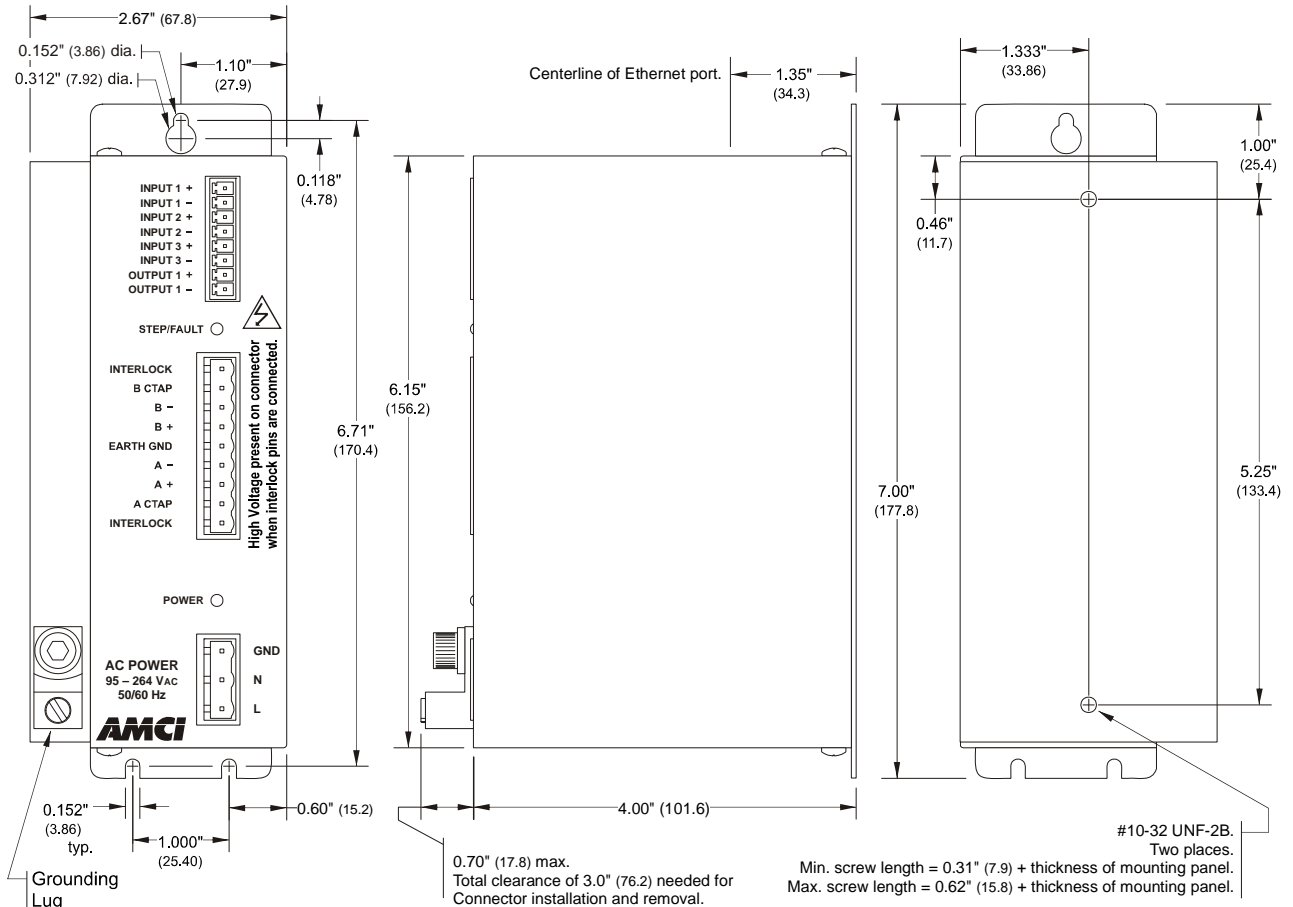

Figure 4.1 SD31045E Outline Drawing

Mounting Methods

There are two ways to mount the SD31045E. The first method is with two #10-32 screws into the back panel. The second method is by the mounting tabs. Mounting tabs are for #6 screws.



WARNING

When using the back panel mounting method, minimum and maximum screw lengths should be observed to prevent a screw from shorting to the PC Board or components.



NOTE

There are airflow holes in the top and bottom of the enclosure. To ensure adequate convectional airflow, the drive must be mounted in the orientation shown in the drawing.

Airflow and Wiring Space

To ensure adequate airflow and wiring space, you need two inches (50 mm) of space above and below the driver, one and one-half inches (37 mm) of space to the left and right of the driver, and one inch (25 mm) of space in front of the driver. These dimensions are typical for convectional cooling. If you have an active cooling system such as enclosure fans, you will be able to mount the drivers closer together.

Grounding and Powering the System

WARNING

The chassis must be connected to earth ground. Failure to properly ground the chassis leaves the potential for severe electrical hazard and/or problems with normal operation.

The SD31045E must be grounded for proper operation. The **GND** connection on the power connector is connected to the SD31045E enclosure and is a sufficient grounding point for most applications. A ground lug is also available. When mounted the SD31045E on a surface that is electrically conductive and grounded, you should take steps to ensure that the two are electrically bonded together. If necessary, remove paint from the surfaces of the panel that contact the mounting bolts to ensure adequate electrical bonding.

AC power connections are made to the SD31045E using the power connector kit that ships with the driver. This kit includes the power connector and rubber boot. Figure 4.1 below shows how to properly wire and ground the driver.

NOTE

For clarity, the rubber boot is not shown in the figure. When installing the power cable, slide the rubber boot onto the cable before wiring the connector. When you're sure the wiring is correct, slide the boot over the connector to cover the screw heads.

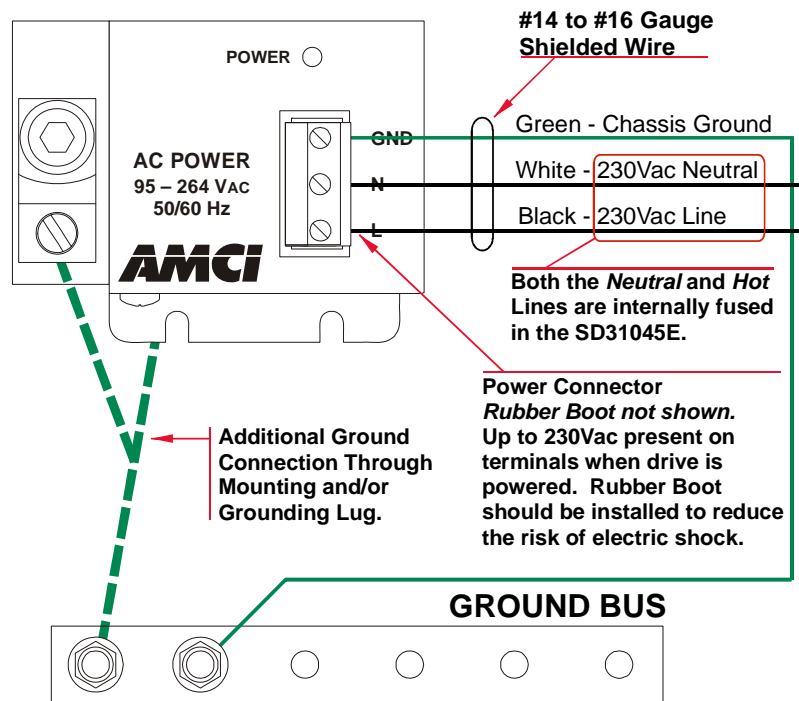

Figure 4.2 Power and Grounding Connections

NOTE

- 1) Input power must be 95 to 264 Vac, 50/60 HZ, and able to supply 800VA for proper operation.
- 2) Both the Neutral and the Line power connections are internally fused in the SD31045E. These fuses are not field replaceable, so external fuses or circuit breakers should also be used. They must be rated for at least 10 amps.

Installing the Stepper Motor

Outline Drawings

Outline drawings for all of our motors can be found on our website, www.amci.com, in the *PDF Documents* section. They're available as Adobe Acrobat pdf files. A document that is simply called *wiring* lists all of the wiring color codes for all AMCI motors. If you do not have internet access contact AMCI and we will fax the information to you.

Mounting the Motor

All AMCI motor have flanges on the front of the motor for mounting. This flange also acts as a heatsink, so motors should be mounted on a large, unpainted metal surface. Mounting a motor in this fashion will allow a significant amount of heat to be dissipated away from the motor, which will increase the motor's life by reducing its operating temperature. If you cannot mount the motor on a large metal surface, you may need to install a fan to force cooling air over the motor.

Motors should be mounted using the heaviest hardware possible. AMCI motors can produce high torques and accelerations that may weaken and shear inadequate mounting hardware.

NOTE

- 1) The motor case must be grounded for proper operation. This is usually accomplished through its mounting hardware. If you suspect a problem with your installation, such as mounting the motor to a painted surface, then run a bonding wire from the motor to a solid earth ground point near it. Use a minimum #8 gauge stranded wire or 1/2" wire braid as the grounding wire
- 2) Do not disassemble *any* stepper motor. A significant reduction in motor performance will result.

Connecting the Load

Care must be exercised when connecting your load to the stepper motor. Even small shaft misalignments can cause large loading effects on the bearings of the motor and load. The use of a flexible coupler is *strongly* recommended whenever possible.

Extending the Motor Cable

Even though it is possible to extend the cable length an additional forty feet, AMCI recommends installing the SD31045E as close to the motor as possible. This will decrease the chances of forming a ground loop, and has the added benefit of limiting the amount of power loss in the motor cable. If you must extend the cable, you should use a cable with twisted pairs 18 AWG or larger and an overall shield. For SM42's use 14 AWG or larger cable with an overall shield. Belden 9554 (eight wire), 9553 (six wire) and 9552 (four wire) meet these specifications for 18 AWG+. Belden 1070A (eight wire), 1527A (six wire) and 1069A (four wire) meet these specifications for 14 AWG+.

Installing the Motor Cable

NOTE

- 1) All of the motor connections are high power, high voltage signals. Cable from the motor can be installed in conduit along with ac/dc power lines or high power ac/dc I/O. It cannot be installed in conduit with low power cabling such as I/O cabling or Ethernet cabling attached to the SD31045E.
- 2) If you decide to extend the motor cable, treat the shield as a signal carrying conductor when installing the motor cable. Do not connect the shield to earth ground at any junction box.

Connecting the Motor

Motor Connector

The motor connector is shown in figure 4.3. The two Interlock terminals are a safety feature. When these two terminals are not connected, the driver will not power the motor outputs, the Status LED turn on red, and it activates the Fault Output. For normal operation, these two terminals must be connected together with a short wire.

The two center tap pins, A CTAP and B CATP, are there for wiring convenience only. They are electrically isolated from the rest of the driver and are not used to power the motor. The **EARTH GND** pin is for the shields of the motor cable. This pin is directly connected to the grounding lug of the SD31045E.

NOTE When powered, the motor connector represents a shock hazard because it has up to 310 Vdc present on its terminals. A rubber boot that is included with the connector must be installed but is not shown in the following figures for clarity. When installing the motor cable, slide the rubber boot onto the cable before wiring the connector. When you're sure the wiring is correct, slide the boot over the connector to cover the screw heads.

WARNING Always remove power from the SD31045E before connecting or disconnecting the motor.

NOTE

- 1) Never connect the motor leads to ground or to a power supply.
- 2) Always connect the cable shield to the Earth Ground terminal of the SD31045E's Motor Connector.

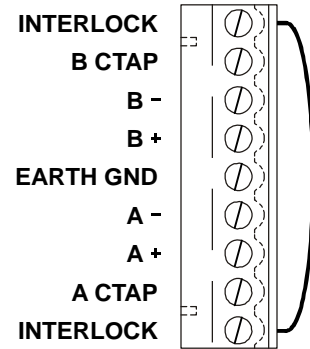

Figure 4.3 Motor Connector with Interlock Jumper

Interlock Wiring

The motor interlock is designed to prevent 310Vdc voltage from being supplied to the motor connector unless its mate is installed. As shown in figure 4.3 above, a short wire has to be installed between the two outer pins of the mating connector or the motor will not receive power when it is plugged into the SD31045E.

Using the Interlock for Emergency Stops

Prior to revision 5.6, the Interlock terminals were meant solely as a safety feature, not an alternate way to disable the motor. AMCI strongly suggested only using a short jumper to connect these pins and not running this connection through relay contacts.

With the release of revision 5.6, the Interlock circuitry has been redesigned and it is now possible to use the Interlock terminals as an alternative way of disabling motor current. This is accomplished by wiring the two pins through a mechanical contact. The wires to the Interlock pins should be kept as short as possible, which means using a mechanical relay in the cabinet that houses the SD31045E if you need to control the Interlock from a source outside the cabinet. Only mechanical relays should be used. The voltage between the two interlock pins will never exceed 5Vdc, but the full AC voltage used to power the driver may be present between either of the two interlock pins and either of the power supply pins.

When the SD31045E detects a break in the Interlock wiring, it will issue a *Driver Fault* error. This error is latched and can only be cleared after the interlock connection is re-established. The fault can be cleared over the network by following the procedure outlined in [Notes on Clearing a Driver Fault](#) which starts on page 94 or by cycling power to the driver.

Connecting the Motor (continued)

Motor Wiring

The SD31045E will work with many different motors, including those not sold by AMCI. This section assumes that you have already chosen your motor and you are looking for wiring information. No wire colors are given in the figures below because there is no single industry wide color coding scheme for stepper motors. You must refer to your motor data sheets for this information.

A wiring document for all of the motors ever sold by AMCI is available on our website. This single document contains all of the information necessary to connect any AMCI motor to any AMCI driver. At the time of this manual revision, the wiring manual can be found in the *PDF Documents* section of the website. It is under the *Stepper Motor* heading, and link is simply called “wiring”.

Figure 4.4 shows how to wire a motor to the SD31045E in series, parallel, or center-tap configurations.

Eight Lead Series Connected

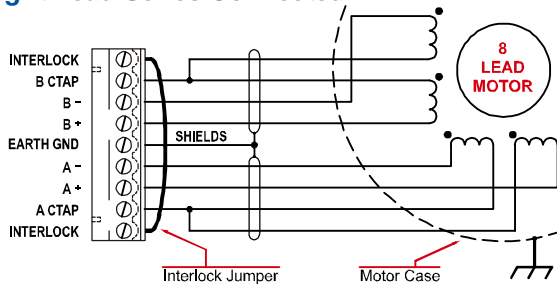

Eight Lead Parallel Connected

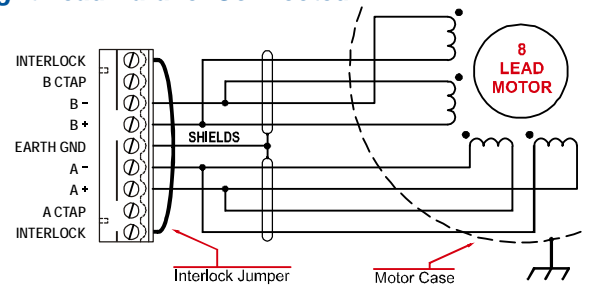

Six Lead Series Connected

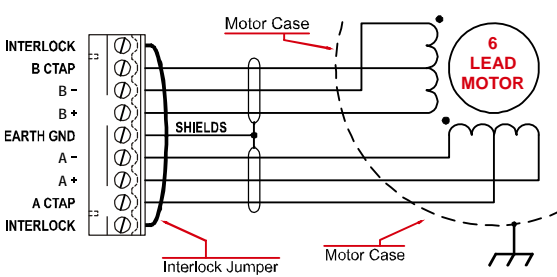

Six Lead Center Tap Connected

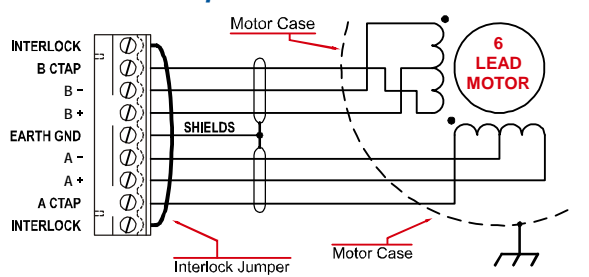

Four Lead Connected

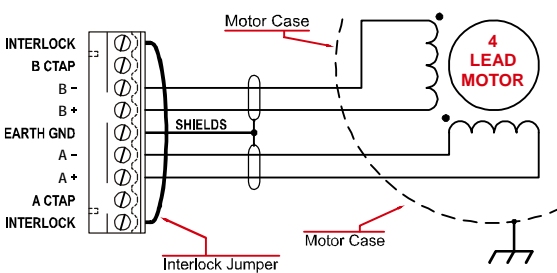

NOTES

- 1) Refer to the torque vs. speed curves on your motor's specifications sheet to determine if you should wire the motor to the SD31045E in series, parallel, or center-tap configurations.
- 2) Motor connections should be tight. Loose connections may lead to arcing which will heat the connector. Phoenix Contact specifies a tightening torque of 4.4 to 5.4 lb-in (0.5 to 0.6 Nm)

Figure 4.4 Motor Wiring

I/O Wiring

Input Wiring

Figure 4.5 below shows how to wire discrete DC differential, sourcing, and sinking sensors to Inputs 1, 2, and 3 of the SD31045E. Encoders typically have differential outputs, but must be wired to the SD31045E in a specific way. More information on wiring an encoder is given later in this chapter.

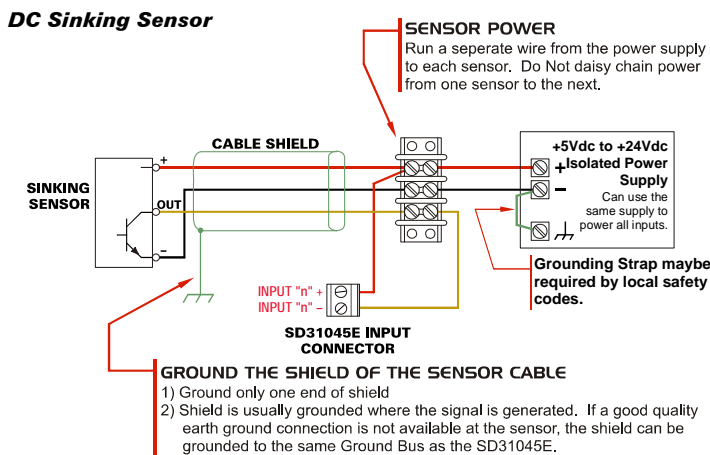
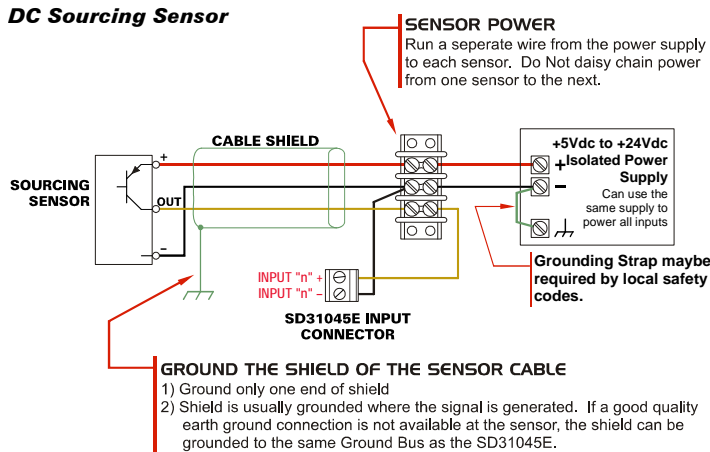
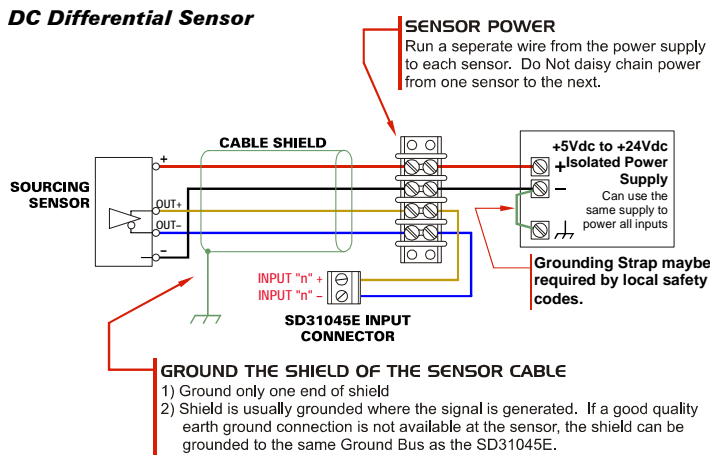

Figure 4.5 Input Wiring

Input Specifications:

Differential. 1500 Vac/dc opto-isolated. Can be wired as single ended inputs. Accepts 3.5 to 27Vdc without the need for an external current limiting resistor.

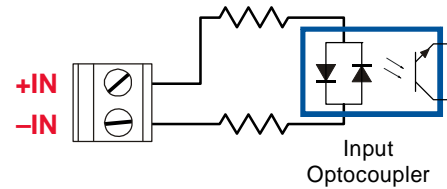

Figure 4.6 Simplified Input Schematic

Because they are low power signals, cabling from the sensor to the SD31045E should be done using a twisted pair cable with an overall shield. The shield should be grounded at the end when the signal is generated, which is the sensor end. If this is not practical, the shield should be grounded to the same ground bus as the SD31045E.

INSTALLING THE SD31045E

I/O Wiring (continued)

Output Wiring

SD31045E Output - Sourcing Connection

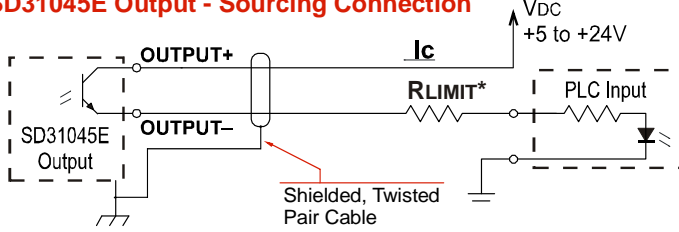

The SD31045E output is an optically isolated transistor that is capable of driving a typical PLC input. Both ends are uncommitted, so it can be wired as a sinking or sourcing output.

Electrical Specifications

VDC max: 30Vdc	VCE SAT: 1Vdc @ 20 mA
Ic max: 20 mA	Power Dissipation: 20 mW max.

SD31045E Output - Sinking Connection

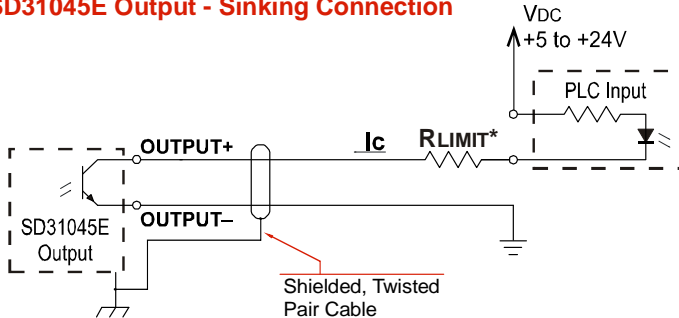

RLIMIT

A resistor may be needed to limit the current through the output. The value, and power rating of the resistor is dependent on the value of Vdc, the voltage drop across the input, and the current requirements of the input.

Figure 4.7 Output Wiring

Encoder Wiring

The figure below shows how to wire a 5Vdc differential encoder to the SD31045E.

- The ±A channel must be wired to Input 1 for proper operation
- The ±B channel must be wired to Input 2 for proper operation
- The ±Z channel is optional. If used, it must be wired into Input 3. The Z channel is only used when homing the SD31045E.



Figure 4.8 Sample Encoder Wiring

Ethernet Connection

The Ethernet connector is located on the top of the SD31045E. The connector is a standard RJ-45 jack that will accept any standard 100baseT cable. Because the port can run at 100 Mbit speeds, Category 5, 5e, or 6 cable should be used.

The Ethernet port on the SD31045E has “auto switch” capability. This means that a standard cable can be used when connecting the SD31045E to any device.

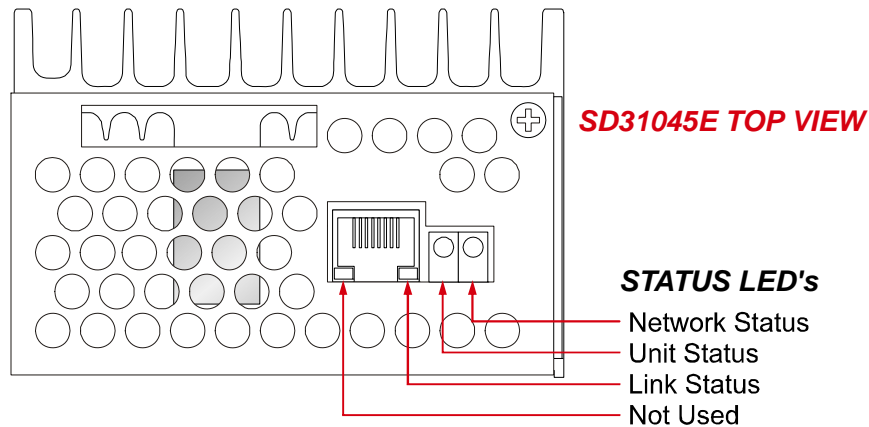

Figure 4.9 Ethernet Port Location

Network Status LED's

The status LED's indicate the health of the network connection between the SD31045E and its host. The Status LED on the front of the unit indicates the state of the SD31045E itself.

- ▶ **Network Status (EtherNet/IP)** – Indicates the status of the connection between the SD31045E and its host.
- ▶ **Network Status (Modbus/TCP)** – Indicates the number of TCP connections to the SD31045E.
- ▶ **Unit Status** – Indicates the status of the connection between the SD31045E and its Ethernet daughter board.
- ▶ **Link Status** – On when there is a physical link between the Ethernet port of the SD31045E and the Ethernet port of the device the SD31045E is plugged into.

The Network Status LED's are fully described in the [Ethernet Port](#) section of this manual starting on page 15.

CHAPTER 5

NETWORK CONFIGURATION

This chapter covers how to configure the IP address of the SD31045E and set the communications protocol by using the AMCI Ethernet Configurator software. It is also possible to use a Bootp server to set the IP address of the SD31045E. Instructions on using the Bootp server from Rockwell Automation are available in Appendix A.

Factory Default

Each SD31045E ships from the factory with a default IP address of 192.168.0.50 and a subnet mask of 255.255.255.0. An SD31045E retains its IP address when power is removed and there is no hardware reset button. The address of your SD31045E may be different if your unit is not directly from the factory.

Assumptions

This chapter makes a few assumptions:

- 1) You understand how IP addressing works and you only need instructions on setting the IP address of your SD31045E. If you do not yet understand IP addressing, there is plenty of information on the Internet. At the time of this writing, entering the phrase "ip addressing tutorial" into a popular search engine returned 93,000 hits.
- 2) You have administrative privileges on the computer you are using to configure the SD31045E. You will only need these privileges if you have to change the IP addressing of the network interface card used when configuring the unit.
- 3) You are configuring an SD31045E that has the factory default address of 192.168.0.50 and a subnet mask of 255.255.255.0. If you have an SD31045E that has already been configured with a different address, you must know this address and adjust these instructions accordingly. If you do not know the address of the SD31045E, the AMCI Ethernet Configurator software will still be able to connect to the module if they reside on the same subnet.

Firewalls

Firewalls are hardware devices or software that prevent unwanted network connections from occurring. Firewall software is present in Windows XP and above and it may prevent your computer from communicating with the SD31045E. If you think that your firewall may be interfering with the AMCI Ethernet Configurator software, then the easiest thing to do is temporarily disable the firewall from the Control Panel and enable it once you have finished configuring the SD31045E.

Installing the AMCI NET Software

Because many corporate firewalls prevent their users from downloading executable files, the install program exists as a ZIP file from our website. Installation is straight forward.

- 1) Download the software from <http://www.amci.com/product-software.asp>. The link on the page is "AMCI configuration software for all networked products:..."
- 2) Extract the ZIP file to your computer. The resulting file is a simple install file.
- 3) Run the install program. When you do this, the following changes are made to your computer:
 - An AMCI folder is created in your programs folder. (Typically \Program Files\AMCI.)
 - The AMCI NET program is placed in this directory
 - A shortcut to the AMCI NET program is created on the desktop and a program listing is created that will display the program off of the Start Menu.

NOTE  No changes are made to the registry. The AMCI NET program can be easily un-installed by deleting the \Program Files\AMCI directory and shortcuts.

Configure Your Network Interface Card (NIC)

Ideally, the NIC that you will use when configuring an SD31045E is not the NIC that attaches your computer to your corporate network. It is far easier to configure an SD31045E with a stand-alone laptop or when your computer has two NIC's in it, one for the corporate network and one for the SD31045E.

If you only have one NIC, and use to attach your computer to your corporate network, you must disconnect your computer from the corporate network before configuring the SD31045E. DO NOT place a router between your computer and the corporate network so you can try to have access to the network and the SD31045E at the same time. The Network Administrator at AMCI can testify to the fact that “Bad Things” can happen when a rogue DHCP server in engineering starts to offer network information to computers around it. Save yourself and your IT department some headaches and disconnect yourself from your corporate network if you only have one NIC in your computer.

A wireless adapter does count as a network interface and if you have a laptop it may be possible to connect to your corporate network with the wireless interface and use a NIC to configure the SD31045E. It should also be possible to configure the SD31045E over a wireless connection by attaching it to a wireless router. However, this configuration has not yet been tested by AMCI.

The easiest way to check the current settings for your NIC is with the ‘ipconfig’ command.

- ▶ For Windows XP, click on the [Start] button, and click on [Run...]. A dialog box will open. Enter ‘cmd’ on the text line and press [Enter] on the keyboard.
- ▶ For Vista and Windows 7, click on the [Start] button, and type “cmd” in the “Search programs and files” text box. Press [Enter] on the keyboard.

A DOS like terminal will open. Type in ‘ipconfig’, press [Enter] on the keyboard and the computer will return the present Address, Subnet Mask, and Default Gateway for all of your network interfaces. If your present address is 192.168.0.x, where ‘x’ does not equal 50, and your subnet mask is 255.255.255.0, then you are ready to configure the SD31045E. Figure 5.1 shows the output of an ipconfig command that shows the “Local Area Connection 2” interface on the 192.168.0 subnet.

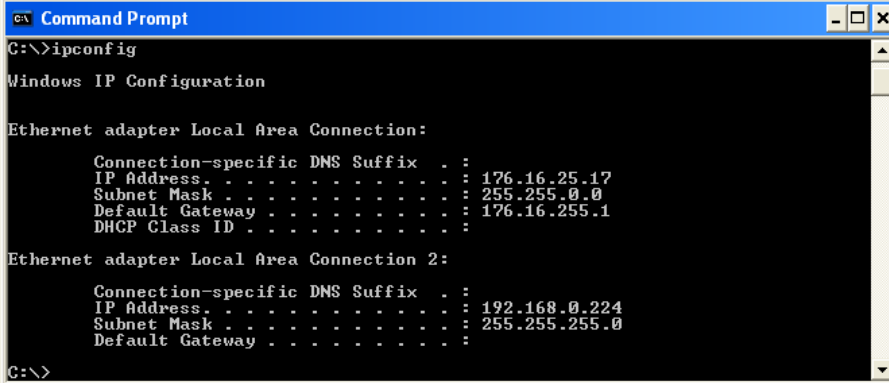

```
Command Prompt
C:\>ipconfig

Windows IP Configuration

Ethernet adapter Local Area Connection:

    Connection-specific DNS Suffix  . : 
    IP Address . . . . . : 176.16.25.17
    Subnet Mask . . . . . : 255.255.0.0
    Default Gateway . . . . . : 176.16.255.1
    DHCP Class ID . . . . . : 

Ethernet adapter Local Area Connection 2:

    Connection-specific DNS Suffix  . : 
    IP Address . . . . . : 192.168.0.224
    Subnet Mask . . . . . : 255.255.255.0
    Default Gateway . . . . . : 
C:\>
```

Figure 5.1 ipconfig Command

Configure Your Network Interface Card (NIC) (continued)

If your present address is not in the 192.168.0.x range, type in 'ncpa.cpl' at the command prompt and hit [Enter] on the keyboard.

- ▶ In XP, this opens the *Network and Dial-up Connections* window. Right click on the appropriate interface and select 'Properties' from the menu. This will open the *Properties* windows for the selected interface. Click on the 'Internet Protocol (TCP/IP)' component and then click on the [Properties] button.
- ▶ For Vista and Windows 7, this opens the *Network Connections* window. Double click on the appropriate interface. In the window that opens, select "Internet Protocol Version 4 (TCP/IP v4)" from the list and then click on the [Properties] button.

Set the address, subnet mask to appropriate values. (192.168.0.1 and 255.255.255.0 will work for an SD31045E with factory default settings.) The default gateway and DNS server settings can be ignored.

Attach the SD31045E

The next step in configuring the SD31045E is attaching it to your computer. Any Cat5, 5e, or 6 cable can be used. You can attach the SD31045E directly to your computer or use a network switch. The SD31045E has an "auto-switch" port which eliminates the need for a crossover cable in direct connect applications.

Once the cables are attached, you can power up the SD31045E.

Using the AMCI Net Configurator

Start the Software

To start the program, click on the desktop icon or navigate from the start button to the program listing and click on the icon there. The program will present a screen similar to figure 5.2 below.

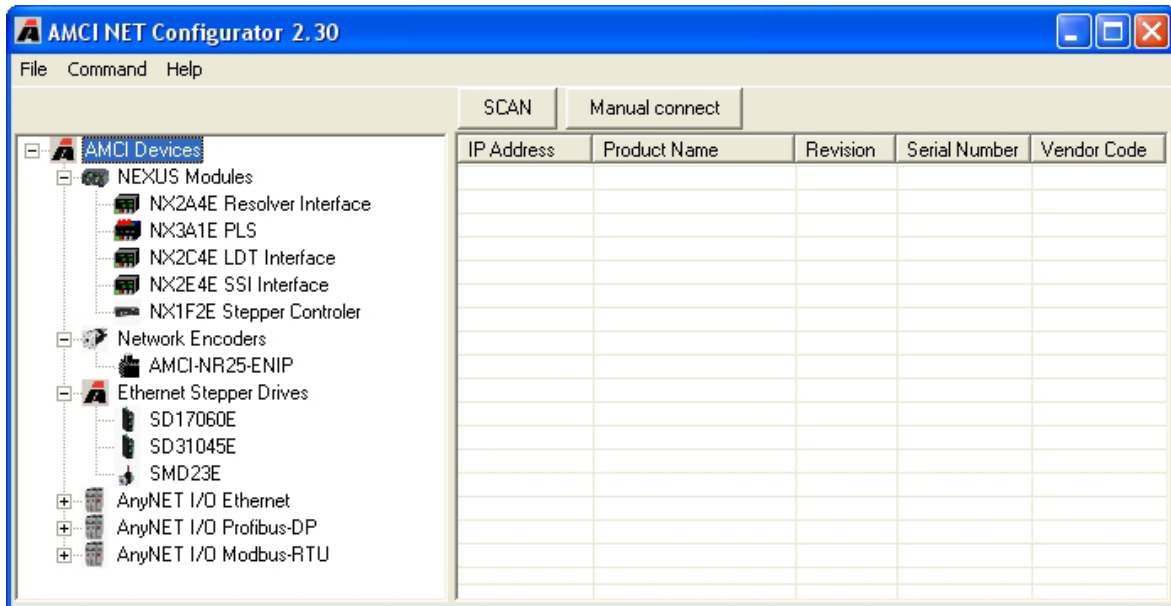

Figure 5.2 AMCI Ethernet Configurator Screen

Using the AMCI NET Software (continued)

Connect to your SD31045E

The first step in configuring your SD31045E is to connect to it. The software will attempt to find your unit when you click on the [Scan] button. If your unit is found, it will appear in the table below the [Scan] button. Simply double click on the IP address of the unit and the configurator screen will open.

The scan feature will not always work. This typically occurs when you have multiple network connections on your computer, (including wireless connections), and the SD31045E is not attached to the port configured as the default gateway. If the scan does not work, you can manually connect to your SD31045E if you know its IP address. Click on the [Manual Connect] button enter the IP address into the *Enter IP Address:* field and press [Connect]. (The factory default address of 192.168.0.50 is the default address of the field.)

Whether you scan or manually connect, you will end up at the screen shown in figure 5.3 below.

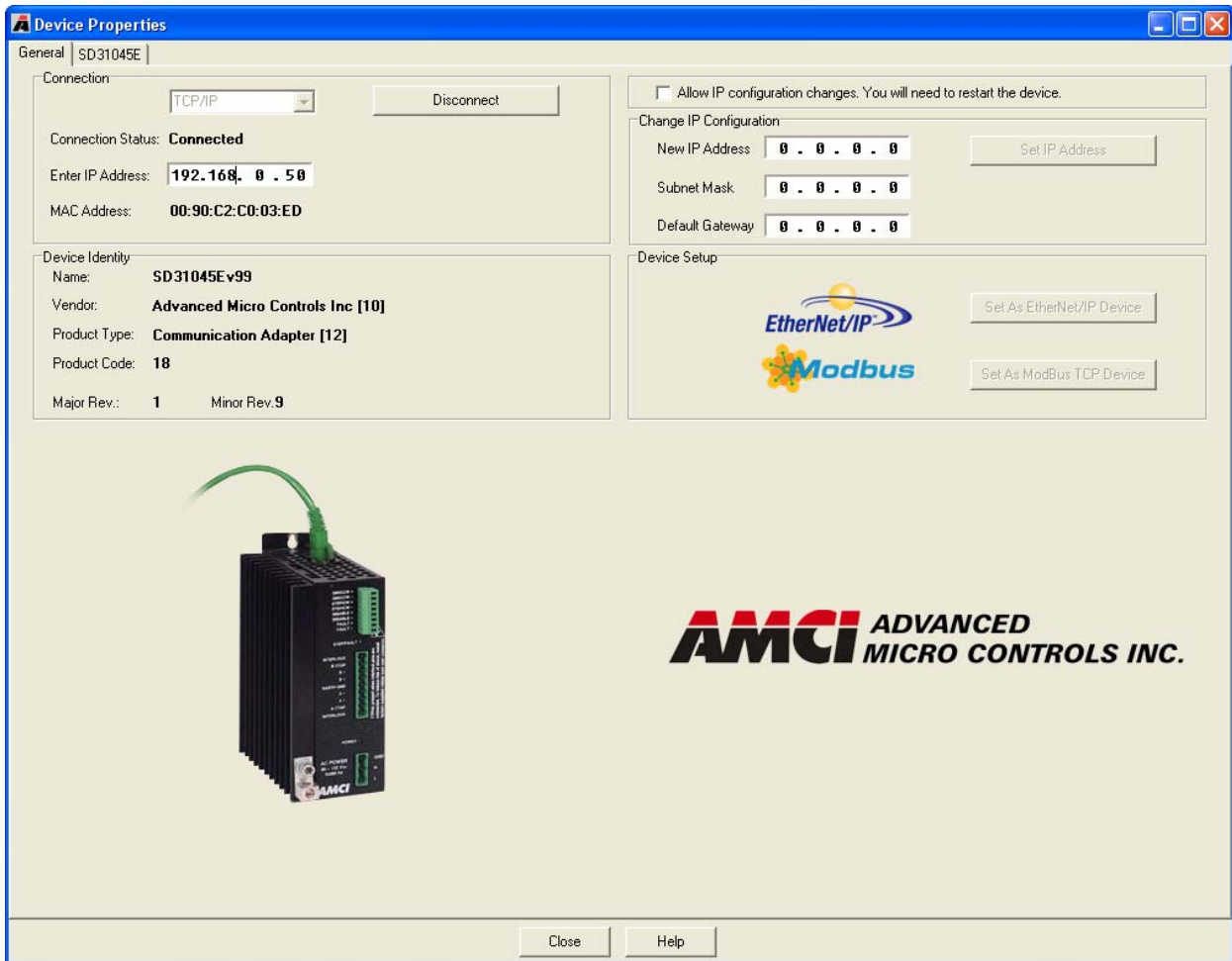

Figure 5.3 SD31045E Scan Results

You start with the General tab showing. The left half of this tab gives you information on the SD31045E that you are connected to. The right half of the window allows you to change the IP address and select the active protocol of the SD31045E. If you want to change this information, you must first allow edits by clicking on the check box at the top entitled “Allow IP configuration changes...”. The name of the SD31045E shows which protocol is active.

Using the AMCI NET Software (continued)

The Meaning of the Product Name

The Name field in on the left hand side of the General tab gives you clues to the configuration of the SD31045E as well as its firmware revision.

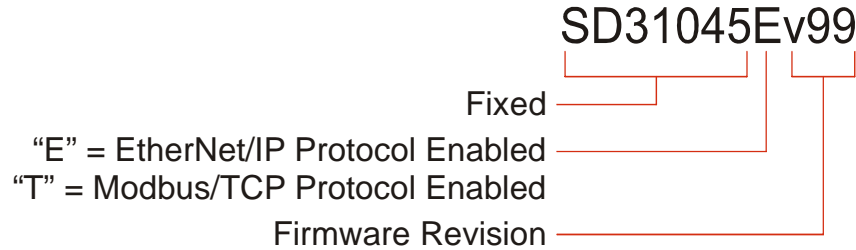

Figure 5.4 Product Name Description

Changing the IP Address

If you are changing the IP address, set the *New IP Address*, *Subnet Mask*, and *Default Gateway* fields to your desired values.

NOTE Leaving the *Default Gateway* set to “0.0.0.0” may cause an error when you write the new address to the SD31045E. AMCI suggests setting the default gateway to the address of your host controller.

Once these values are set, click on the [Set IP Address] button to write these values to the SD31045E. A pop up message will remind you that you must cycle power before the address change takes effect.

Setting Communications Protocol

Simply click on either of the buttons to change the communications protocol used by the SD31045E. When you click on either of the buttons, a pop up message will remind you that you must cycle power before the address change takes effect.

Cycle Power to the SD31045E

The SD31045E will not use the new configuration settings until the next time it powers up.

Testing the New Address

If you changed the address of the SD31045E to a new subnet, then change your NIC’s address to be on the same subnet. Once this is done, apply power to the SD31045E. When the unit finishes its power up sequence press the [Scan] button and re-connect to the unit. Use this step will verify the new address and Network Protocol settings.

Using the AMCI NET Software (continued)

SD31045E Tab

When you connect to the SD31045E, a second tab is added to the window that allows you to read configuration data, and send configuration and command data to the unit.

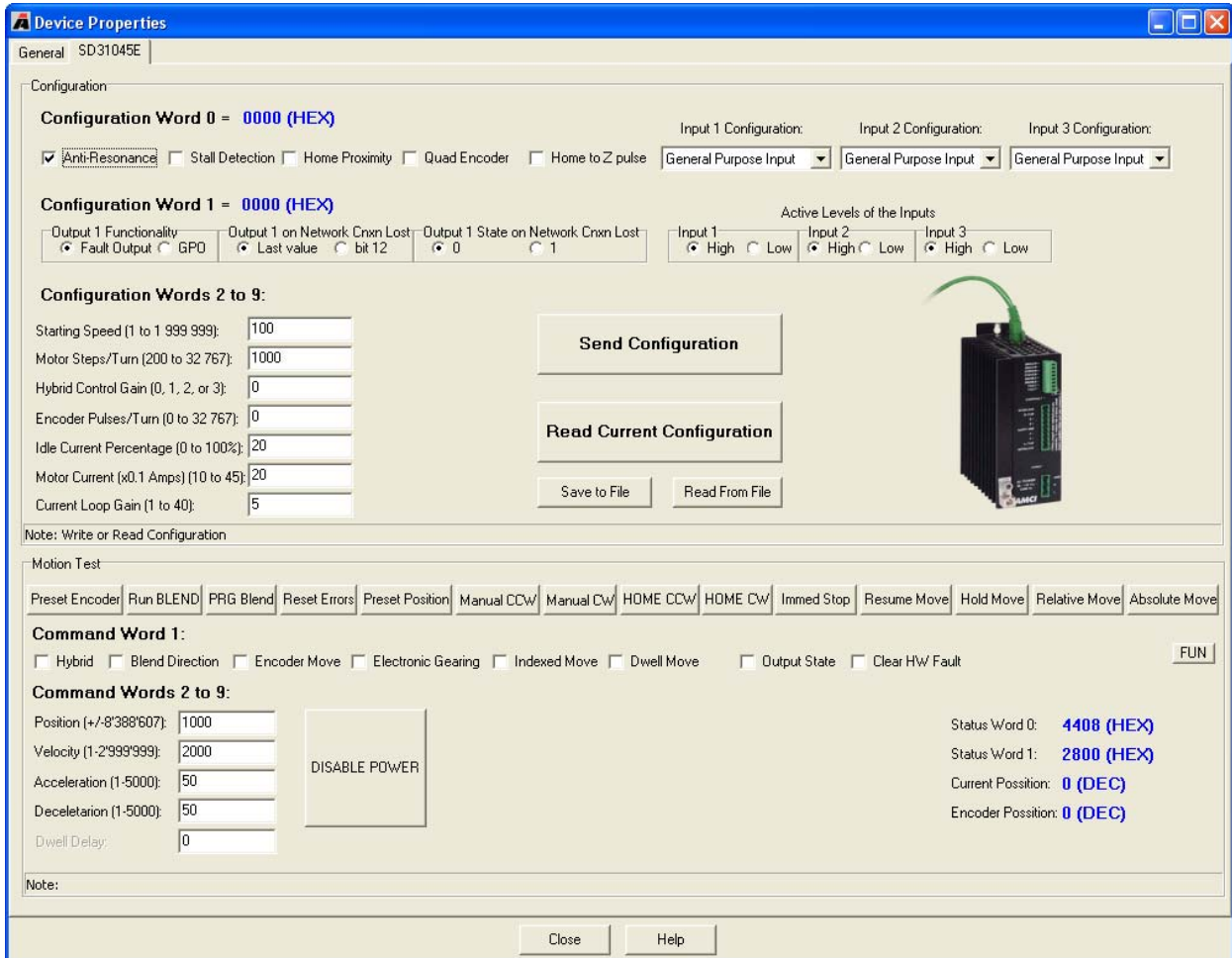

Figure 5.5 Motor Control Tab Screen

- The format of configuration and command data is covered in chapters 8 and 9 of this manual.
- The [Send Configuration] button will write the configuration data SD31045E. Once this is done, the unit will ask you if you also want to save the configuration data to Flash memory. If you select no, the configuration data you just wrote to the SD31045E will be lost when power is removed from the driver. If you select yes, the data is stored in Flash memory and the SD31045E will load the configuration on power up and enter command mode. This eliminates the need to write configuration data to the SD31045E on every power up. You can override the stored configuration by writing new configuration data to the unit at any time. If you do select to write the configuration data to Flash, the software will tell you if the write was successful or not and remind you to cycle power to the driver before continuing.

Using the Ping Command

The easiest way to test the address of the SD31045E when it is in your network is with the “ping” command. Before you can use the command, you have to be sure the SD31045E and your computer are still on the same subnet. For example, if the new address of the SD31045E is 192.168.0.42 and your computer has an address of 192.168.0.1, with a subnet mask of 255.255.255.0, then the two pieces of equipment are on the same subnet. (In this case, the first three numbers of the IP address must match.) If the new address of the SD31045E is 192.168.50.50, then the computer and SD31045E are not on the same subnet and you must go back into the Network Configuration panel and change your adapter’s TCP/IP settings. Refer back to the *Configure Your Network Interface Card (NIC)* section of this chapter, starting on page 54.

When you are sure your computer and the SD31045E are on the same subnet, open the DOS terminal if necessary:

- For Windows XP, click on the [Start] button, and click on [Run...]. A dialog box will open. Enter ‘cmd’ on the text line and press [Enter] on the keyboard.
- For Vista and Windows 7, click on the [Start] button, and type “cmd” in the “Search programs and files” text box. Press [Enter] on the keyboard.

Once the terminal is open, type in ‘ping aaa.bbb.ccc.ddd’ where ‘aaa.bbb.ccc.ddd’ is the new IP address of the SD31045E. The computer will ping the SD31045E and the message “Reply from aaa.bbb.ccc.ddd: bytes=32 time<10ms TTL=128” should appear four times.

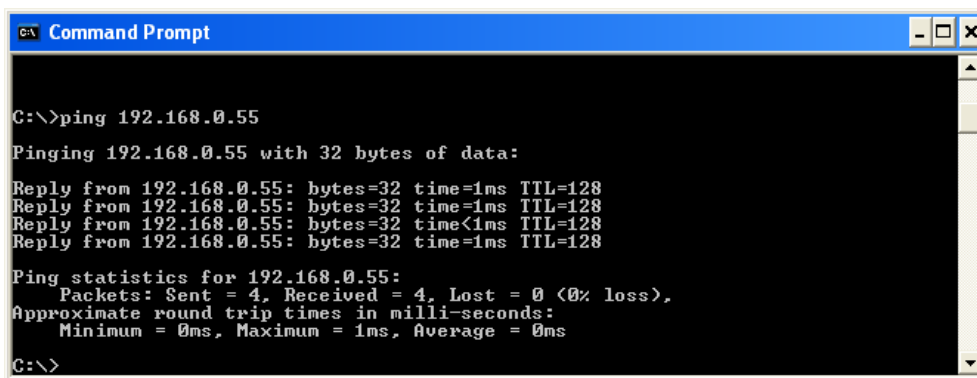

```

C:\>ping 192.168.0.55

Pinging 192.168.0.55 with 32 bytes of data:

Reply from 192.168.0.55: bytes=32 time=1ms TTL=128
Reply from 192.168.0.55: bytes=32 time=1ms TTL=128
Reply from 192.168.0.55: bytes=32 time<1ms TTL=128
Reply from 192.168.0.55: bytes=32 time=1ms TTL=128

Ping statistics for 192.168.0.55:
    Packets: Sent = 4, Received = 4, Lost = 0 (0% loss),
    Approximate round trip times in milli-seconds:
        Minimum = 0ms, Maximum = 1ms, Average = 0ms

C:\>
    
```

Figure 5.6 IP Address Changed Successfully

If the message “Request timed out.” or “Destination host unreachable” appears, then one of four things has occurred:

- You set the new IP address, but have not yet cycled power to the SD31045E
- You did not enter the correct address in the ping command.
- The new IP address of the SD31045E was not set correctly.
- The SD31045E and the computer are not on the same subnet.

Notes

EtherNet/IP CONFIGURATION

The SD31045E requires a host controller to issue motion commands to it. This chapter tells you how to configure Rockwell Automation ControlLogix, CompactLogix, and MicroLogix controllers to act as hosts for the SD31045E. All of these platforms use the EtherNet/IP communications protocol.

RSLogix 5000 Configuration

RSLogix 5000 is used to configure both the ControlLogix and CompactLogix platforms. When using these platforms, you have the option of using a separate Ethernet Bridge module or an Ethernet port built into the processor.

If the Ethernet port is built into processor, the only step you have to take before adding the SD31045E is to create a new project with the correct processor or modify an existing project. Once this is done, the Ethernet port will automatically appear in the Project Tree. If you are using an Ethernet Bridge module, you will have to add it to the I/O Configuration tree before adding the SD31045E to your project.

Configure Bridge Module (As Needed)

The first step is to create a new project or open an existing one. A 1756-L1 processor is used in the screen images below.

- 1) Insert a bridge module into the I/O Configuration tree. As shown in figure 6.1 on the right, right click on the I/O Configuration folder and select "New Module..." in the pop-up menu.
- 2) In the *Select Module Type* windows that opens, select the proper Ethernet Bridge module. (In this example, the 1756-ENET/B.) Click on the [OK] button.
- 3) Enter the following information in the *Module Properties* window that opens. All parameters not listed here are optional. Figure 6.2 shows a completed screen.
 - **Name:** A descriptive name for the Bridge Module.
 - **IP Address:** Must be the address you want for the module, *not* the address you set for the SD31045E.
 - **Slot:** The slot the module will reside in.

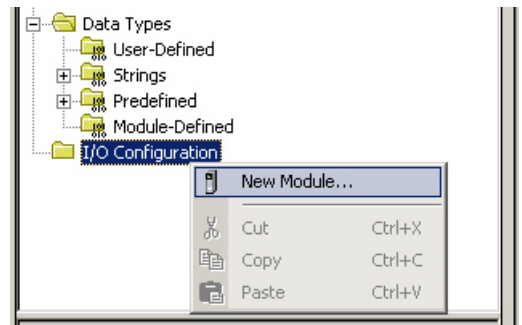

Figure 6.1 Defining a Bridge Module

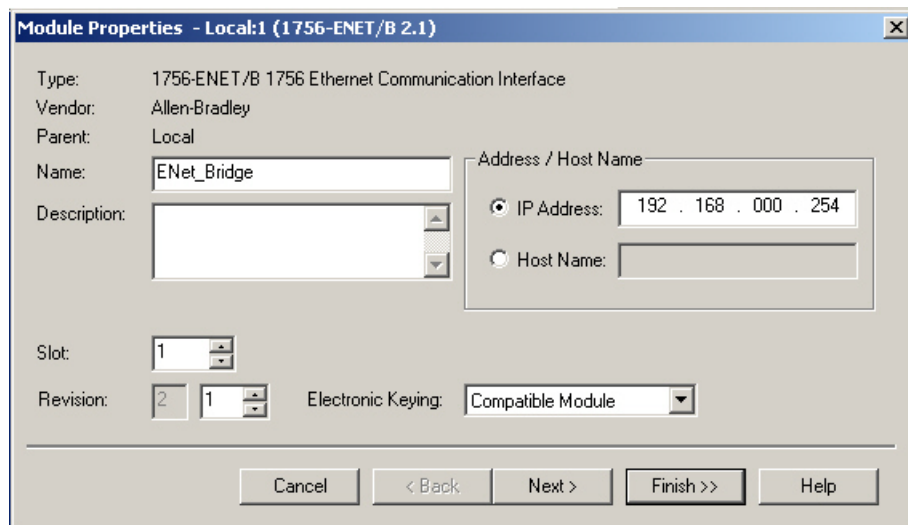

Figure 6.2 Setting Module Properties

- 4) When done, click on [Finish>>] to complete the setup of the Ethernet bridge module.

RSLogix 5000 Configuration (continued)

Configuring a Built-in Ethernet Port (As Needed)

You will still have to set an IP address for the Ethernet Port if the port is built into your processor. Right click on the port name in the I/O Configuration screen and select “Properties”. A Module Properties window similar to the one shown in figure 6.2 will open. In this window you must set an IP Address for the port, *not* the IP address of the SD31045E.

Adding the SD31045E

You can add the SD31045E to the project once the Ethernet port (built-in or bridge module) is configured.

- 1) As shown in figure 6.3 on the right, the Ethernet port will be listed under the I/O Configuration tree. Right click on the port and then click on “New Module...” in the pop-up menu.
- 2) In the resulting window, scroll down the list until you find the entry that has a description of “Generic Ethernet Module”. (Module Type is ETHERNET-MODULE in figure.) Click on the module name to select and then click the [OK] button. A Module Properties window will open.
- 3) Set the following parameters in the Module Properties window. All parameters not listed here are optional. Figure 6.4 shows a completed screen.
 - **Name:** A descriptive name for the SD31045E.
 - **Comm Format:** Data - INT (*MUST be changed from the default Data - DINT.*)
 - **IP Address:** Must be the address you set for the SD31045E. Refer to Chapter 5 starting on page 41 for information on setting the IP Address of the SD31045E.
 - **Input:** Assembly Instance = 100, Size = 10
 - **Output:** Assembly Instance = 150, Size = 10
 - **Configuration:** Assembly Instance = 110, Size = 0

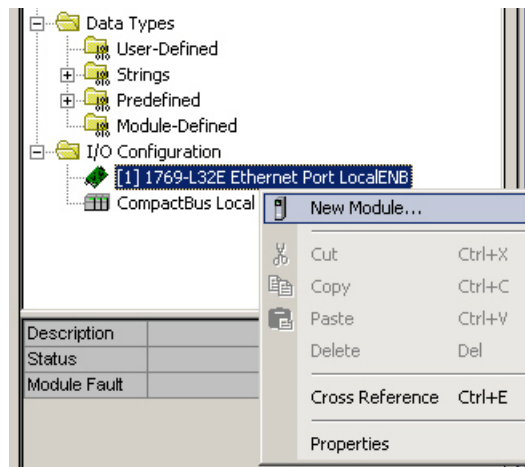

Figure 6.3 Adding an SD31045E

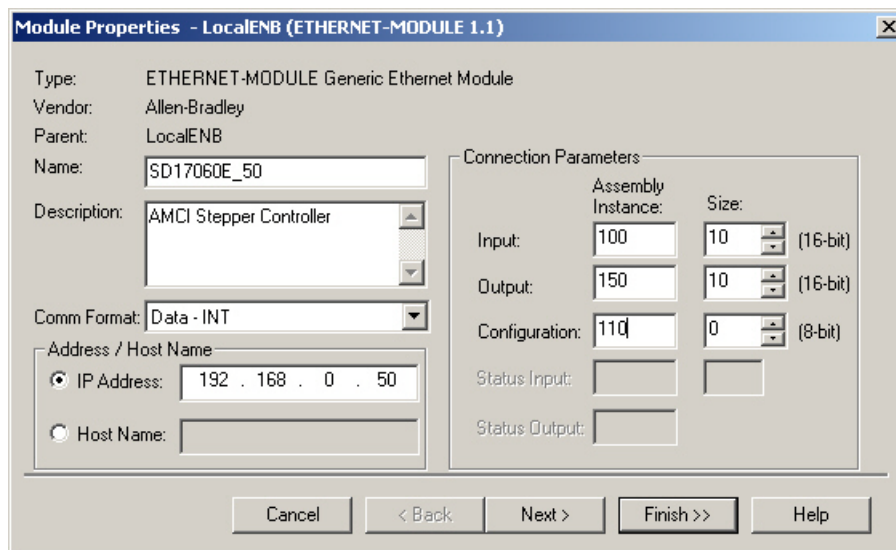

Figure 6.4 Sample SD31045E Configuration Screen

- 4) Click on [Next>]. Set the RPI time as required for your system. The minimum RPI time for the SD31045E is 3 milliseconds. When done, click on [Finish>>] to complete the setup.

RSLogix 5000 Configuration (continued)

Adding the SD31045E (continued)

Error Code 16#0109

The PLC will generate an Error Code 16#0109 when the Comm Format parameter is not changed from its default of “Data-DINT” to “Data-INT”. This is the most common cause of communication failures with the SD31045E.

RSLogix 500 Configuration

Platforms supported by the RSLogix 500 software package require Message Instructions to communicate with the SD31045E. This section uses a MicroLogix 1100 to describe how to configure these instructions.

Two instructions are required to transfer data between the PLC and the SD31045E. One instruction reads data from the SD31045E and the other writes data to the driver. The following table gives the required attributes for the instructions.

	Read Instruction	Write Instruction
Service Type	Read Assembly	Write Assembly
Service Code	E (hex)	10 (hex)
Class	4 (hex)	4 (hex)
Instance	100 (decimal)	150 (decimal)
Attribute	3 (hex)	3 (hex)
Length	20	20

Table 6.1 Message Instruction Attributes

Using Message Instructions in a MicroLogix 1100 PLC

NOTE Only RSLogix 500 version 8.0 or above can be used to configure Message Instructions to communicate with an EtherNet/IP device.

- 1) Create four new data files.
 - An Integer file to contain the data from the SD31045E. This file must have enough elements to contain all of the data read from the driver.
 - An Integer file to contain the data sent to the SD31045E. This file must be large enough to contain all of the data written to the driver.
 - A Message (MG) data file. This file must have at least two elements, one to control the Read Operation and one to control the Write Operation.
 - An Extended Routing Information (RIX) data file. This file is used to store information used by the Message Instructions. This file must have at least two elements, one for the Read Operation and one for the Write Operation.

RSLogix 500 Configuration (continued)**Using Message Instructions in a MicroLogix 1100 PLC (continued)**

- 2) Add the Message Instruction(s) to your Ladder Logic. The following rungs show how you can alternately read data from and write data to your SD31045E.

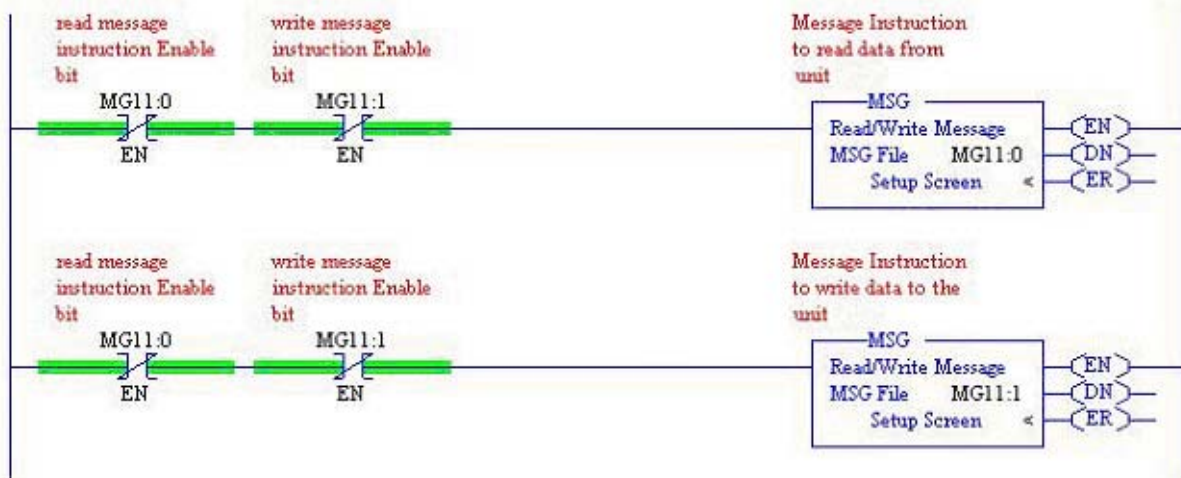

Figure 6.5 Message Instruction Example

- 3) Double Click on *Setup Screen* text inside the Message Instruction. The following window will open. Note that this is the default window and its appearance will change considerably as you progress through these steps.

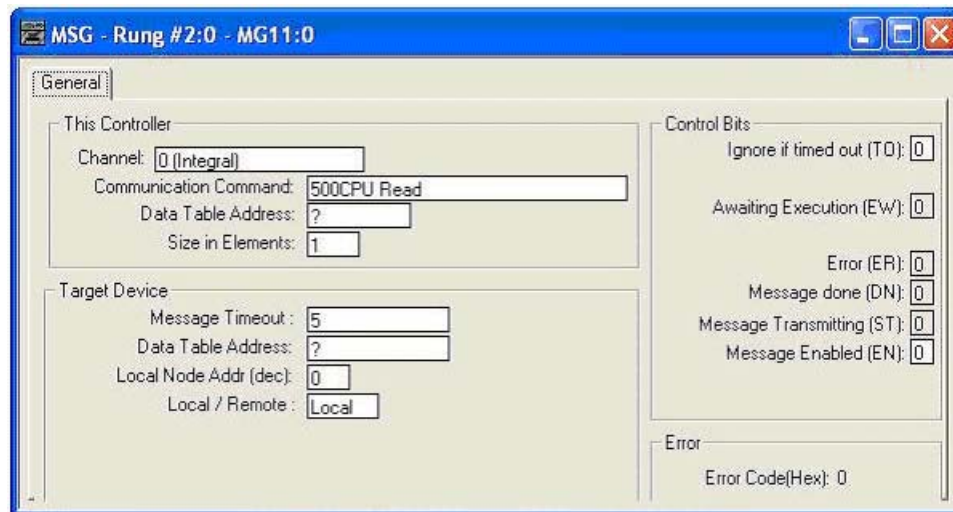

Figure 6.6 Message Instruction Setup Screen

- 4) Double click in the *Channel* field, click on the ▼, select "1 (Integral)", and press Enter.
- 5) Double click in the *Communication Command* field, click on the ▼, select "CIP Generic" and press Enter.
- 6) If the Message Instruction is being used to read data from the SD31045E, enter the integer file where the data will be placed in the *Data Table Address (Received)* field and press enter.
If the Message Instruction is being used to write data to the SD31045E, enter the integer file where the source data will be located in the *Data Table Address (Send)* field and press Enter.
- 7) Enter a value of "20" either in the *Size In Bytes (Receive)* or *Size In Bytes (Send)* field.
- 8) Enter a RIX address in the *Extended Routing Info* field. Please note that each Message Instruction must have its own RIX address.

RSLogix 500 Configuration (continued)

Using Message Instructions in a MicroLogix 1100 PLC (continued)

- 9) Double click in the *Service* field and select “Read Assembly” for a Message Instruction that is being used to read data from the SD31045E, or “Write Assemble” for a Message Instruction that is being used to send data to the SD31045E, and press Enter.
- 10) For *Read* operations, the *Service Code* field will change to “E” (hex). For *Write* operations, the *Service Code* field will change to “10” (hex). For both read and write operations, the *Class* field will change to “4” (hex), and the *Attribute* field will change to “3” (hex).
- 11) For Read operations, enter a value of 100 decimal (64 hex) in the *Instance* field.
For Write operations, enter a value of 150 decimal (96 hex) in the *Instance* field.

The figure below show a typical configuration for Message Instructions being used to read data from a SD31045E. Please note that the Data Table Address (Receive) field may be different in your application.

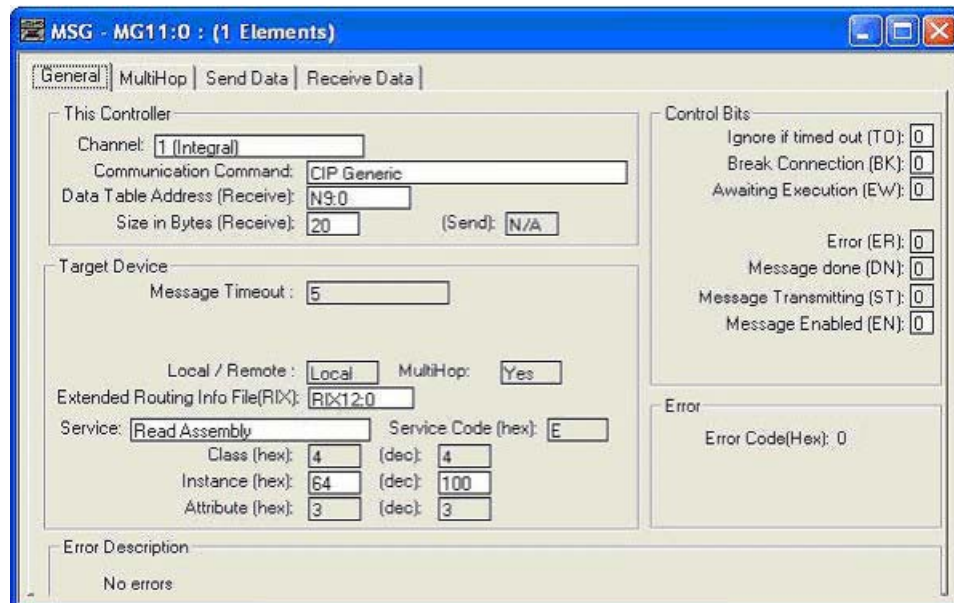

Figure 6.7 Read Message Instruction Setup Screen

RSLogix 500 Configuration (continued)

Using Message Instructions in a MicroLogix 1100 PLC (continued)

The figure below show a typical configuration for Message Instructions being used to write data from a SD31045E. Please note that the Data Table Address (Send) field may be different in your application.

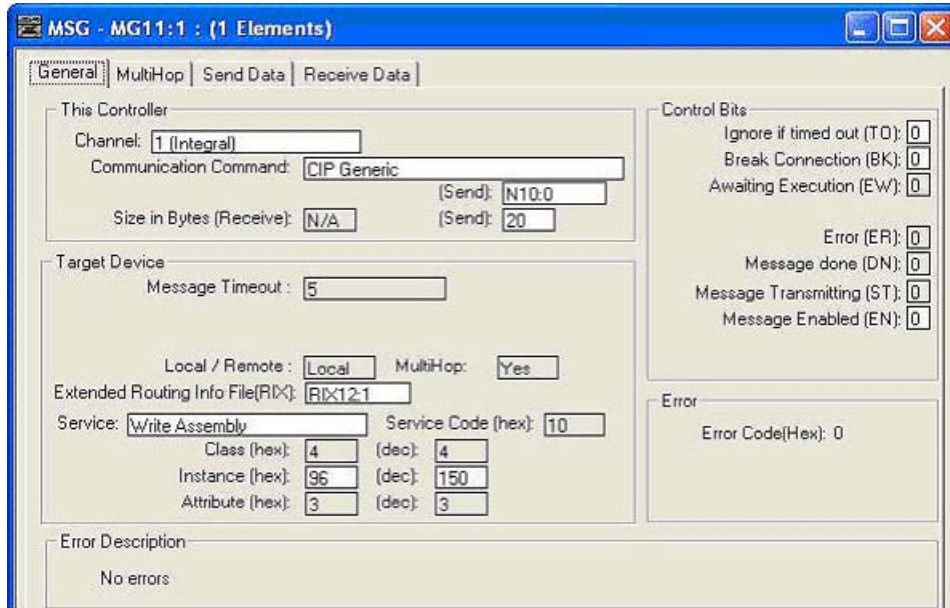

Figure 6.8 Write Message Instruction Setup Screen

Click on the MultiHop tab on the top of the window. As shown in figure 6.9, enter the IP address of the SD31045E and press Enter.

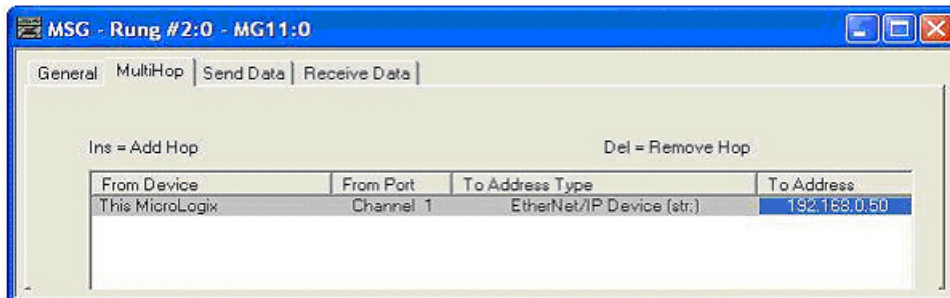

Figure 6.9 Message Instruction MultiHop Settings

After you are finished adding both the read and write message instructions to your program, save and download the program to the PLC.

RSLogix 500 Configuration (continued)

Using Message Instructions in a MicroLogix 1100 PLC (continued)

Troubleshooting

If you are unable to communicate with the SD31045E, the problem may be that the Ethernet port of your MicroLogix 1100 has not been configured. To check this, double click on Channel Configuration in the Project Tree and then select the Channel 1 tab. The following window will open.

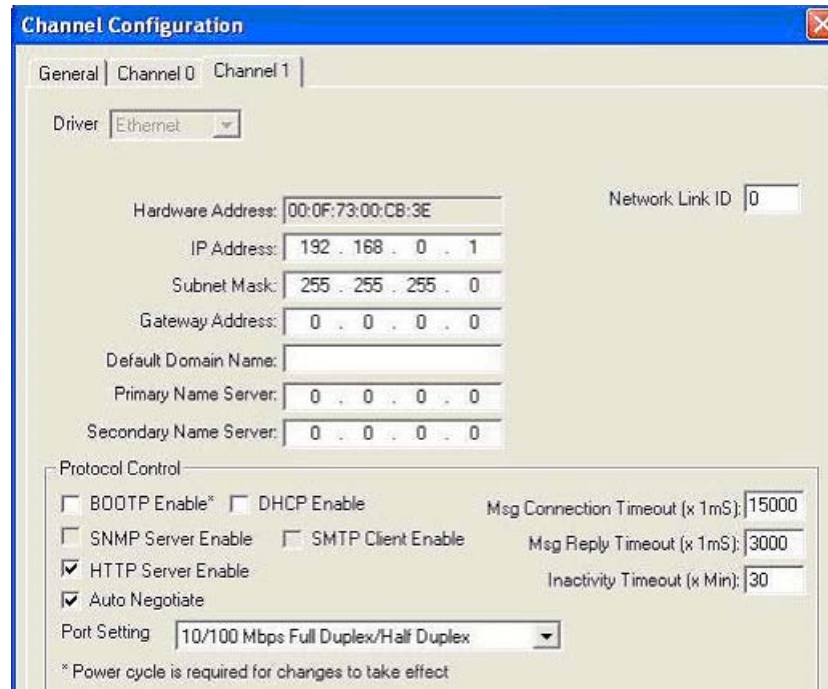

Figure 6.10 MicroLogix Ethernet Configuration Screen

Enter the IP address and Subnet Mask of your system and click on Apply. The Ethernet Port should now be working.

Notes

Modbus/TCP CONFIGURATION

SD31045E Memory Layout

The SD31045E uses ten 16-bit input registers and ten 16-bit output registers to communicate through the Modbus protocol. Figure 7.1 shows how these registers are mapped to the Modbus data reference. The complete specification for the Modbus protocol can be downloaded at <http://www.modbus.org/specs.php>.

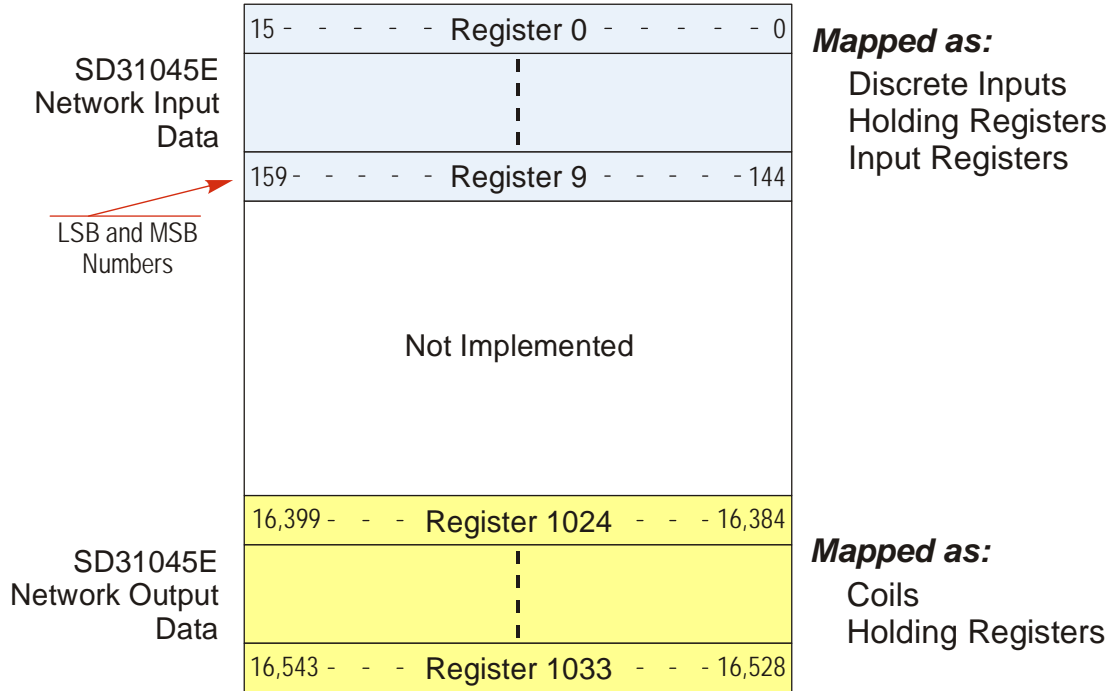

Figure 7.1 Modbus Data Reference Map



Supported Modbus Functions

Function Code	Function Name	SD31045T Register	Addressing method
1	Read Coils	OUTPUT	Bit: Address 16,384 through 16,543
2	Read Discrete Inputs	INPUT	Bit: Address 0 through 159
3	Read Holding Registers	OUTPUT & INPUT	Word: Out Regs. 1024 through 1033 In Regs. 0 through 9
4	Read Input Registers	INPUT	Word: Registers 0 through 9
5	Write Single Coil	OUTPUT	Bit: Address 16,384 through 16,543
6	Write Single Register	OUTPUT	Word: Registers 1024 through 1033
15	Write Multiple Coils	OUTPUT	Bit: Address 16,384 through 16,543
16	Write Multiple Registers	OUTPUT	Word: Registers 1024 through 1033
22	Mask Write Register	OUTPUT	Word: Registers 1024 through 1033
23	Read/Write Registers	INPUT/OUTPUT	Word: Out Regs. 1024 through 1033 In Regs. 0 through 9

Table 7.1 Supported Modbus Functions

Table 7.1 above lists the Modbus functions that are supported by the SD31045E. AMCI supports all of these functions so that you can control the SD31045E as you see fit. However, if you are looking for the easiest way to interface with the SD31045E, then you only need to use the *Read/Write Registers* function, which is function code 23.

NOTE  The SD31045E buffers the data that it sends over the network. If you use the *Read/Write Registers* function to write configuration data to the SD31045E, then the data read with that command will not contain the response to the new configuration data. The response to the new data will be sent with the next data read.

Supported Modbus Exceptions

Code	Name	Description
01	Illegal function	The module does not support the function code in the query
02	Illegal data address	The data address received in the query is outside the initialized memory area
03	Illegal data value	The data in the request is illegal

Table 7.2 Supported Modbus Exceptions

CONFIGURATION MODE DATA FORMAT

This chapter covers the formats of the Network Output Data used to configure the SD31045E as well as the formats of the Network Input Data that contains the responses from the driver. The SD31045E requires ten 16-bit words (20 bytes) for Output Data as well as ten 16-bit words for Input Data.

Modes of Operation

The SD17060E has two operating modes, Configuration Mode and Command Mode. You switch between these modes by changing the state of a single bit in the Network Output Data.

Configuration Mode

Configuration Mode gives you the ability to select the proper configuration for your application without having to set any switches. The SD31045E must be configured on every power up. Additionally, the motor will not receive power until the driver is configured properly.

Command Mode

This mode gives you the ability to program and execute stepper moves, and reset errors when they occur. The SD31045E will always power up in this mode, but a valid configuration must be sent to the SD31045E before it will apply power to the motor or allow you to issue move commands. The command data formats are described in the following chapter.

Multi-Word Format

Many of the hosts that can be used with the SD31045E only support 16 bit integers, which limits the range of values from -32,768 to 32,767 or 0 to 65,535. Many parameters of the SD31045E exceed this range. These parameters are transmitted in two separate words. The table below shows how values are split. Note that negative values are written as negative numbers in both words.

Value	First Word	Second Word
12	0	12
12,345	12	345
1,234,567	1,234	567
-7,654,321	-7,654	-321

Table 8.1 Multi-Word Format Examples

Output Data Format

The correct format for the Network Output Data when the SD31045E is in Configuration Mode is shown below.

EtherNet/IP Word	Modbus/TCP Register	Configuration Data	Range
0	1024	Control Word	See below
1	1025	Configuration Word	See below
2	1026	Starting Speed: Upper Word	Combined value between 1 and 1,999,999 steps/sec.
3	1027	Starting Speed: Lower Word	
4	1028	Motor Steps/Turn	200 to 32,767
5	1029	Hybrid Control Gain	0, 1, 2, or 3
6	1030	Encoder Pulses/Turn	0 to 32,768
7	1031	Idle Current Percentage	0 to 100%
8	1032	Motor Current (X10)	10 to 44, Even numbers only. Represents 1.0 to 4.4 Arms
9	1033	Current Loop Gain	1 to 40

Table 8.2 Network Output Data Format: Configuration Mode

Control Word Format

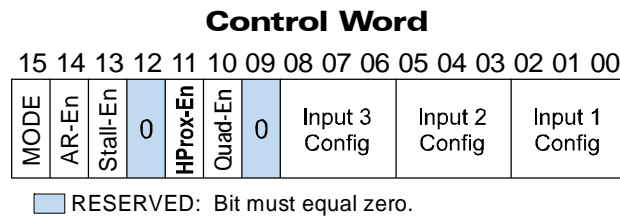

Figure 8.1 Configuration Mode: Control Word Format

- Bit 15: Mode Bit** – “1” for Configuration Mode Programming, “0” for Command Mode Programming. The SD31045E powers up in Command Mode and shows a configuration error. (Hexadecimal value of 6408h.) The SD31045E will not power the motor or accept commands until a valid configuration is written to it.
- Bit 14: Anti-Resonance Enable Bit** – “0” enables the anti-resonance feature of the SD31045E. “1” disables the anti-resonance feature. The Anti-resonance feature will provide smoother operation in most cases. If you are still experiencing resonance problems with this feature enabled, disable this feature and test the machine again.
- Bit 13: Stall Detection Enable Bit** – “0” disables motor stall detection. “1” enables motor stall detection. Only valid when an encoder is used and attached to the motor controlled by the SD31045E. The encoder pulses/turn must also be programmed.
- Bit 11: Home Proximity Bit Enable Bit** – “0” when Home Proximity bit is not used when homing the SD31045E. “1” when the Home Proximity bit is used when homing the SD31045E. Note that this bit is not the Home Proximity Bit, but enables or disables its operation. Do not use the Home Proximity bit if you only want to home to the Home Limit Switch. (Leave this bit equal to “0”.)
- Bit 10: Quadrature Encoder Enable Bit** – “0” when Quadrature Encoder is not used. “1” to enable a Quadrature Encoder. When using a Quadrature Encoder, you must program Inputs 1 and 2 to accept quadrature signals and enter a value in Word 6 for the Encoder Pulses/Turn parameter in addition to setting this bit.
- Bit 9: Reserved** – Must equal zero.

Configuration Mode - Output Data Format (continued)

Control Word Format (continued)

Bits 8-6: Input 3 Configuration Bits – See Table Below

Bits 5-3: Input 2 Configuration Bits – See Table Below

Bits 2-0: Input 1 Configuration Bits – See Table Below

Bits			Function	Available On
8	7	6		
5	4	3		
2	1	0		
0	0	0	General Purpose Input	All Inputs - The input is not used in any functions of the SD31045E, but it's status is reported in the Network Data. This allows the input to be used as a discrete DC input to your controller.
0	0	1	CW Limit	All Inputs
0	1	0	CCW Limit	All Inputs
0	1	1	Start Indexed Move	All Inputs
0	1	1	Start Indexed Move / Capture Encoder Value	Input 3 when Inputs 1 & 2 are configured as quadrature encoder inputs. The encoder position value is captured whenever Input 3 transitions. An inactive-to-active state transition will also trigger an Indexed Move if one is pending in the SD31045E.
1	0	0	Stop Manual or Registration Move	All Inputs
1	0	0	Stop Manual or Registration Move & Capture Encoder Value	Input 3 when Inputs 1 & 2 are configured as quadrature encoder inputs. The encoder position value is captured when Input 3 triggers a controlled stop to a Manual or Registration move.
1	0	1	Emergency Stop	All Inputs
1	1	0	Home	All Inputs when using discrete sensors. Input 3 only when using quadrature encoder. Use this configuration value when homing to the Z-Pulse of an encoder.
1	1	1	Quadrature Encoder Input	Inputs 1 and 2 only. Input 1 is channel A. Input 2 is channel B.

Table 8.3 Configuration Mode: Control Word Format

NOTE When using a quadrature encoder, you must set bit 10, the Quadrature Encoder Enable Bit, in addition to programming the inputs to accept quadrature signals. You must also program the Encoder Pulses/Turn parameter in configuration word 6.



Configuration Mode - Output Data Format (continued)**Configuration Word Format**

Figure 8.2 Configuration Mode: Config Word Format

Bit 15: Driver Enable Bit – This bit is ignored with firmware revision 8.9 and above, which is included in serial numbers D04120070 and above. For drivers with lower firmware revisions, set to “0” to disable the motor driver circuitry. Set to “1” to enable the motor driver circuitry. When the motor driver is disabled, all voltage is removed from the motor. A 0→1 transition is required to enable the motor driver on every power up. This is required while a valid configuration is written to the SD31045E or after it and before entering Command Mode.

NOTE  The SD31045E motor driver must be enabled before switching to Command Mode. It will not be possible to enable or disable the driver while in Command Mode if this step is ignored.

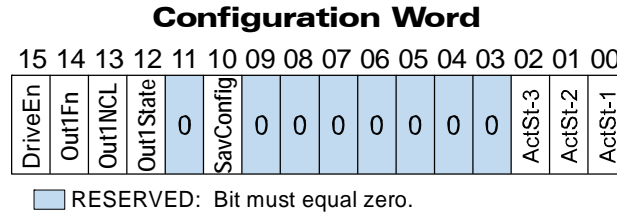
Bit 14: Output 1 Functionality Bit – “0” configures Output 1 to be a Fault Output. The output will conduct current until a fault occurs. “1” configures Output 1 to be a general purpose output whose state is determined by a bit in the Command Mode Network Output Data. This output is in an ON state when power is applied to the SD31045E and it has not yet been configured.

Bit 13: Output 1 on Network Connection Lost Bit – “0” will keep Output 1 at its last value. “1” will set the state of Output 1 to the value specified in Bit 12 of this word.

Bit 12: Output 1 State on Network Connection Lost Bit – When bit 13 of this word is set, Output 1 will be set to the state of this bit if the network connection is lost.

Bit 11: Reserved Bit – Must equal zero.

Bit 10: Save Configuration – An SD31045E will store its configuration data to flash memory when this bit makes a 0 → 1 transition. The validity of the configuration data is checked before being written. If the data is not correct, the transition on this bit is ignored. Once the write to flash is completed, the SD31045E will write 16#AAAA into the last word of the Network Input Data and the Status LED will start flashing green if the write was successful, or the SD31045E will write 16#EEEE into the last word of the Network Input Data and the Status LED will start flashing red if the write was unsuccessful. Once the SD31045E issues its response to the Save Configuration command, it stops responding to commands and you must cycle power to the unit. This design decision prevents the SD31045E from responding to constant save commands from the host controller. The endurance of the Flash memory is a minimum of 10,000 write cycles.

Bits 9 - 3: Reserved Bits – Must equal zero.

Configuration Mode - Output Data Format (continued)

Configuration Word Format (continued)

- Bit 2: Input 3 Active Level Bit** – Determines the active state of Input 3. Set to “0” if your sensor has Normally Closed (NC) contacts and the input is active when there is no current flow through it. Set to “1” if your sensor has Normally Open (NO) contacts and current flows through the input when it is active.
- Bit 1: Input 2 Active Level Bit** – Determines the active state of Input 2. Set to “0” if your sensor has Normally Closed (NC) contacts and the input is active when there is no current flow through it. Set to “1” if your sensor has Normally Open (NO) contacts and current flows through the input when it is active.
- Bit 0: Input 1 Active Level Bit** – Determines the active state of Input 1. Set to “0” if your sensor has Normally Closed (NC) contacts and the input is active when there is no current flow through it. Set to “1” if your sensor has Normally Open (NO) contacts and current flows through the input when it is active.

NOTE  The SD31045E does not report the state of the inputs when they are configured as encoder inputs (ABZ). The driver reports the state of the *Active Level Bit* for the input.

Notes on Other Configuration Words

- Information on the *Multi-Word Format* used when programming the Starting Speed can be found on page 71.
- Hybrid Control Gain controls the “stiffness” of the shaft at zero speed when using the Hybrid Control feature. With a higher gain setting, the SD31045E will increase the motor current more quickly to compensate for shaft loading.
- Changes to the Idle Current only take effect at the *end of the first move after re-configuration*.
- *Current Loop Gain* settings for all AMCI motors can be found on page 36.

Input Data Format

The correct format for the Network Input Data when the SD31045E is in Configuration Mode is shown below.

EtherNet/IP Word	Modbus/TCP Register	Configuration Data
0	0	Control Word
1	1	Mirror of Output Data Config Word
2	2	Mirror of Starting Speed: Upper Word
3	3	Mirror of Starting Speed: Lower Word
4	4	Mirror of Motor Steps/Turn
5	5	Mirror of Hybrid Control Gain
6	6	Mirror of Encoder Pulses/Turn
7	7	Mirror of Idle Current Percentage
8	8	Mirror of Motor Current (X10)
9	9	Mirror of Current Loop Gain

Table 8.4 Network Input Data Format: Configuration Mode

Control Word Format (Word 0)

When the Configuration data is valid and accepted, this word mirrors the value of the Control Word written to the SD31045E. When the SD31045E is not configured, or the data written to it is invalid, then this word has the same format of Status Word 1 when the SD31045E is in Command Mode. This format is explained in the [Status Word 1 Format](#) section starting on page 90. On power up, the value of this word will be 6408h.



When in Configuration Mode, bit 13 of word 0 is set to “1” when stall detection is enabled. When in Command Mode, bit 13 of word 0 is set to “1” when there is a configuration error. When using the state of bit 13 of word 0 in your logic, always include the state of bit 15 of word 0 to assure that you are only acting on the bit when in the proper mode.

Invalid Configurations

The following configurations are invalid:

- 1) Setting any of the reserved bits in the configuration words.
- 2) Setting any parameter to a value outside of its valid range. This includes setting the Lower Word of the Starting Speed to a value greater than 999.
- 3) You configure two or more inputs to have the same function, such as two CW Limit Switches.
- 4) You configure the SD31045E to use an encoder, but you do not configure Inputs 1 and 2 as Quadrature Encoder Inputs.
- 5) You configure the SD31045E to use an encoder, but you do not set the Encoder Pulses/Turn value in word 6.
- 6) Setting the Stall Detection Enable Bit without configuring the SD31045E to use an encoder.

COMMAND MODE DATA FORMAT

This chapter covers the formats of the Network Output Data used to command the SD31045E as well as the formats of the Network Input Data that contains the responses from the driver. The SD31045E requires ten 16-bit words (20 bytes) for Output Data as well as ten 16-bit words for Input Data.

Multi-Word Format

Many of the hosts that can be used with the SD31045E only support 16 bit integers, which limits the range of values from -32,768 to 32,767 or 0 to 65,535. Many parameters of the SD31045E exceed this range. These parameters are transmitted in two separate words. The table below shows how values are split. Note that negative values are written as negative numbers in both words.

Value	First Word	Second Word
12	0	12
12,345	12	345
1,234,567	1,234	567
-7,654,321	-7,654	-321

Figure 9.1 Multi-Word Format Examples

Command Bits Must Transition

Commands are only accepted when the command bit makes a 0→1 transition. The easiest way to do this is to write a value of zero into the Command Bits MSW before writing the next command.

This condition also applies when switching from Configuration Mode to Command Mode. If a bit is set in the Control Word (Word 0) while in Configuration Mode and you switch to Command Mode with the same bit set, the command will not occur because the bit must transition between writes to the unit.

Output Data Format

The following table shows the format of the output network data words when writing command data to the SD31045E.

EtherNet/IP Word	Modbus/TCP Register	Function
0	1024	Command Bits MSW
1	1025	Command Bits LSW
2	1026	Command Parameters <i>Word meaning depends on the command set to the SD31045E</i>
3	1027	
4	1028	
5	1029	
6	1030	
7	1031	
8	1032	
9	1033	

Figure 9.2 Command Data Format

Command Bits MSW

Command Bits MSW															
15	14	13	12	11	10	09	08	07	06	05	04	03	02	01	00
MODE	PrstEnc	RunAMv	PrgAMS	PrgAMv	ClrErr	PrstPos	ManMv-	ManMv+	Home-	Home+	I-Stop	ResmMv	HoldMv	RelMv	AbsMv

Figure 9.3 Command Bits MSW Format

- Bit 15: Mode Bit** – “1” for Configuration Mode Programming “0” for Command Mode Programming. The SD31045E powers up in Command Mode and shows a configuration error. (Hexadecimal value of 6408h.) The SD31045E will not power the motor or accept commands until a valid configuration is written to it.
- Bit 14: Preset Encoder Bit** – When set to “1” the SD31045E will preset the Encoder Position to the value stored in Output Words 2 and 3.
- Bit 13: Run Assembled Move** – When set to “1” the SD31045E will run the Assembled Move already stored in memory.
- **Assembled Move Type – Command Bits LSW, Bit 9:** This bit determines the type of move that is run. When this bit equals “0”, a Blend Move is run. When this bit equals “1”, a Dwell Move is run. When starting a Dwell Move, the Dwell Time is programmed in word 9 of the Command Data. The value is programmed in milliseconds and can range from 0 to 65,536.
 - **Blend Move Direction – Command Bits LSW, Bit 4:** This bit is used to determine the direction that the Blend Move will be run in. When this bit equals “0”, the Blend Move runs in the clockwise direction. When this bit equals “1”, the Blend Move is run in the counter-clockwise direction.
- Bits 11 & 12: Program Move & Program Move Segment Bits** – These bits are used to program the segments of an Assembled Move before the move can be run. Their use is explained in the [Assembled Move Programming](#) section of this manual starting on page 31.
- Bit 10: Reset Errors** – When set to “1” the SD31045E will clear all existing errors, reset the Move Complete bit, and attempt to use the present data to run a new command.
- Bit 9: Preset Motor Position Bit** – When set to “1” the SD31045E will preset the Motor Position to the value stored in Output Words 2 and 3 and reset the Move Complete bit in the Network Input Data.
- Bit 8: CCW Manual Move** – When set to “1” the SD31045E will run a Manual Move in the counter-clockwise direction. The full explanation of a [Manual Move](#) can be found starting on page 23.
- **Run Registration Move – Command Bits LSW, Bit 7:** When this bit equals “0”, and a Manual Move command is issued, it will run as a standard Manual Move. When this bit equals “1” and a Manual Move command is issued, the move will run as a Registration Move.
 - **Enable Electronic Gearing Mode – Command Bits LSW, Bit 6:** When this bit equals “1” the SD31045E will switch its operation to [Electronic Gearing](#) mode as described on page 34. While in this mode, the two Manual Move bits are used to enable motor motion. One of these two bits must equal “1” before the motor will follow a change in encoder position.
- Bit 7: CW Manual Move** – When set to “1” the SD31045E will run a Manual Move in the clockwise direction. The full explanation of a [Manual Move](#) can be found starting on page 23.
- **Run Registration Move – Command Bits LSW, Bit 7:** When this bit equals “0”, and a Manual Move command is issued, it will run as a standard Manual Move. When this bit equals “1” and a Manual Move command is issued, the move will run as a Registration Move.
 - **Enable Electronic Gearing Mode – Command Bits LSW, Bit 6:** When this bit equals “1” the SD31045E will switch its operation to [Electronic Gearing](#) mode as described on page 34. While in this mode, the two Manual Move bits are used to enable motor motion. One of these two bits must equal “1” before the motor will follow a change in encoder position.

COMMAND MODE DATA FORMAT

Command Bits MSW (continued)

- Bit 6: Find Home CCW** – When set to “1” the SD31045E will attempt to move to the Home Limit Switch in the counter-clockwise direction. A full explanation of homing can be found in the *Defining Home Position* section starting on page 20.
- Bit 5: Find Home CW** – When set to “1” the SD31045E will attempt to move to the Home Limit Switch in the clockwise direction. A full explanation of homing can be found in the *Defining Home Position* section starting on page 20.
- Bit 4: Immediate Stop Bit** – When set to “1” the SD31045E will stop all motion without deceleration. The Motor Position value will become invalid if this bit is set during a move. Setting this bit when a move is not in progress will not cause the Motor Position to become invalid.
- Bit 3: Resume Move Bit** – Set to “1” to resume a move that you previously placed in a hold state. Use of the Resume Move and Hold Move bits can be found in the *Controlling Moves In Progress* section of this manual starting on page 33. Note that a move in its hold state does not need to be resumed. The move is automatically cancelled if another move is started in its place.
- Bit 2: Hold Move Bit** – Set to “1” to hold a move. The move will decelerate to its programmed Starting Speed and stop. The move can be completed by using the Resume Move bit. Use of the Hold Move and Resume Move bits can be found in the *Controlling Moves In Progress* section of this manual starting on page 33.
- Bit 1: Relative Move Bit** – Set to “1” to perform a Relative Move using the data in the rest of the Command Data. The full explanation of a *Relative Move* can be found starting on page 25.
- Bit 0: Absolute Move Bit** – Set to “1” to perform an Absolute Move using the data in the rest of the Command Data. The full explanation of an *Absolute Move* can be found starting on page 26.

Command Bits LSW

Command Bits LSW

15	14	13	12	11	10	09	08	07	06	05	04	03	02	01	00
DriveEn	0	GPOut1	0	HPprox	ClrDrvFlt	AMType	IndxMv	RunReg	EGMode	SVAssy or KEY2	AMvDir	HyCtrl	EncMv	KEY1	KEY0

Figure 9.4 Command Bits LSW Format

- Bit 15: Driver Enable Bit** – “0” to disable the motor current, “1” to enable motor current. A valid configuration must be written to the SD31045E before the driver can be enabled.
- Bit 14: Reserved** – Must equal “0”.
- Bit 13: General Purpose Output State Bit** – When the output is configured as a general purpose output point instead of the Fault Output, this bit controls the state of the output. When this bit equals a “1”, the output is on and conducts current.
- Bit 12: Reserved** – Must equal “0”.
- Bit 11: Home Proximity Bit** – When the SD31045E is configured to use the Home Proximity bit, the SD31045E will ignore the state of the Home Input as long as this bit equals “0”. This bit must equal “1” before a transition on the Home Input can be used to home the machine. Further information on using the Home Proximity bit can be found in the *Find Home CW & Find Home CCW Commands* section starting on page 20.
- Bit 10: Clear Driver Fault** – If this bit is set when a Reset Errors Command is issued, (Command Bits MSW Bit 10) the SD31045E will attempt to clear driver errors such as a missing interlock jumper or motor short fault. Note that the driver must be disabled (Command Bits LSW, Bit 15 = 0), when using this command.

Command Bits LSW (continued)

- Bit 9: Assembled Move Type** – When this bit equals “0”, a Blend Move is started when the Run Assembled Move bit, (Command Word 1, Bit 13) makes a 0 → 1 transition. When this bit equals “1”, a Dwell Move is started on the transition. The direction of a Blend Move is controlled by the Blend Move Direction bit, (Command Bits LSW, Bit 4). In a Dwell Move, the Dwell Time between segments is programmed in Word 9 of the command data.
- Bit 8: Run As An Indexed Move** – If this bit is set when a move command is issued, the SD31045E will not run the move immediately, but will instead wait for an inactive-to-active transition on an input configured as a *Start Indexer Move* input.
- Bit 7: Run Registration Move** – When this bit equals “0”, and a Manual Move command is issued, it will run as a standard Manual Move. When this bit equals “1” and a Manual Move command is issued, the move will run as a Registration Move.
- Bit 6: Enable Electronic Gearing Mode** – Set to “1” to put the SD31045E in Electronic Gearing mode. Set to “0” for normal operation. A full description of Electronic Gearing mode starts on page 23.
- Bit 5: Save Assembled Move** - Available in units with firmware 8.9+, Serial #: D04120070+. Set this bit to save programmed blend move data. This bit is only acted upon when the Program Move bit (Command Bits MSW, Bit 11) makes a 1 → 0 transition as explained in the *Assembled Move Programming* section of this manual starting on page 31.
- Motor Current Key2** – Available in units with firmware 6.9-, Serial #: D04120069-. See the description below.
- Bit 4: Blend Move Direction** – When you command a Blend Move to run, this bit determines the direction of rotation. Set to “0” for a clockwise Blend Move, ‘1’ for a counter-clockwise Blend Move.
- Bit 3: Hybrid Control Enable** – Set to “0” to operate the SD31045E as a standard stepper system. Set to “1” to enable Hybrid Control. *Hybrid Control* is explained starting on page 35.
- Bit 2: Encoder Move** – Set to “1” when you command an Absolute or Relative move to cause the move distance to be based on the encoder position, not on the motor position. Set to “0” for a standard Relative or Absolute move based on motor position. A full description of Encoder Moves starts on page 19.
- Bit 1: Motor Current Key1** – See the description below.
- Bit 0: Motor Current Key0** – See the description below.

Description of Motor Current Keys

With the exceptions of the \pm Registration Move commands and Run Assembled Move command, it is possible to change the motor current “on the fly” while in Command Mode. To do this, place the new motor current in Word 8 and set the key bits as shown below.

- Control Word 2: Bit 5 – “1” *Note: This bit is only used by units with a firmware revision of 6.9 or less.*
- Control Word 2: Bit 1 – “0”
- Control Word 2: Bit 0 – “1”

This feature does not work with \pm Registration Move commands because Words 8 and 9 are used to store the registration distance. This feature does not work with the Run Assembled Move command because motor current is set when you program the move segment. For all other commands, the SD31045E will respond by changing the motor current and writing the new value into the Network Input Data, Word 8. Once the motor current has been set, reset the key bits to all zeros to prevent further changes to the motor current. The motor current can be changed at any time, including during a move.

NOTE  Setting the motor current outside of the range of 1.0 to 4.4 amps does not force a command error. The new value will be ignored by the SD31045E and it will use the motor current value programmed while in Configuration Mode.

COMMAND MODE DATA FORMAT

Command Blocks

The following section lists the output data format for the sixteen different commands.

Absolute Move

EtherNet/IP Word	Modbus/TCP Register	Function	Units	Range
0	1024	<i>Command Bits MSW</i>		16#0001
1	1025	<i>Command Bits LSW</i>		See pg. 79
2	1026	Abs. Target Position: Upper Word	Steps	Combined value between -8,388,608 and +8,388,607
3	1027	Abs. Target Position: Lower Word		
4	1028	Programmed Speed: Upper Word	Steps/Second	Combined value between the Configured Starting Speed and 2,999,999
5	1029	Programmed Speed: Lower Word		
6	1030	Acceleration	Steps/ms/sec	1 to 5000
7	1031	Deceleration	Steps/ms/sec	1 to 5000
8	1032	Motor Current	0.1 A	10 to 44, even numbers only. Represents 1.0 to 4.4 ARMS
9	1033	Acceleration Jerk		0 to 5000

Table 9.1 Absolute Move Command Block

Relative Move

EtherNet/IP Word	Modbus/TCP Register	Function	Units	Range
0	1024	<i>Command Bits MSW</i>		16#0002
1	1025	<i>Command Bits LSW</i>		See pg. 79
2	1026	Rel. Target Position: Upper Word	Steps	Combined value between -8,388,608 and +8,388,607
3	1027	Rel. Target Position: Lower Word		
4	1028	Programmed Speed: Upper Word	Steps/Second	Combined value between the Configured Starting Speed and 2,999,999
5	1029	Programmed Speed: Lower Word		
6	1030	Acceleration	Steps/ms/sec	1 to 5000
7	1031	Deceleration	Steps/ms/sec	1 to 5000
8	1032	Motor Current	0.1 A	10 to 44, even numbers only. Represents 1.0 to 4.4 ARMS
9	1033	Acceleration Jerk		0 to 5000

Table 9.2 Relative Move Command Block

Command Blocks (continued)**Hold Move**

EtherNet/IP Word	Modbus/TCP Register	Function	Units	Range
0	1024	<i>Command Bits MSW</i>		16#0004
1	1025	<i>Command Bits LSW</i>		See pg. 79
2	1026	Unused		See Note Below
3	1027	Unused		See Note Below
4	1028	Unused		See Note Below
5	1029	Unused		See Note Below
6	1030	Unused		See Note Below
7	1031	Unused		See Note Below
8	1032	Unused		See Note Below
9	1033	Unused		See Note Below

Table 9.3 Hold Move Command Block

Unused words are ignored by the SD31045E and can be any value, including parameter values in the previous command.

Resume Move

EtherNet/IP Word	Modbus/TCP Register	Function	Units	Range
0	1024	<i>Command Bits MSW</i>		16#0008
1	1025	<i>Command Bits LSW</i>		See pg. 79
2	1026	Unused		See Note Below
3	1027	Unused		See Note Below
4	1028	Programmed Speed: Upper Word	Steps/Second	Combined value between the Configured Starting Speed and 2,999,999
5	1029	Programmed Speed: Lower Word		
6	1030	Acceleration	Steps/ms/sec	1 to 5000
7	1031	Deceleration	Steps/ms/sec	1 to 5000
8	1032	Motor Current	0.1 A	10 to 44, even numbers only. Represents 1.0 to 4.4 ARMS
9	1033	Acceleration Jerk		0 to 5000

Table 9.4 Resume Move Command Block

Unused words are ignored by the SD31045E and can be any value, including parameter values in the previous command. This is typically the case when resuming a move, the words are listed as “Unused” to highlight that the target position of a held move cannot be changed when the move is resumed.

Command Blocks (continued)

Immediate Stop

EtherNet/IP Word	Modbus/TCP Register	Function	Units	Range
0	1024	<i>Command Bits MSW</i>		16#0010
1	1025	<i>Command Bits LSW</i>		See pg. 79
2	1026	Unused		See Note Below
3	1027	Unused		See Note Below
4	1028	Unused		See Note Below
5	1029	Unused		See Note Below
6	1030	Unused		See Note Below
7	1031	Unused		See Note Below
8	1032	Unused		See Note Below
9	1033	Unused		See Note Below

Table 9.5 Immediate Stop Command Block

Unused words are ignored by the SD31045E and can be any value, including parameter values in the previous command.

+Find Home (CW)

EtherNet/IP Word	Modbus/TCP Register	Function	Units	Range
0	1024	<i>Command Bits MSW</i>		16#0020
1	1025	<i>Command Bits LSW</i>		See pg. 79
2	1026	Unused		See Note Below
3	1027	Unused		See Note Below
4	1028	Programmed Speed: Upper Word	Steps/Second	Combined value between the Configured Starting Speed and 2,999,999
5	1029	Programmed Speed: Lower Word		
6	1030	Acceleration	Steps/ms/sec	1 to 5000
7	1031	Deceleration	Steps/ms/sec	1 to 5000
8	1032	Motor Current	0.1 A	10 to 44, even numbers only. Represents 1.0 to 4.4 ARMS
9	1033	Acceleration Jerk		0 to 5000

Table 9.6 +Find Home (CW) Command Block

Unused words are ignored by the SD31045E and can be any value, including parameter values in the previous command.

Command Blocks (continued)**-Find Home (CCW)**

EtherNet/IP Word	Modbus/TCP Register	Function	Units	Range
0	1024	<i>Command Bits MSW</i>		16#0040
1	1025	<i>Command Bits LSW</i>		See pg. 79
2	1026	Unused		See Note Below
3	1027	Unused		See Note Below
4	1028	Programmed Speed: Upper Word	Steps/Second	Combined value between the Configured Starting Speed and 2,999,999
5	1029	Programmed Speed: Lower Word		
6	1030	Acceleration	Steps/ms/sec	1 to 5000
7	1031	Deceleration	Steps/ms/sec	1 to 5000
8	1032	Motor Current	0.1 A	10 to 44, even numbers only. Represents 1.0 to 4.4 ARMS
9	1033	Acceleration Jerk		0 to 5000

Table 9.7 -Find Home (CCW) Command Block

Unused words are ignored by the SD31045E and can be any value, including parameter values in the previous command.

+Manual Move (CW)

EtherNet/IP Word	Modbus/TCP Register	Function	Units	Range
0	1024	<i>Command Bits MSW</i>		16#0080
1	1025	<i>Command Bits LSW</i>		See pg. 79 Bits 7 & 6 must equal "00"
2	1026	Unused		See Note Below
3	1027	Unused		See Note Below
4	1028	Programmed Speed: Upper Word	Steps/Second	Combined value between the Configured Starting Speed and 2,999,999
5	1029	Programmed Speed: Lower Word		
6	1030	Acceleration	Steps/ms/sec	1 to 5000
7	1031	Deceleration	Steps/ms/sec	1 to 5000
8	1032	Motor Current	0.1 A	10 to 44, even numbers only. Represents 1.0 to 4.4 ARMS
9	1033	Acceleration Jerk		0 to 5000

Table 9.8 +Manual Move (CW) Command Block

Unused words are ignored by the SD31045E and can be any value, including parameter values in the previous command.

Command Blocks (continued)

+Registration Move (CW)

EtherNet/IP Word	Modbus/TCP Register	Function	Units	Range
0	1024	<i>Command Bits MSW</i>		16#0080
1	1025	<i>Command Bits LSW</i>		See pg. 79 Bits 7 & 6 must equal "10"
2	1026	Stopping Distance: Upper Word	Steps	Combined value between 0 and +8,388,607
3	1027	Stopping Distance: Lower Word		
4	1028	Programmed Speed: Upper Word	Steps per Second	Combined value between the Configured Starting Speed and 2,999,999
5	1029	Programmed Speed: Lower Word		
6	1030	Acceleration	Steps/ms/sec	1 to 5000
7	1031	Deceleration	Steps/ms/sec	1 to 5000
8	1032	Min. Reg. Move Distance: Upper Word	Steps	Combined value between 0 and +8,388,607
9	1033	Min. Reg. Move Distance: Lower Word		

Table 9.9 +Registration Move (CW) Command Block

-Manual Move (CCW)

EtherNet/IP Word	Modbus/TCP Register	Function	Units	Range
0	1024	<i>Command Bits MSW</i>		16#0100
1	1025	<i>Command Bits LSW</i>		See pg. 79 Bits 7 & 6 must equal "00"
2	1026	Unused		See Note Below
3	1027	Unused		See Note Below
4	1028	Programmed Speed: Upper Word	Steps/Second	Combined value between the Configured Starting Speed and 2,999,999
5	1029	Programmed Speed: Lower Word		
6	1030	Acceleration	Steps/ms/sec	1 to 5000
7	1031	Deceleration	Steps/ms/sec	1 to 5000
8	1032	Motor Current	0.1 A	10 to 44, even numbers only. Represents 1.0 to 4.4 ARMS
9	1033	Acceleration Jerk		0 to 5000

Table 9.10 -Manual Move (CCW) Command Block

Unused words are ignored by the SD31045E and can be any value, including parameter values in the previous command.

Command Blocks (continued)**–Registration Move (CCW)**

EtherNet/IP Word	Modbus/TCP Register	Function	Units	Range
0	1024	<i>Command Bits MSW</i>		16#0100
1	1025	<i>Command Bits LSW</i>		See pg. 79 Bits 7 & 6 must equal “10”
2	1026	Stopping Distance: Upper Word	Steps	Combined value between 0 and +8,388,607
3	1027	Stopping Distance: Lower Word		
4	1028	Programmed Speed: Upper Word	Steps per Second	Combined value between the Configured Starting Speed and 2,999,999
5	1029	Programmed Speed: Lower Word		
6	1030	Acceleration	Steps/ms/sec	1 to 5000
7	1031	Deceleration	Steps/ms/sec	1 to 5000
8	1032	Min. Reg. Move Distance: Upper Word	Steps	Combined value between 0 and +8,388,607
9	1033	Min. Reg. Move Distance: Lower Word		

Table 9.11 –Registration Move (CCW) Command Block

Encoder Follower Move

EtherNet/IP Word	Modbus/TCP Register	Function	Units	Range
0	1024	<i>Command Bits MSW</i>		16#0080 or 16#0100
1	1025	<i>Command Bits LSW</i>		See pg. 79 Bit 6 must equal “1”
2	1026	Electronic Gearing Numerator		1 to 255
3	1027	Electronic Gearing Denominator		1 to 255
4	1028	Programmed Speed: Upper Word	Steps/Second	Combined value between the Configured Starting Speed and 2,999,999
5	1029	Programmed Speed: Lower Word		
6	1030	Acceleration	Steps/ms/sec	1 to 5000
7	1031	Deceleration	Steps/ms/sec	1 to 5000
8	1032	Motor Current	0.1 A	10 to 44, even numbers only. Represents 1.0 to 4.4 ARMS
9	1033	Acceleration Jerk		0 to 5000

Table 9.12 Encoder Follower Move Command Block

Command Blocks (continued)

Preset Position

EtherNet/IP Word	Modbus/TCP Register	Function	Units	Range
0	1024	<i>Command Bits MSW</i>		16#0200
1	1025	<i>Command Bits LSW</i>		See pg. 79
2	1026	Position Preset Value: Upper Word	Steps	Combined value between -8,388,608 and +8,388,607
3	1027	Position Preset Value: Lower Word		
4	1028	Unused		See Note Below
5	1029	Unused		See Note Below
6	1030	Unused		See Note Below
7	1031	Unused		See Note Below
8	1032	Unused		See Note Below
9	1033	Unused		See Note Below

Table 9.13 Preset Position Command Block

Unused words are ignored by the SD31045E and can be any value, including parameter values in the previous command.

Presetting the position will also reset the *Move Complete* status bit in the Network Input Data.

Reset Errors

EtherNet/IP Word	Modbus/TCP Register	Function	Units	Range
0	1024	<i>Command Bits MSW</i>		16#0400
1	1025	<i>Command Bits LSW</i>		See pg. 79 Set bit 10 to clear motor faults
2	1026	Unused		See Note Below
3	1027	Unused		See Note Below
4	1028	Unused		See Note Below
5	1029	Unused		See Note Below
6	1030	Unused		See Note Below
7	1031	Unused		See Note Below
8	1032	Unused		See Note Below
9	1033	Unused		See Note Below

Table 9.14 Reset Errors Command Block

Unused words are ignored by the SD31045E and can be any value, including parameter values in the previous command.

Resetting errors will also reset the *Move Complete* status bit in the Network Input Data.

Command Blocks (continued)**Run Assembled Move**

EtherNet/IP Word	Modbus/TCP Register	Function	Units	Range
0	1024	<i>Command Bits MSW</i>		16#2000
1	1025	<i>Command Bits LSW</i>		See pg. 79 Blend Move: Bit 9 = "0" Dwell Move: Bit 9 = "1" Move direction set by Bit 4.
2	1026	Unused		See Note Below
3	1027	Unused		See Note Below
4	1028	Unused		See Note Below
5	1029	Unused		See Note Below
6	1030	Unused		See Note Below
7	1031	Unused		See Note Below
8	1032	Unused		See Note Below
9	1033	Unused with Blend Move Dwell Time with Dwell Move	milliseconds	0 to 65,535

Table 9.15 Run Assembled Move Command Block

Unused words are ignored by the SD31045E and can be any value, including parameter values in the previous command.

Preset Encoder Position

EtherNet/IP Word	Modbus/TCP Register	Function	Units	Range
0	1024	<i>Command Bits MSW</i>		16#4000
1	1025	<i>Command Bits LSW</i>		See pg. 79
2	1026	Encoder Preset Value: Upper Word	Steps	Combined value between -8,388,608 and +8,388,607
3	1027	Encoder Preset Value: Lower Word		
4	1028	Unused		See Note Below
5	1029	Unused		See Note Below
6	1030	Unused		See Note Below
7	1031	Unused		See Note Below
8	1032	Unused		See Note Below
9	1033	Unused		See Note Below

Table 9.16 Preset Encoder Position Command Block

Unused words are ignored by the SD31045E and can be any value, including parameter values in the previous command.

Programming Blocks

The following blocks are used to program an Assembled Move. Both of the moves, Blend Move, and Dwell Move, are programmed exactly the same way. The bit configuration used when starting the move determines which type of Assembled Move is run.

First Block

EtherNet/IP Word	Modbus/TCP Register	Function	Units	Range
0	1024	<i>Command Bits MSW</i>		16#0800
1	1025	<i>Command Bits LSW</i>		See pg. 79
2	1026	Unused		See Note Below
3	1027	Unused		See Note Below
4	1028	Unused		See Note Below
5	1029	Unused		See Note Below
6	1030	Unused		See Note Below
7	1031	Unused		See Note Below
8	1032	Unused		See Note Below
9	1033	Unused		See Note Below

Table 9.17 Assembled Move First Programming Block

Unused words are ignored by the SD31045E and can be any value, including parameter values from the previous command.

Once the first block is transmitted, the SD31045E responds by setting bits 8 and 9 in Status Word 1. (See [Status Word 1 Format](#) starting on page 90.) Once these are set, you can then start transmitting Segment Blocks.

Segment Block

EtherNet/IP Word	Modbus/TCP Register	Function	Units	Range
0	1024	<i>Command Bits MSW</i>		16#1800
1	1025	<i>Command Bits LSW</i>		See pg. 79
2	1026	Rel. Target Position: Upper Word	Steps	Combined value between -8,388,608 and +8,388,607
3	1027	Rel. Target Position: Lower Word		
4	1028	Programmed Speed: Upper Word	Steps/Second	Combined value between the Configured Starting Speed and 2,999,999
5	1029	Programmed Speed: Lower Word		
6	1030	Acceleration	Steps/ms/sec	1 to 5000
7	1031	Deceleration	Steps/ms/sec	1 to 5000
8	1032	Motor Current	0.1 A	10 to 44, even numbers only. Represents 1.0 to 4.4 ARMS
9	1033	Acceleration Jerk		0 to 5000

Table 9.18 Assembled Move Segment Programming Block

Note that each Segment Block starts with bits 11 and 12 set in the Command Bits MSW word (16#1800). When the SD31045E sees bit 12 of Command Bits MSW set, it will accept the block and reset bit 9 in Status Word 1. When your program sees this bit reset, it must respond by resetting bit 12 of Command Bits MSW. The SD31045E will respond to this by setting bit 9 in Status Word 1 and the next Segment Block can be written to the SD31045E. You can write a maximum of sixteen Segment Blocks for each Assembled Move.

Input Data Format

The correct format for the Network Input Data when the SD31045E is in Command Mode is shown below.

EtherNet/IP Word	Modbus/TCP Register	Command Mode Input Data
0	0	Status Word 1
1	1	Status Word 2
2	2	Motor Position: Upper Word
3	3	Motor Position: Lower Word
4	4	Encoder Position: Upper Word
5	5	Encoder Position: Lower Word
6	6	Captured Encoder Position: Upper Word
7	7	Captured Encoder Position: Lower Word
8	8	Value of Motor Current (X10)
9	9	Value of Acceleration Jerk Parameter

Table 9.19 Network Input Data Format: Command Mode

Status Word 1 Format

Status Word 1															
15	14	13	12	11	10	09	08	07	06	05	04	03	02	01	00
MODE	CrtIOk	ConErr	CmdErr	InErr	PosInVld	Xmt_MS	PgmMov	MvCmp	Decel	Accel	Homed	Stopped	Hold	MvCCW	MvCW

Figure 9.5 Command Mode: Status Word 1 Format

- Bit 15: Mode Bit** – “1” for Configuration Mode Programming, “0” for Command Mode Programming. The SD31045E powers up in Command Mode and shows a configuration error. The SD31045E will not power the motor or accept commands until a valid configuration is written to it.
- Bit 14: Controller OK Bit** – “1” when the SD31045E is operating without a fault, “0” when an internal fault condition exists.
- Bit 13: Configuration Error Bit** – “1” on power up before a valid configuration has been written to the SD31045E or after any invalid configuration has been written to the driver. “0” when the SD31045E has a valid configuration written to it.

NOTE

When in Command Mode, bit 13 of word 0 is set to “1” when there is a configuration error. When in Configuration Mode, bit 13 of word 0 is set to “1” when stall detection is enabled. When using the state of bit 13 of word 0 in your logic, always include the state of bit 15 of word 0 to assure that you are only acting on the bit when in the proper mode.

- Bit 12: Command Error Bit** – “1” when an invalid command has been written to the SD31045E. This bit can only be reset by the Reset Errors bit, Command Bits MSW, Bit 10. Note that setting the motor current to a value outside the range of 1.0 to 4.4 amps does not force a command error. The SD31045E simply ignores the new value and uses the value programmed when the unit was in Configuration Mode.

Input Data Format (continued)

Status Word 1 Format (continued)

Bit 11: Input Error Bit – “1” when:

- Emergency Stop input has been activated.
- Either of the End Limit Switches activates during any move operation except for homing.
- Starting a Manual Move in the same direction as an active End Limit Switch.
- If the opposite End Limit Switch is reached during a homing operation.

This bit is reset by a *Reset Errors* command. The format of the command is given on page 87.

Bit 10: Position Invalid Bit – “1” when:

- A configuration is written to the SD31045E
- The motor position has not been preset and the machine has not been homed
- The machine has not been homed
- The Network Connection has been lost and re-established.
- An Immediate or Emergency Stop has occurred
- An End Limit Switch has been reached
- A motor stall has been detected.

Absolute moves cannot be performed while the position is invalid.

Bit 9: Transmit Move Segment Bit – The SD31045E sets this bit to tell the host that it is ready to accept the data for the next segment of your assembled move profile. Its use is explained in the *Assembled Move Programming* section of this manual starting on page 31.

Bit 8: Program Move Mode Bit – The SD31045E sets this bit to signal the host that it is ready to accept assembled move profile programming data. Its use is explained in the *Assembled Move Programming* section of this manual starting on page 31.

Bit 7: Move Complete Bit – Set to “1” when the present Absolute, Relative, Manual, Registration, or Assembled Move command completes without error. This bit is reset to “0” when the next move command is written to the SD31045E, when the position is preset, or a Reset Errors command is issued to the unit. This bit is also set along with the Command Error bit (Bit 12 of this word), when any Manual Move or Registration Move parameters are outside of their valid ranges. This bit is not set on a command error for any other type of command. Finally, this bit is not set at the end of a homing operation.

Bit 6: Decelerating Bit – Set to “1” when the present move is decelerating. Set to “0” at all other times.

Bit 5: Accelerating Bit – Set to “1” when the present move is accelerating. Set to “0” at all other times.

Bit 4: Homing Complete Bit – Set to “1” when a homing command has completed successfully, “0” at all other times.

Bit 3: Axis Stopped Bit – Set to “1” when the motor is not in motion. Note that this is stopped for any reason, not just a completed move. For example, an Immediate Stop command during a move will set this bit to “1”, but the Move Complete Bit, (bit 7 above) will not be set.

Bit 2: Hold State Bit – Set to “1” when a move command has been successfully brought into a Hold State. Hold States are explained in the Controlling Moves In Progress section starting on page 22.

Bit 1: CCW Move Bit – Set to “1” when the motor is rotating in a counter-clockwise direction.

Bit 0: CW Move Bit – Set to “1” when the motor is rotating in a clockwise direction.

Input Data Format (continued)**Status Word 2 Format**

Status Word 2															
15	14	13	12	11	10	09	08	07	06	05	04	03	02	01	00
DrvEn	Stall	OUT1St	0	HrtBeat	LmtCon	InvPar	MtnLag	DrvFit	NetLoss	PLCState	0	0	IN3St	IN2St	IN1St

Figure 9.6 Command Mode: Status Word 2 Format

- Bit 15: Driver Enabled Bit** – Set to “1” when the motor driver section of the SD31045E is enabled and current is available to the motor. Set to “0” to remove current from the motor. If this bit is set to “1”, the motor current remains present when an E-Stop input is active. Motor current is removed if there is a Driver Fault (Bit 7 below) regardless of the state of this bit. Motor current is also removed if the motor is idle and Idle Current Reduction is programmed to its *To 0%* setting.
- Bit 14: Motor Stall Detected Bit** – Set to “1” when a motor stall has been detected.
- Bit 13: Output 1 State Bit** – Present actual state of Output 1. When this bit is set to “1”, the output is in its on state and conducts current.
- Bit 12: Reserved Bit** – Will always equal zero.
- Bit 11: Heartbeat Bit** – This bit will change state approximately every 500 milliseconds. Monitor this bit to verify that the unit and network connection are operating correctly. Note that this bit is only available when in Command Mode.
- Bit 10: Limit Condition Active Bit** – This bit is set if an End Limit Switch is reached during a move. This bit will be reset when the Limit Switch changes from its active to inactive state, or when a Reset Errors Command is issued.
- Bit 9: Invalid Parameter Change Bit** – Set during a Manual Move if parameters are changed to invalid values. Parameters that can be changed during a Manual Move are Programmed Speed, Acceleration, and Deceleration. Set while in Electronic Gearing mode if the Numerator or Denominator are set outside their range of 1 to 255.
- Bit 8: Motion Lag** – When using the Hybrid Control feature, this bit will equal “1” if the actual rotor position is more than 360° behind the commanded position. This indicates a heavily loaded motor and the encoder position should be monitored for a stalled condition.
- Bit 7: Driver Fault Bit** – If the driver section of the SD31045E is enabled, this bit will be a “1” during a Overtemperature Fault, a Short Circuit Fault, or when the Interlock Jumper is missing. This fault can be cleared by issuing a *Reset Errors* programming block with the Clear Driver Fault bit, (Command Bits LSW, bit 10) set to “1”. For additional information, see *Notes on Clearing a Driver Fault* on page 94. Note that this bit is not set if the Interlock Jumper is missing when power is applied to the driver.
- Bit 6: Network Lost Error Bit** – If the physical network connection is lost at any time, this bit will be set when the connection is re-established. The Input Error bit will also be set. Note that this bit is not set if the communication loss is not due to a physical error.
- Bit 5: PLC State Bit** – On ControlLogix and CompactLogix platforms, this bit will equal “1” when the PLC is in Program mode and “0” when in Run mode. This bit will always equal “0” on all other platforms.
- Bits 4,3: Reserved Bits** – Will always equal zero.

Input Data Format (continued)

Status Word 2 Format (continued)

- Bit 2: Input3 State Bit** – “1” when Input 3 is in its active state. The active state of the input is programmed as explained in the *Configuration Word Format* section starting on page 74.
- Bit 1: Input2 State Bit** – “1” when Input 2 is in its active state. The active state of the input is programmed as explained in the *Configuration Word Format* section starting on page 74.
- Bit 0: Input1 State Bit** – “1” when Input 1 is in its active state. The active state of the input is programmed as explained in the *Configuration Word Format* section starting on page 74.

NOTE  The SD31045E does not report the state of the inputs when they are configured as encoder inputs (ABZ). The driver reports the state of the *Active Level Bit* for the input which is set in Configuration Mode.

Motor Position Data

These two inputs words report the motor position based on the number of steps output by the SD31045E. The range for the position value is -32,768,000 to 32,767,999. The data is transmitted in the Multi-Word Format described on page 51. Note that both words in the multi-word format will be negative if the position value is negative.

Encoder Position Data

These two inputs words report the encoder position based on the quadrature pulses received by the SD31045E. The range for the encoder position value is -32,768,000 to 32,767,999. The data is transmitted in the Multi-Word Format described on page 51. Note that both words in the multi-word format will be negative if the encoder position value is negative.

Captured Encoder Position Data

These two inputs words report the encoder position based on the quadrature pulses received by the SD31045E when an Input 3 transitions for its inactive to its active state. Input 3 must be configured as a Capture Encoder Value input or as a Stop Jog and Capture Encoder Value input. The range for the captured encoder position value is -32,768,000 to 32,767,999. The data is transmitted in the Multi-Word Format described on page 51. Note that both words in the multi-word format will be negative if the captured encoder position value is negative.

Notes on Clearing a Driver Fault

A Driver Fault occurs when there is an over temperature condition, a short circuit condition in the motor, or the Interlock jumper is missing. As stated in the *Using the Interlock for Emergency Stops* section on page 48, if your SD31045E is revision 5.6 or greater, then the interlock can be used as a way to disable the motor current through hardware.

When a Driver Fault occurs, the SD31045E sets bit 7 of Status Word 2 in the Network Input Data. (See *Status Word 2 Format* on page 92 for a full description of Status Word 2.) *Once you have cleared the fault condition, you can reset the Driver Fault with the following Command Block:*

Reset Driver Fault

EtherNet/IP Word	Modbus/TCP Register	Function	Units	Range
0	1024	<i>Command Bits MSW</i>		16#0400
1	1025	<i>Command Bits LSW</i>		16#0400
2	1026	Unused		See Note Below
3	1027	Unused		See Note Below
4	1028	Unused		See Note Below
5	1029	Unused		See Note Below
6	1030	Unused		See Note Below
7	1031	Unused		See Note Below
8	1032	Unused		See Note Below
9	1033	Unused		See Note Below

Table 9.20 Reset Driver Fault Command Block

Unused words are ignored by the SD31045E and can be any value, including parameter values in the previous command.

Once the command block is accepted by the SD31045E, it will respond by resetting bit 7 in Status Word 2 of the Network Input Data.

NOTE 

After this procedure, there will still be no current to the motor. This is because the Driver Enabled Bit (bit 15 of Command Bits LSW in the Network Output Data) must be reset when writing down the Reset Driver Fault Command Block. Setting this bit in the next command block will re-enable the motor.

APPENDIX A

IP ADDRESS SETUP WITH BOOTP

If your SD31045E has a firmware revision of 5.6 or below, then you cannot use the AMCI Ethernet Configurator software to set the IP address of your unit. You must use a Bootp server to set the IP address of these devices. This appendix explains how to use the Bootp server from Rockwell Automation to set the IP address.

Initial Configuration

Starting at the beginning of chapter 5, *NETWORK CONFIGURATION*, follow those instructions up to the point where you have your network interface card configured to communicate with the SD31045E. This is explained in the section *Configure Your Network Interface Card (NIC)* which is on page 54.

Using the RA BOOTP Server

Attach the SD31045E

The first step in configuring the SD31045E when using a Bootp server is attaching the driver to your computer. Any Cat5, 5e, or 6 cable can be used. You can attach the SD31045E directly to your computer or use a network switch. The SD31045E has an “auto-switch” port which eliminates the need for a crossover cable in direct connect applications.

NOTE Do not power up the SD31045E at this point. Just attach it to your network.

Start Your Bootp Server

If needed, start your Bootp server. The Bootp-DHCP server software, version 2.3, from Rockwell Automation is used in this example. The R.A. Bootp server window is broken down into two panes, “Request History” and “Relation List”. “Request History” tells you what responses come over the network and the “Relation List” shows the setup data you have entered.

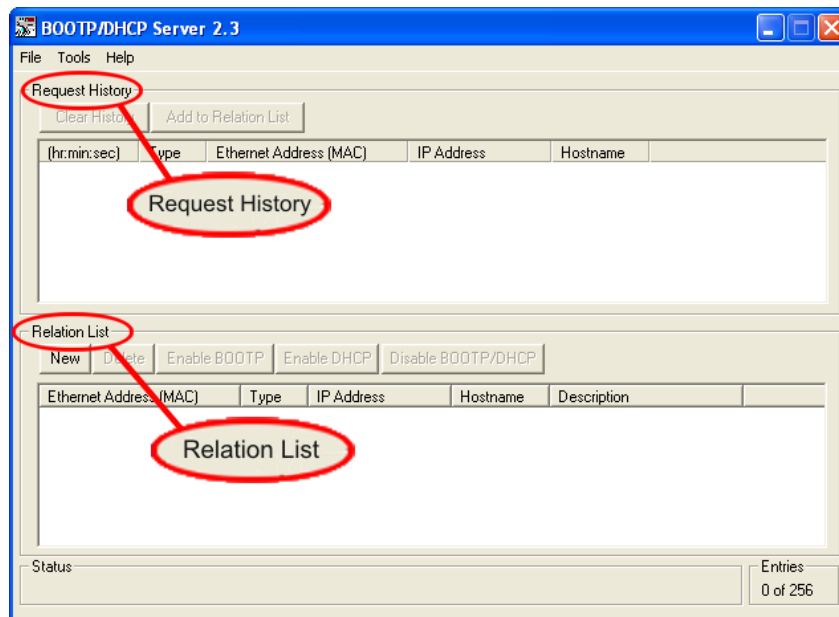

Figure A.1 RA Bootp Server

Using the RA BOOTP Server (continued)

Enabling Bootp Protocol

Changing the IP address of the SD31045E requires you to enable the Bootp protocol on the driver before you can change the IP address. The SD31045E has the Bootp protocol disabled by default. This decreases the boot time by about 30 seconds when power is applied to the driver because it doesn't have to wait for the Bootp request to time out before continuing with its stored address.

- 1) In the "Relation List" pane of the RA Bootp Server software, click on [New]. In the window that opens, enter the MAC address of the SD31045E which is printed on the driver's serial number tag. You do not have to enter the "-" characters when entering the address on the screen. You must also enter the IP address that the SD31045E presently has. This is 192.168.0.50 by default. The hostname and Description fields can be left blank. Click [OK].
- 2) Apply power to the SD31045E and wait for the Unit Status LED to come on solid green and the Network Status LED to be flashing green.
- 3) Click on your new entry in the "Relation List". This will activate the buttons in the pane. Click on the [Enable BOOTP] button. The message "[Enable BOOTP] Command successful" should appear instantly in the status line at the bottom of the window. Figure A.3 shows the state of the RA Bootp Server software at this point.

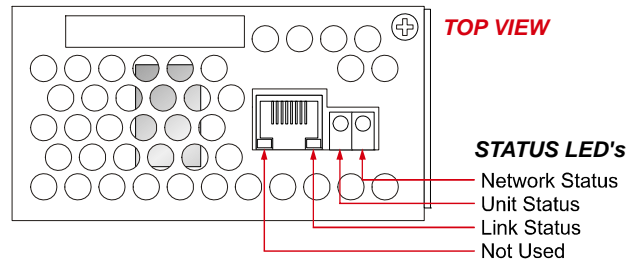

Figure A.2 Network LED's

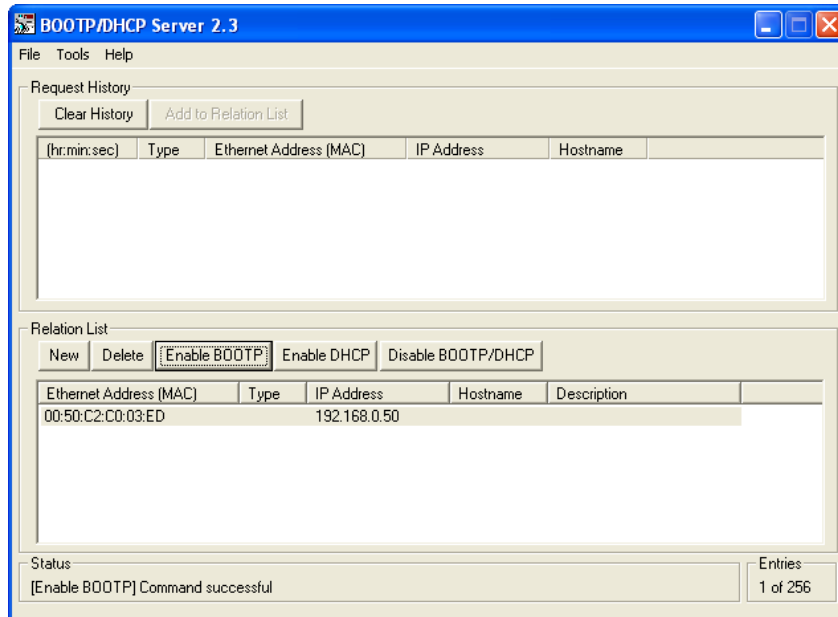

Figure A.3 Bootp Enabled

- 4) The BOOTP protocol is now enabled on the SD31045E.

NOTE Remove power from the driver before continuing.

Using the RA BOOTP Server (continued)

Setting the IP Address

With the Bootp protocol enabled on the driver, you can now change the IP address of the SD31045E.

- 1) Double click on your new entry in the "Relation List" This will bring up the Properties window again. Enter the new IP address for the SD31045E and click [OK].

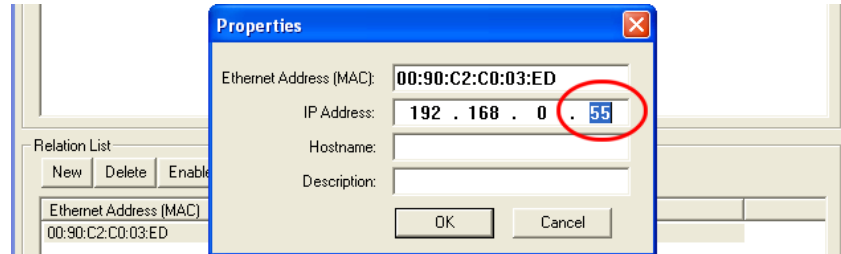

Figure A.4 Defining the New IP Address

- 2) In the menu bar, click on "Tools" and then "Network Settings". The Network Settings window opens that allows you to set the Subnet Mask, Gateway, and DNS settings. The Gateway address must be set for the SD31045E products. AMCI suggests setting this address to the host IP address.

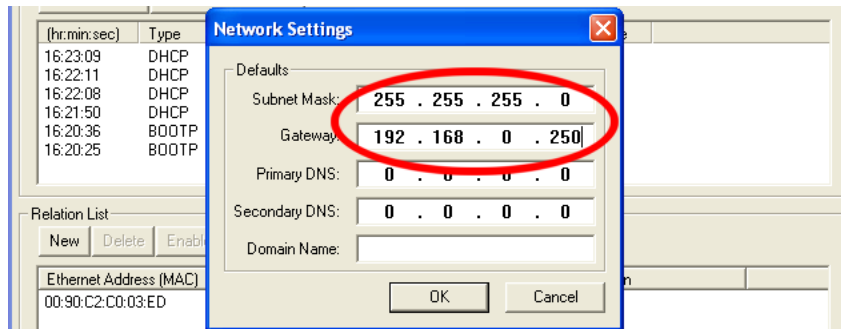

Figure A.5 Setting Gateway Address

- 3) Apply power to the driver and wait for the Unit Status LED to come on solid green and the Network Status LED to be flashing green. At this point, you should also have a message in the "Request History" pane that lists the MAC address of the SD31045E along with the IP address you requested.

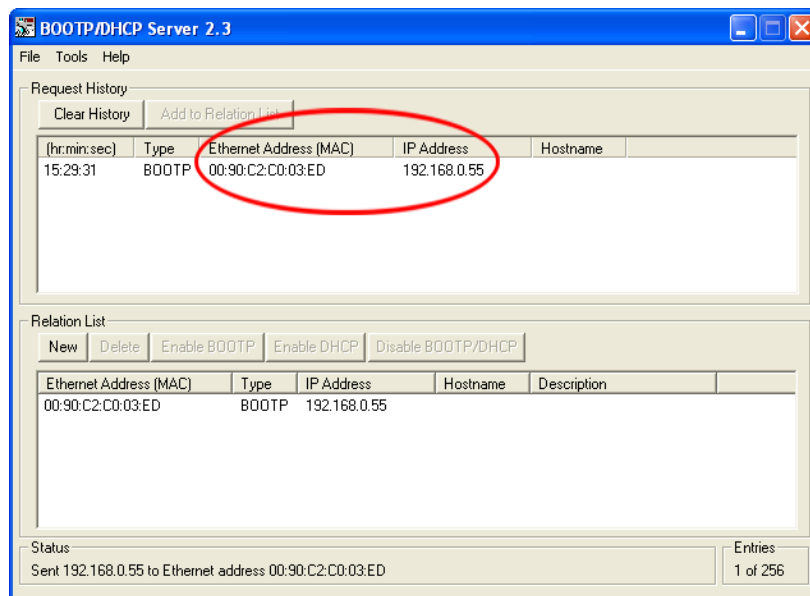

Figure A.6 New IP Address Set in SD31045E

Using the RA BOOTP Server (continued)

Disabling the Bootp Protocol

Even though not strictly necessary, disabling the Bootp protocol will allow the SD31045E to boot up faster and prevent inadvertent changes to the IP address of the SD31045E if there is a network mis-configuration on your machine or plant floor.

- 1) With power still applied to the driver, click on your new entry in the “Relation List”. This will enable the buttons above it.
- 2) Click on the [Disable BOOTP/DHCP] button. The message “[Disable BOOTP] Command successful” should appear instantly in the status line at the bottom of the window.

The SD31045E is now configured.

Testing the New IP Address

The easiest way to test the new address of the SD31045E is with the “ping” command. Before you can use the command, you have to be sure the SD31045E and your computer are still on the same subnet. For example, if the new address of the SD31045E is 192.168.0.42 and your computer has an address of 192.168.0.1, with a subnet mask of 255.255.255.0, then the two pieces of equipment are on the same subnet. (In this case, the first three numbers of the IP address must match.) If the new address of the SD31045E is 192.168.50.50, then the computer and SD31045E are not on the same subnet and you must go back into the Network Configuration panel and change your adapter’s TCP/IP settings. Refer back to the [Configure Your Network Interface Card \(NIC\)](#) section of this chapter, starting on page 54 for more information.

Once you are sure your computer and SD31045E are on the same subnet, open the DOS terminal if necessary by clicking on the [Start] button, and clicking on [Run...]. A dialog box will open. Enter ‘cmd’ on the text line and press [Enter] on the keyboard.

Once the terminal is open, type in ‘ping aaa.bbb.ccc.ddd’ where ‘aaa.bbb.ccc.ddd’ is the new IP address of the SD31045E. The computer will ping the SD31045E and the message “Reply from aaa.bbb.ccc.ddd: bytes=32 time<10ms TTL=128” should appear four times.

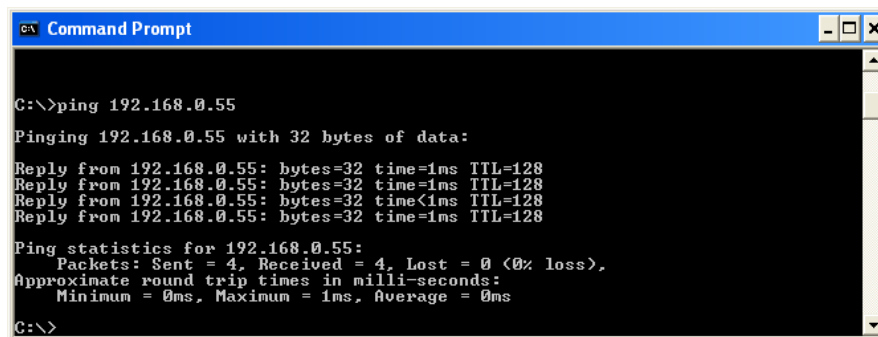

```
CA Command Prompt
C:\>ping 192.168.0.55
Pinging 192.168.0.55 with 32 bytes of data:
Reply from 192.168.0.55: bytes=32 time=1ms TTL=128
Reply from 192.168.0.55: bytes=32 time=1ms TTL=128
Reply from 192.168.0.55: bytes=32 time<1ms TTL=128
Reply from 192.168.0.55: bytes=32 time=1ms TTL=128
Ping statistics for 192.168.0.55:
    Packets: Sent = 4, Received = 4, Lost = 0 (0% loss),
    Approximate round trip times in milli-seconds:
        Minimum = 0ms, Maximum = 1ms, Average = 0ms
C:\>
```

Figure A.7 IP Address Changed Successfully

If the message “Request timed out.” or “Destination host unreachable” appears, then one of three things has occurred:

- You did not enter the correct address in the ping command.
- The new IP address of the SD31045E was not set correctly.
- The SD31045E and the computer are not on the same subnet.

APPENDIX B

UL/CUL RECOGNIZED INSTALLATIONS

The SD31045E is an Underwriter Laboratory Inc.® listed device. It is listed as “Industrial Control Equipment” under the control number 60GB. The UL file number is E231137. The SD31045E is appropriate for UL and CUL applications.

UL Required Information

If your installation is to meet UL requirements, you must be aware of the following information when using the SD31045E.

- Maximum surrounding air temperature is +50°C
- The SD31045E does not incorporate internal motor overload protection.
- The SD31045E does not provide motor over temperature protection.
- The SD31045E does not provide overspeed protection.
- The SD31045E shall be used in pollution degree 1 or 2 environments. If the SD31045E is mounted in an enclosure, this enclosure must meet these requirements.
- All wiring to the SD31045E shall be R/C (AVLV2), minimum rating of 80°C, 300V, except secondary low-voltage circuit wiring.
- Use 75°C copper conductors only.
- Terminals shall be tighten to manufacturer’s recommended torques
- Power Connector shall be rated for a minimum 12A, 600V, in a pollution degree 2 environment[†]
- Motor Connector shall be rated for a minimum 16A, 600V, in a pollution degree 2 environment[†]
- I/O Connector shall be rated for a minimum 8A, 300V, in a pollution degree 2 environment[†]

[†] Mating connectors supplied with the SD31045E meet these requirements. Additional mating connectors can be ordered directly from Phoenix Contact under the following part numbers:

Location	Phoenix Contact Part Number
Power	1737822
Motor	1912919
I/O	1803633



ADVANCED MICRO CONTROLS INC.

20 GEAR DRIVE, TERRYVILLE, CT 06786 T: (860) 585-1254 F: (860) 584-1973

www.amci.com

LEADERS IN ADVANCED CONTROL PRODUCTS