

# NR60

## Network Resolver Encoder

**EtherNet/IP Protocol  
with Device Level Ring Interface**

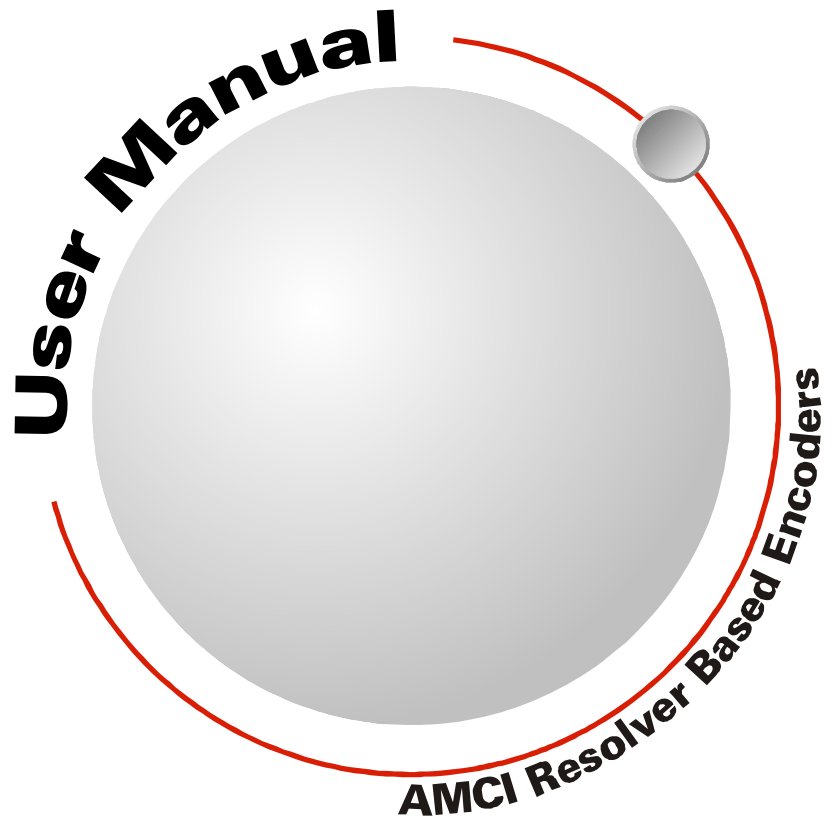

# GENERAL INFORMATION

## **Important User Information**

The products and application data described in this manual are useful in a wide variety of different applications. Therefore, the user and others responsible for applying these products described herein are responsible for determining the acceptability for each application. While efforts have been made to provide accurate information within this manual, AMCI assumes no responsibility for the application or the completeness of the information contained herein.

UNDER NO CIRCUMSTANCES WILL ADVANCED MICRO CONTROLS, INC. BE RESPONSIBLE OR LIABLE FOR ANY DAMAGES OR LOSSES, INCLUDING INDIRECT OR CONSEQUENTIAL DAMAGES OR LOSSES, ARISING FROM THE USE OF ANY INFORMATION CONTAINED WITHIN THIS MANUAL, OR THE USE OF ANY PRODUCTS OR SERVICES REFERENCED HEREIN.

No patent liability is assumed by AMCI, with respect to use of information, circuits, equipment, or software described in this manual.

The information contained within this manual is subject to change without notice.

This manual is copyright 2015 by Advanced Micro Controls Inc. You may reproduce this manual, in whole or in part, for your personal use, provided that this copyright notice is included. You may distribute copies of this complete manual in electronic format provided that they are unaltered from the version posted by Advanced Micro Controls Inc. on our official website: [www.amci.com](http://www.amci.com). You may incorporate portions of this documents in other literature for your own personal use provided that you include the notice "Portions of this document copyright 2015 by Advanced Micro Controls Inc." You may not alter the contents of this document or charge a fee for reproducing or distributing it.

## **Standard Warranty**

ADVANCED MICRO CONTROLS, INC. warrants that all equipment manufactured by it will be free from defects, under normal use, in materials and workmanship for a period of [18] months. Within this warranty period, AMCI shall, at its option, repair or replace, free of charge, any equipment covered by this warranty which is returned, shipping charges prepaid, within eighteen months from date of invoice, and which upon examination proves to be defective in material or workmanship and not caused by accident, misuse, neglect, alteration, improper installation or improper testing.

The provisions of the "STANDARD WARRANTY" are the sole obligations of AMCI and excludes all other warranties expressed or implied. In no event shall AMCI be liable for incidental or consequential damages or for delay in performance of this warranty.

## **Returns Policy**

All equipment being returned to AMCI for repair or replacement, regardless of warranty status, must have a Return Merchandise Authorization number issued by AMCI. Call (860) 585-1254 with the model number and serial number (if applicable) along with a description of the problem during regular business hours, Monday through Friday, 8AM - 5PM Eastern. An "RMA" number will be issued. Equipment must be shipped to AMCI with transportation charges prepaid. Title and risk of loss or damage remains with the customer until shipment is received by AMCI.

## **24 Hour Technical Support Number**

24 Hour technical support is available on this product. If you have internet access, start at [www.amci.com](http://www.amci.com). Product documentation and FAQ's are available on the site that answer most common questions.

If you require additional technical support, call (860) 583-1254. Your call will be answered by the factory during regular business hours, Monday through Friday, 8AM - 5PM Eastern. During non-business hours an automated system will ask you to enter the telephone number you can be reached at. Please remember to include your area code. The system will page an engineer on call. Please have your product model number and a description of the problem ready before you call.

## **We Want Your Feedback**

Manuals at AMCI are constantly evolving entities. Your questions and comments on this manual are both welcomed and necessary if this manual is to be improved. Please direct all comments to: Technical Documentation, AMCI, 20 Gear Drive, Terryville CT 06786, or fax us at (860) 584-1973. You can also e-mail your questions and comments to [techsupport@amci.com](mailto:techsupport@amci.com)

# TABLE OF CONTENTS

## **General Information**

Important User Information .....	2
Standard Warranty .....	2
Returns Policy .....	2
24 Hour Technical Support Number .....	2
We Want Your Feedback .....	2

## **About this Manual**

Audience .....	7
Applicable Units .....	7
Navigating this Manual .....	7
Manual Conventions .....	7
Trademarks and Other Legal Stuff .....	7
Revision Record .....	8
Revision History .....	8
Manual Layout .....	8

## **NR60 Specifications**

Overview .....	9
Connector Locations and Pinouts .....	10
Mating Connectors and Cordsets ...	10
Status LED's .....	11
Network Status LED .....	11
Module Status LED .....	11
Link/Activity LED's .....	11
IP Address Switches .....	12
Position Reset Switch .....	12
Electrical Specifications .....	13
Mechanical Specifications .....	13
Environmental Specifications .....	13
Part Number Description .....	14
Available Data .....	14
Programmable Parameters .....	14
Direction Counting Toggle .....	14
Scaling Function Control .....	15
Counts per Turn .....	15
Total Measurement Range .....	15
Velocity Format .....	18
Preset Value .....	18
Nonvolatile Memory .....	19
Saving the Position Offset Value ..	19
Factory Default Settings .....	19

## **Task: Set the IP Address**

Determine the Best Method for Setting the IP Address .....	21
Use Factory Default Settings .....	22
Use the NR60 IP Address Switches .....	23
Use a DHCP Server .....	24
Use the AMCI NET Configurator Utility .....	27

## **Task: Physical Installation**

Installation Guidelines .....	31
Electrostatic Discharge Prevention .....	31
Suitable Environment .....	31
Shaft Loading .....	31
A Note on Cable Direction .....	31
Availability of CAD Drawings .....	31
Outline Drawings .....	32
Servo Mount, Aluminum Body, End Connect .....	32
Servo Mount, Aluminum Body, Side Connect .....	32
Flange Mount, Aluminum Body, End Connect .....	33
Flange Mount, Aluminum Body, Side Connect .....	33
Shaft Details .....	34

## **Task: Wire Power and Ethernet**

Power Wiring Installation .....	35
Power Wiring Guidelines .....	35
Connector Location and Pinout ....	35
Right Angle Cable Exit Direction .....	35
Mating Connectors and Cordsets .....	35
Ethernet Wiring Installation .....	36
Signal Wiring Guidelines .....	36
Connector Location and Pinout ....	36
Right Angle Cable Exit Direction .....	36
TIA/EIA-568 Color Codes .....	36
Mating Connectors and Cordsets .....	36
Sample Wiring Diagram .....	37

**5000 Task: Add the NR60 to Your Studio 5000 Project**

Studio 5000 Configuration ..... 39  
 Configure the Host Controller's Ethernet Settings ..... 39  
 Add the NR60 to Your I/O Configuration Tree ..... 39  
 Check for Communication Errors ..... 41

**5000 Task: Reading Data from the NR60**

Buffer Implicit Messaging Data ..... 43  
 Implicit Messaging Data Format ..... 43  
     Assembly Instance = 1 ..... 43  
     Assembly Instance = 3 ..... 44  
 Configure Explicit Message Instructions (Optional) ..... 45

**5000 Task: Writing Data to the NR60**

Configure Explicit Message Instructions ..... 47  
 Program Parameters Instruction ..... 48  
     Program Parameters Data Format ..... 48  
 Preset Position Instruction ..... 49  
     Preset Position Data Format ..... 49  
 Save To Nonvolatile Memory Instruction ..... 49  
 Restore From Nonvolatile Memory Instruction ..... 49  
 Return to Factory Defaults Instruction ..... 50  
 Reset Device Instruction ..... 50

**500 Task: Add the NR60 to Your RSLogix 500 Project**

RSLogix 500 Configuration ..... 51  
 Configure the Host Controller's Ethernet Settings ..... 51  
 Create a Message Data File for each NR60 ..... 51  
 Create an Extended Routing Information Data File for each NR60 ..... 51

**500 Task: Reading Data from the NR60**

Read Using the Custom Assembly Instances ..... 53  
     General Tab Settings ..... 53  
     MultiHop Tab Settings ..... 54  
     Available Custom Instances ..... 54  
 Custom Assembly Data Format ..... 54  
     Assembly Instance = 1 ..... 54  
     Assembly Instance = 3 ..... 55  
 Read Using the Position Sensor Object (Optional) ..... 56  
     General Tab Settings ..... 56  
     MultiHop Tab Settings ..... 57

**500 Task: Writing Data to the NR60**

Configure Explicit Message Instructions ..... 59  
     General Tab Settings ..... 59  
     MultiHop Tab Settings ..... 60  
 Program Parameters Instruction ..... 61  
     Program Parameters Data Format ..... 61  
 Preset Position Instruction ..... 62  
     Preset Position Data Format ..... 62  
 Save To Nonvolatile Memory Instruction ..... 62  
 Restore From Nonvolatile Memory Instruction ..... 62  
 Return to Factory Defaults Instruction ..... 63  
 Reset Device Instruction ..... 63

**Optional: Install the AMCI NET Configurator Utility**

Download the AMCI Net Configurator Utility ..... 65  
 Install the AMCI Net Configurator Utility ..... 65

**Optional: Configure Your Network Interfaces**

Firewall Settings ..... 67  
 Disable All Unused Network Interfaces ..... 67  
 Configure Your Network Interface ..... 67

**Reference: CIP Position Sensor  
Object**

Common Industrial Protocol ..... 69  
Supported Services ..... 69  
Supported Instance Attributes ..... 70  
Supported Alarms ..... 71

***Notes***

# ABOUT THIS MANUAL

Read this chapter to learn how to navigate through this manual and familiarize yourself with the conventions used in it. The last section of this chapter highlights the manual's remaining chapters and their target audience.

## **Audience**

This manual explains the installation and operation of AMCI's NR60 Networked Resolver Encoders. It is written for the engineer responsible for incorporating the NR60 into a design as well as the engineer or technician responsible for its actual installation.

## **Applicable Units**

This manual is applicable to all Ethernet NR60 units with a Device Level Ring (DLR) interface. NR60 units with a DLR interface have a part number that ends with "E01" or "S01", such as 'NR60E2-S1B4-2E01'.

## **Navigating this Manual**

This manual is designed to be used in both printed and on-line forms. Its on-line form is a PDF document, which requires Adobe Acrobat Reader version 7.0+ to open it. You are allowed to select and copy sections for use in other documents and, if you own Adobe Acrobat version 7.0 or later, you are allowed to add notes and annotations. If you decide to print out this manual, all sections contain an even number of pages which allows you to easily print out a single chapter on a duplex (two-sided) printer.

## **Manual Conventions**

Three icons are used to highlight important information in the manual:



**NOTES** highlight important concepts, decisions you must make, or the implications of those decisions.



**CAUTIONS** tell you when equipment may be damaged if the procedure is not followed properly.



**WARNINGS** tell you when people may be hurt or equipment may be damaged if the procedure is not followed properly.

The following table shows the text formatting conventions:

Format	Description
Normal Font	Font used throughout this manual.
<i>Emphasis Font</i>	Font used for parameter names and the first time a new term is introduced.
<i>Cross Reference</i>	When viewing the PDF version of the manual, clicking on a blue cross reference jumps you to referenced section of the manual.
<i>HTML Reference</i>	When viewing the PDF version of the manual, clicking on a red cross reference opens your default web browser to the referenced section of the AMCI website if you have Internet access.

## **Trademarks and Other Legal Stuff**

The AMCI logo is a trademark of Advanced Micro Controls Inc. "CIP" is a trademark of Open DeviceNet Vendor Association, Inc. "EtherNet/IP" is a trademark of ControlNet International, Ltd. under license by Open DeviceNet Vendor Association, Inc. "Adobe" and "Acrobat" are registered trademarks of Adobe Systems Incorporated.

All other trademarks contained herein are the property of their respective holders.

**Revision Record**

This manual, 940-0D120 is the first release of this manual. It was first released on March 26<sup>th</sup>, 2015.

**Revision History**

940-0D120: 03/26/2015 Initial Release

**Manual Layout**

You will most likely read this manual for one of two reasons:

- ▶ If you are curious about the NR60, this manual contains the information you need to determine if the NR60 is the right product for your application. Chapter 1, NR60 Specifications, was written for you. The chapter contains all of the information you will need to fully specify the NR60 product in your application.
- ▶ If you need to install and use the NR60, then the rest of the manual is written for you. To simplify installation and configuration, the rest of the manual is broken down into *tasks* and *references*. Using the NR60 requires you to complete six tasks, and the manual is broken down into sections that explain how to complete each one.

Chapter Title	Chapter Description
<i>NR60 Specifications</i>	Complete specifications of the NR60 products.
<i>Set the IP Address</i>	Task instructions that give you the information and steps needed to set the IP Address of an NR60 resolver encoder.
<i>Physical Installation</i>	Task instructions that give you the information and steps needed to physically install an NR60 encoder on your machine.
<i>Wire Power and Ethernet</i>	Task instructions that give you the information and steps needed to wire power and ethernet connections to the NR60. These instructions are applicable to both bench top and machine wiring.
<i>Add the NR60 to Your Studio 5000 Project</i>	Task instructions that give you the information and steps needed to add the NR60 to your host controller when using Studio 5000.
<i>5000: Reading Data from the NR60</i>	Task instructions that give you the information and steps needed to read data from an NR60 encoder when using Studio 5000.
<i>5000: Writing Data to the NR60</i>	Task instructions that give you the information and steps needed to write data to an NR60 encoder when using Studio 5000.
<i>Add the NR60 to Your RSLogix 500 Project</i>	Task instructions that give you the information and steps needed to add the NR60 to your host controller when using RSLogix 500.
<i>500: Reading Data from the NR60</i>	Task instructions that give you the information and steps needed to read data from an NR60 encoder when using RSLogix 500.
<i>500: Writing Data to the NR60</i>	Task instructions that give you the information and steps needed to write data to an NR60 encoder when using RSLogix 500.
<i>Optional: Install the AMCI NET Configurator Utility</i>	Instructions for the optional task of installing the AMCI NET Configurator software.
<i>Optional: Configure Your Network Interfaces</i>	Instructions for the optional task of configuring network interfaces on your computer or laptop.
<i>Reference: CIP Position Sensor Object</i>	Reference data on the CIP Position Sensor Object implemented by the NR60.



# NR60 SPECIFICATIONS

## Overview

The NR60 is a new line of heavy-duty resolver based encoder products from AMCI. The NR60 networked resolver encoders communicate over a wired Ethernet network using the EtherNet/IP communications protocol.

Additionally, an NR60 encoder can function as a member of a Device Level Ring. A Device Level Ring (DLR) is a ODVA supported addition to the EtherNet/IP protocol that adds redundancy to the Ethernet connection.

The NR60 encoder acts as a Beacon-Based Ring Node in a Device Level Ring environment. It can process beacon packets at the default rate of every 400 microseconds. Beacon-based nodes can respond faster to network changes than nodes that only process Announce packets.

Each NR60 encoder has two external network connections using industry standard M12 D-coded connectors. These two ports are internally connected through an onboard, two port, 10/100 Mbps ethernet switch.

NR60 encoders can also be used in EtherNet/IP networks that do not support the additional DLR protocols. In these environments, the NR60 acts as a standard node in an EtherNet/IP network.

The NR60 series is composed of absolute single- or multi-turn sensors in an IP67 rated, 60 mm diameter package. All NR60 Networked Resolvers offer a maximum single turn position resolution of 16 bits, which is programmable from 1 to 65,536 counts per turn. Two multi-turn units are available in addition to the single turn NR60. One encodes 4,096 turns (12 bit + 16 bit = 28 bit encoder) and the other encodes 16,384 turns (14 bit + 16 bit = 30 bit encoder).

A flange mount unit with end connectors is shown in figure 1. The following mounting styles are available:

- ▶ 2.5 inch standard flange mount with 0.375", 0.250", or 10 mm shafts
- ▶ 58 mm standard servo mount with 6 or 10 mm shafts

Side and end connect versions of these mounting styles are available. Body material is aluminum with a powder coat finish. Outline drawings of all of the packing options are available in the [Outline Drawings](#) section of the manual starting on page 32.

Every NR60 resolver based encoder is programmable over its Ethernet interface. Parameters allow you to set the count direction, the number of counts per turn, the format of the velocity data, and preset the position data to any value within its range. The current version of the firmware also allows you to set the number of counts before returning to zero. IP address configuration can be accomplished with rotary switches on the back of the unit or through DHCP. AMCI also offers our NET Configurator Utility that can be used to program the IP Address as well as set configuration parameters.



Figure 1 NR60 Resolver Based Encoder

**Connector Locations and Pinouts**

Figure 2 below shows the location of the power and Ethernet connectors on the end connect and side connect units. It also shows the cable exit direction when right angle connectors are used with the NR60 units.

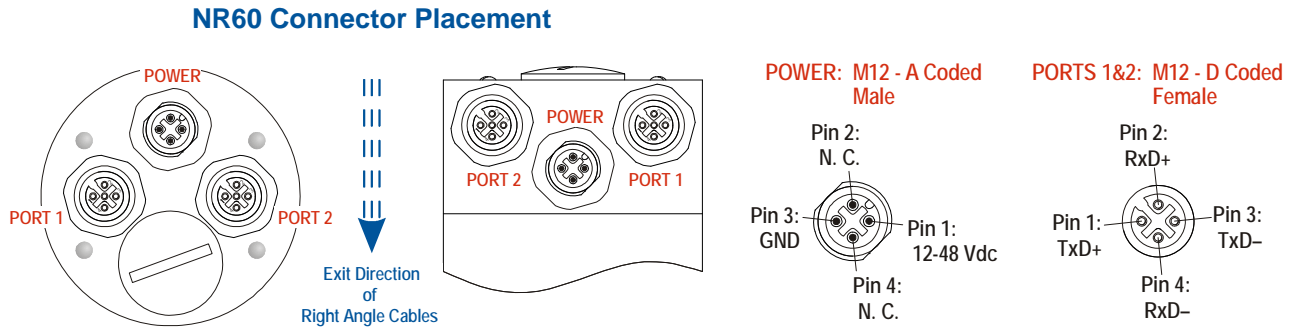

Figure 2 Connector Location and Pinout

**Mating Connectors and Cordsets**

The following mating connectors are available from AMCI. Note that any commercially available M12 connectors with the proper coding and contacts can be used.

AMCI #	Description
MS-28	Mating connector for Ethernet port connector. Screw terminal connections. 6 to 8 mm dia. cable. Straight, IP67 rated when properly installed.
MS-29	Mating connector for Power connector. Screw terminal connections. 6 to 8 mm dia. cable. 18 AWG max. Straight, IP67 rated when properly installed.

Table 1 Available Mating Connectors

AMCI offers the following cordsets for use with the NR60.

AMCI #	Description
CNER-5M	Molded cordset for Ethernet connector. 5 meters in length. Straight M12 4 pin D-coded to RJ-45 connector. IP67 rated when properly installed.
CNVL-2M	Molded cordset for Power connector. 22 AWG wire, 2 meters in length. Straight connector to flying leads. IP67 rated when properly installed.

Table 2 Available Cordsets

**Status LED's**

All NR60 resolver based encoders have four status LED's to help you determine the state of the device. These LED's are always located on the back cover of the NR60.

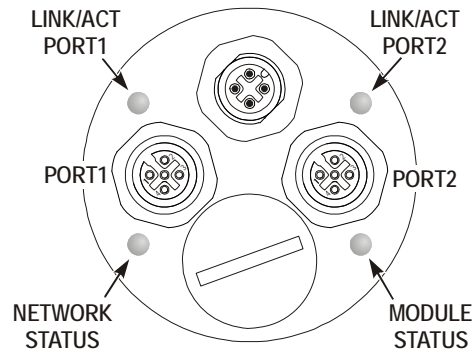

**NR60 Rear Cover**

E01 Rear Cover shown as example. Status LED locations remain the same regardless of cover type.

Figure 3 Status LED Locations

**Network Status LED**

LED State	Definition
Off	No Power
Alternating Red/Green	Power up Self-Test
Flashing Green	Ethernet IP address assigned, no CIP connection
Steady Green	Active CIP connection established
Flashing Red	Network connection timeout
Steady Red	Duplicate IP address on network

Table 3 Network Status LED States

**Module Status LED**

LED State	Definition
Off	No Power
Alternating Red/Green	Self-Test (Run on power up.)
Steady Green	Device Operational
Steady Red	Hardware Fault. (Cycle power. If fault persists, contact AMCI for support.)

Table 4 Module Status LED States

**Link/Activity LED's**

Each port has an orange Link/Activity LED. An LED is on when an Ethernet hardware connection exists on the port and blinks when there is Ethernet activity on the network segment. Note that this LED shows the state of the hardware network, not the EtherNet/IP protocols.

## IP Address Switches

The IP address setting of the NR60 is controlled with switches on the back of the unit. The switches are located behind a sealed plug. Figure 4 shows the location of the switches once the plug has been removed.

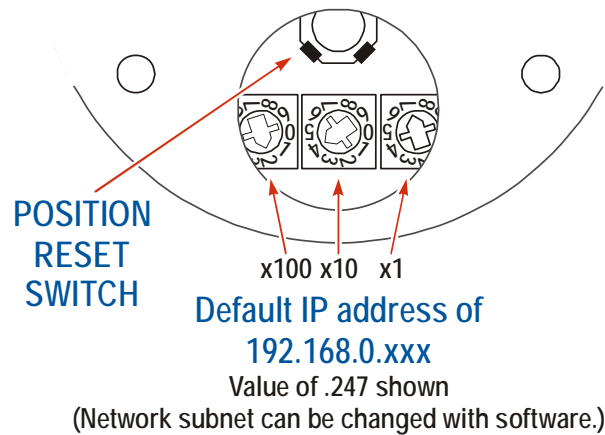

Figure 4 IP Address Switch Locations

- ▶ When the IP Address Switches are set to a value of 001 through 254, the NR60 will use the IP Address Switches to set the IP address to nnn.nnn.nnn.xxx, where 'nnn.nnn.nnn' is the last network address stored in the nonvolatile memory of the NR60 and 'xxx' is the setting of the switches.
- ▶ When the IP Address Switches are set to a value of 000, the NR60 will use the DHCP protocol to request an address from a DHCP master. A DHCP master must be present on the network when using this setting.
- ▶ When the IP Address Switches are set to a value of 255-989, the NR60 will use the last IP address saved in nonvolatile memory as its IP address.

### NOTE

- 1) Address 990 through 998 are used by the factory when testing the unit. The IP Address Switches should not be set within this range by customers in the field.
- 2) Address 999 is used to set the NR60 to a known IP address. If the switches are set to 999, the NR60 will use the IP Address of 192.168.0.50 regardless of the value stored in nonvolatile memory

## Position Reset Switch

Figure 4 also shows the location of the Position Reset Switch. The NR60 will reset the reported position to zero when this button is pressed. The resulting internal offset is automatically stored in nonvolatile memory.

**Electrical Specifications****Operating Voltage (External Supply)**

12 Vdc to 48 Vdc nominal  
11 Vdc to 54Vdc maximum

**Power Requirements**

2.5 W max.  
100 mA @ 24 Vdc typical

**Ethernet Capability**

10/100 Mbit autosense with auto-switch capability. Auto-switch eliminates the need of a crossover cable in all applications.

**Device Level Ring**

Compatible with DLR installations.  
(2) Switched Ethernet ports  
Beacon-based node, support 400  $\mu$ S updates

**Maximum Cable Length**

100 meters (330 feet), based on the Ethernet standard

**CIP Device Type**

Encoder Device (0x22)

**Single Turn Resolution**

Programmable from 1 to 65,536 counts per turn (16 bit resolution max.)

**Multi-turn Resolution**

4,096 turns (12 bit) or 16,384 (14 bit)

**Direction of Increasing Counts**

Default of CW increasing when looking at the shaft.

Programmable to CCW increasing over the EtherNet/IP interface.

**Preset Position**

Position can be preset to any value within its range via network command. Internal Position Offset can be stored in nonvolatile memory and retrieved on power up.

Position can be reset to zero via push button. Resulting position offset is automatically stored in nonvolatile memory.

**Positional Accuracy**

$\pm 10$  arc-minutes

**Electrical Specifications (continued)****Position Update Time**

1 millisecond

**Velocity Update Time**

100 milliseconds

**Mechanical Specifications****Package Style**

60 mm housing with flange or servo mounting

**Connector Location**

Side or End

**Housing**

Powder coated aluminum

**Shaft**

Flange: 0.375", 0.250", or 10 mm.

Servo: 6 mm or 10 mm with flat on shaft

**Max. Starting Torque @ 25°C**

2.0 oz-in (1.41 N-cm)

**Moment of Inertia**

$6.0 \times 10^{-4}$  oz-in-sec<sup>2</sup> ( $43.2 \times 10^{-6}$  kg-cm-sec<sup>2</sup>)

**Max. Operating Speed**

6000 RPM max.

**Max. Shaft Loading**

Axial: 20lbs. (89N)

Radial: 40lbs. (178N)

At specified max. loads, minimum bearing life is  $2 \times 10^9$  revolutions.

**Environmental Specifications****Operating Temperature**

-40°F to +185°F (-40°C to +85°C)

**Shock**

50g, 11 millisecond duration

**Vibration**

20g, 5 to 2000Hz

**Enclosure Rating**

IP67

**Approximate Weight**

1.3 lbs. (0.59 kg)

## Part Number Description

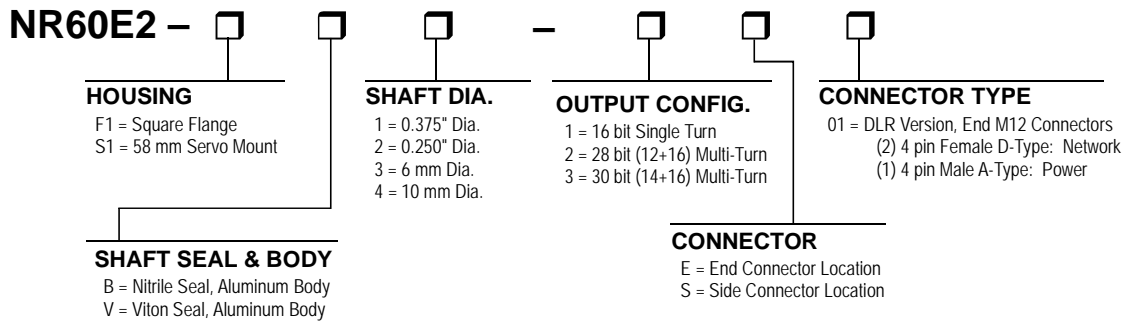

Figure 5 Part Number Description

## Available Data

All NR60 encoders offer position and velocity data that can be scaled with the programmable parameters as described in the following section. The position data can also be preset which allows you to align the position data with your machine position without having to physically rotate the shaft.

- Position and velocity data is available with custom CIP assembly instances. NR60 encoders also support the CIP Position Sensor Object, which allows you to read additional data from the NR60.

## Programmable Parameters

The following parameters are available on all NR60 encoders. Note that most of these parameter names are pulled from the ODVA (CIP) specification. They are generic, and sometimes confusing, but they are what is defined in the specification. AMCI has decided to adopt these parameter names for all NR60 encoders to avoid additional translations between protocols with one exception. In the ODVA specification, the parameter that sets the number of counts per turn of the shaft is called the ‘Measurement Units per Span’. This generic name can be applied to both rotary and linear encoders. Being that the NR60 is a rotary encoder, this manual refers to the parameter as *Counts per Turn*.

## Direction Counting Toggle

This parameter allows you to set the direction of shaft rotation needed to produce increasing counts.

- A value of “0” sets the direction of increasing counts to clockwise when looking at the shaft. This is the factory default value
- A value of “1” sets the direction of increasing counts to counter-clockwise when looking at the shaft.

## Effects of Reversing Count Direction

Changing the *Direction Counting Toggle* parameter changes the way the position value is calculated. When you reverse the count direction, the position changes from your current position value to (Maximum number of counts – current position value). For example, assume a 30 bit NR60 with its default of 65,536 counts per turn. If the current position value is 100,000 and you change the Direction Counting Toggle parameter, the current position will change to  $(2^{30} - 100,000 = 1,073,741,824 - 100,000) = 1,073,641,824$ . Most applications do not require you to change the count direction after the machine is setup, so the count direction is typically set before the position value is preset.

Changing the count direction on your machine while maintaining the current position value is a three step process. First, read and store the current position value from the NR60. Second, change the *Direction Counting Toggle* value. Third, write the stored position value back to the NR60 as a preset value.

## Programmable Parameters (continued)

### Scaling Function Control

This parameter determines if the position value reported in the network data is scaled to engineering units or if it is reported at its full 16 bit resolution. Scaling is accomplished with the Counts Per Turn parameter. (see below)

- A value of “0” disables scaling and the position data is reported at 16 bit resolution.
- A value of “1” enables scaling and the position data is reported in the engineering units set by the *Counts per Turn* parameter.



Velocity data can be reported as pulses/second, pulses/millisecond, pulses/minute, or RPM. When reported as pulses/second, pulses/millisecond, or pulses/minute, the velocity data is always scaled by the *Counts per Turn* parameter. This is useful in applications where you require the full position resolution, but want to scale velocity data to an engineering value such as inches/second, or boxes/minute.

### Counts per Turn

#### (ODVA: Measuring Units Per Span)

Used to scale the position and/or velocity data from the NR60.

- Values can range from 2 to 65,536 counts per turn for single turn NR60 units.
- Values can range from 1 to 65,536 counts per turn for multi-turn NR60 units.

Position data is only scaled if the *Scaling Function Control* parameter equals “1”. Velocity data is always scaled.

The number of turns encoded by the NR60 is not controlled with this parameter. The *Total Measurement Range* parameter is used to control when the position data rolls over to zero, which controls the number of turns encoded by the NR60.

### Total Measurement Range



When using the Total Measurement Range parameter, it is important to save your parameter values to nonvolatile memory while commissioning your machine. The position value will change when power to the NR60 is cycled if this parameter is not saved to nonvolatile memory. This step is critically important when implicit messaging is not used to communicate with the NR60.

The *Total Measurement Range* parameter sets the total number of counts before the position value returns to zero. It is always used when determining the position value. If the *Total Measurement Range* parameter is left at its default value of zero, the roll over position is determined by the *Counts per Turn* parameter and the number of turns the NR60 can encode. If the *Total Measurement Range* is non-zero, it places an upper limit on the position value and the *Preset Value* parameter. The *Total Measurement Range* parameter has the following ranges:

- **Single Turn NR60:** Range of 0, 2 to 65,536
- **28 bit Multi-turn NR60:** Range of 0, 2 to 268,435,455
- **30 bit Multi-turn NR60:** Range of 0, 2 to 1,073,741,823

Note that the value of the *Counts per Turn* parameter does not limit the range of values the can be programmed into the *Total Measurement Range* parameter. There is no fixed relationship between the *Total Measurement Range* and *Counts per Turn* parameters, which leads to interesting applications that use the two parameters.

**Programmable Parameters (continued)****Total Measurement Range (continued)***Roll Over on Fractional Number of Turns*

When the *Total Measurement Range* is less than the total counts available from the NR60, the position will return to zero before the full mechanical travel is completed.

- When the *Scaling Function Control* parameter is disabled, the total counts available equals 65,536 multiplied by the number of turns the NR60 can encode.
- When the *Scaling Function Control* parameter is enabled, the total counts available equals the value of the *Counts per Turn* parameter multiplied by the number of turns the NR60 can encode.

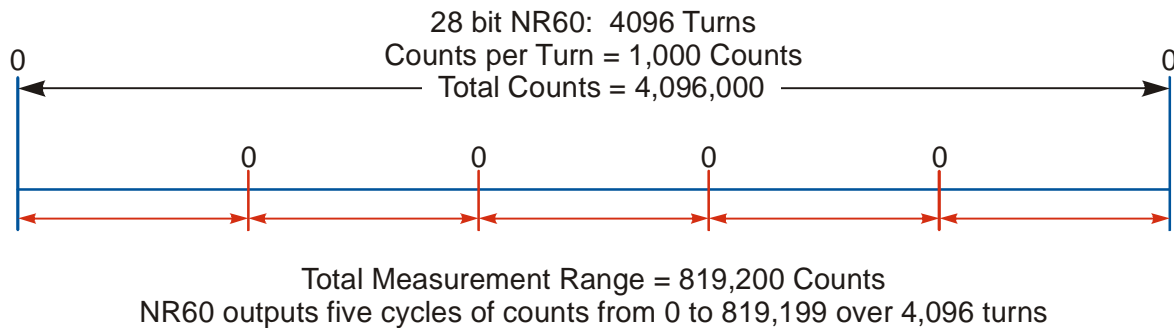

Figure 6 Fractional Turn Example 1

Figure 6 shows what occurs when the *Total Measurement Range* parameter is used to divide the full range of travel of the NR60 into equal parts. In this case, a twenty-eight bit NR60 has its 4,096 turns evenly divided into five cycles of 819.2 turns.

**NOTE** ⚠ If the value of  $\{\text{Total Counts} \div \text{Total Measurement Range}\}$  is an integer, the NR60 remains an absolute rotary sensor. You can remove power from the NR60, rotate it as far as you want, re-apply power, and the NR60 will give you the correct position value. Figure 6 is an example of this setup because the division of the two parameters results in a quotient value of five.



**Programmable Parameters (continued)****Total Measurement Range (continued)***Roll Over on Fractional Number of Turns (continued)*

Figure 7 Fractional Turn Example 2

Figure 7 shows a single turn NR60 where the *Total Measurement Range* parameter is not used to divide the full range of travel into equal parts. In this case, the position value will roll over to zero after 225 degrees of rotation. In this example the value of  $\{\text{Total Counts} \div \text{Total Measurement Range}\}$  is a real number, 1.6, instead of an integer.

**NOTE**

When the  $\{\text{Total Counts} \div \text{Total Measurement Range}\}$  quotient is a real number, the NR60 will power up with the correct position value as long as the shaft is rotated less than half of the complete span of the encoder while power was removed. In practical terms:

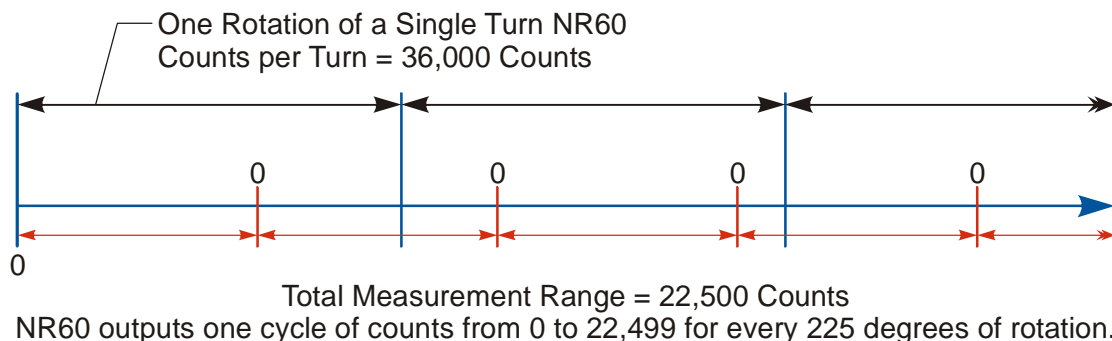
- **For 30-bit NR60 multi-turn encoders:** If you remove power from the sensor and rotate the shaft such that the point that you stop at is less than 8,192 turns from the point where you removed power, the position reading will be correct when you re-apply power.
- **For 28-bit NR60 multi-turn encoders:** If you remove power from the sensor and rotate the shaft such that the point that you stop at is less than 2,048 turns from the point where you removed power, the position reading will be correct when you re-apply power.
- **For 16-bit NR60 single turn encoders:** If you remove power from the sensor and rotate the shaft such that the point that you stop at is less than 180 degrees from the point where you removed power, the position reading will be correct when you re-apply power.

**NOTE**

If the point that you re-apply power at is greater than the limits listed above, the position value from the NR60 will be off by at least  $\pm 1$  turn.

**Encoding Additional Turns**

When the *Scaling Function Control* parameter is enabled and the *Counts per Turn* parameter is set to a value less than its maximum, the *Total Measurement Range* parameter can be used to require additional rotations of the shaft before the position value reaches the roll over count. For example, assume a single turn NR60 that has its *Counts per Turn* parameter set to 360 and its *Total Measurement Range* parameter set to 64,800. With this setup, the shaft of the NR60 must rotate 180 turns,  $\{64,800 \div 360\}$ , before the position returns to zero. In this application, the single turn NR60 acts as a 180 turn encoder with one degree position resolution.

The same trade off between resolution and number of turns encoded can be made with the multi-turn NR60 encoders. For example, if a 30-bit NR60 encoder has its *Counts per Turn* parameter set to 360 and its *Total Measurement Range* parameter set to its maximum of 1,073,741,824, the NR60 will encode 2,982,616.17 turns with one degree resolution.

In all of these applications, the NR60 has the same motion restrictions listed in the *Roll Over on Fractional Number of Turns* section above. Exceeding these limits will result in a position value error of at least  $\pm 1$  turn when power is re-applied.

## Programmable Parameters (continued)

### Velocity Format

The NR60 can transmit velocity data over the network in addition to position data. This parameter sets the units of measure for the velocity data. This integer parameter has four fixed options.

- **16#1F04 (7,940 dec.)** = pulses/second
- **16#1F05 (7,941 dec.)** = pulses/millisecond
- **16#1F07 (7,943 dec.)** = pulses/minute
- **16#1F0F (7,951 dec.)** = RPM

#### NOTE

Velocity data is always scaled by the *Counts per Turn* parameter. This is useful in applications where you require the full position resolution, but want to scale velocity data to an engineering value such as inches/second, or boxes/minute.

### Preset Value

This parameter allows you to preset the position to any value in its single or multi-turn range without rotating the shaft. The range of values depends on the state of the *Scaling Function Control* parameter and the value of the *Total Measurement Range* parameter.

- When the *Scaling Function Control* parameter is disabled:
  - If the *Total Measurement Range* parameter equals zero, the Preset Value range is:
    - 0 to 65,535 for single turn NR60 encoders
    - 0 to 268,435,455 for 28 bit multi-turn NR60 encoders
    - 0 to 1,073,741,823 for 30 bit multi-turn NR60 encoders
  - If the *Total Measurement Range* parameter is not equal to zero, the Preset Value range is:
    - 0 to (value of *Total Measurement Range* parameter) - 1
- When the *Scaling Function Control* parameter is enabled:
  - If the *Total Measurement Range* parameter equals zero, the Preset Value range is:
    - 0 to ({value of *Counts per Turn* parameter} - 1) for single turn NR60 encoders
    - 0 to ({value of *Counts per Turn* parameter \* 4,096} - 1) for 28 bit multi-turn NR60 encoders
    - 0 to ({value of *Counts per Turn* parameter \* 16,384} - 1) for 30 bit multi-turn NR60 encoders
  - If the *Total Measurement Range* parameter is not equal to zero, the Preset Value range is:
    - 0 to (value of *Total Measurement Range* parameter) - 1

## Nonvolatile Memory

The NR60 has nonvolatile memory available to store parameter values and the position offset that results from a Preset Position operation. These values are not automatically stored to nonvolatile memory when they are changed. You must issue a separate “Save to Nonvolatile Memory” command to store these values.

**NOTE**  The nonvolatile memory in the NR60 used FRAM technology, and has unlimited write cycles. Writing excessively to the memory of the NR60 will not cause a unit failure. (According to the manufacturer’s specifications, writing to the memory every millisecond will burn out the memory in approximately 300 years.)

### Saving the Position Offset Value

When the position is preset with a Preset Position command, the NR60 calculates an internal offset that is used to bring the reported position to the programmed Preset Value. This internal offset is not stored in nonvolatile memory by default and will be lost when power is removed from the unit. If you wish to store the offset, then you should issue a *Save to Nonvolatile Memory* instruction after presetting the position.

**NOTE**  1) The nonvolatile memory in the NR60 used FRAM technology, and has unlimited write cycles. Repeatedly issuing a *Save to Nonvolatile Memory* instruction will not damage the NR60.

2) If you reset the position to zero by using the Position Reset Switch on the back of the NR60, the generated position offset is automatically stored to nonvolatile memory.

3) If the *Total Measurement Range* parameter is set to a non-zero value, the position offset will automatically be stored to nonvolatile memory. In this case, issuing *Save to Nonvolatile Memory* instructions is not required, but will not cause problems if there are used.

## Factory Default Settings

The factory default settings for the NR60 are given in the table below.

Parameter	Setting
IP Address	192.168.0.50
Network Subnet Mask	255.255.255.0
Default Gateway	192.168.0.1
Count Direction	CW
Scaling Function Control	ON
Counts per Turn	65,536
Total Measurement Range	0
Velocity Format	pulses/second
Internal Position Offset	0

Table 5 Factory Default Settings

The NR60 has a “Return to Factory Defaults” command. When this command is issued over the network, the three settings that affect network addressing, IP address, Network Subnet Mask, and Default Gateway, are not changed.

If you do not know the IP address used by the NR60, you can set the IP Address Switches to a value of 999 and apply power to the NR60. The NR60 always used the default network addressing parameters listed above when the IP Address Switches to 999. See *IP Address Switches* found on page 12 for more information.

***Notes***

# REQUIRED TASK

## SET THE IP ADDRESS

This section is intended for the engineer or technician responsible for setting the IP address of an NR60 networked resolver encoder.

### 1.1 Determine the Best Method for Setting the IP Address

There are four methods for setting the IP address on an NR60. Table 1.1 below outlines the available methods and when you can use them.

Method	Restrictions	Starting page
<i>Use Factory Default Settings</i>	1) The machine must use 192.168.0.xxx subnet. 2) The 192.168.0.50 address must be available.	22
<i>Use the NR60 IP Address Switches</i>	1) If the NR60 is new from the factory or has been restored to factory defaults, the machine must use 192.168.0.xxx subnet. 2) If the IP address of the NR60 was previously set with the AMCI NET Configurator utility or through DHCP, the machine must use the last subnet programmed into the NR60.	23
<i>Use a DHCP Server</i>	No restrictions on use. The NR60 is fully compatible with the DHCP protocol. Setting the NR60 Address Switches to 000 enables the DHCP client. Once an address has been accepted over DHCP, the NR60 will save the address in nonvolatile memory and use this stored address if DHCP is later disabled.	24
<i>Use the AMCI NET Configurator Utility</i>	No restrictions on use. The software can be used to set the NR60 to any IPv4 address. The IP address will be stored in nonvolatile memory and used on subsequent power-ups. The software can also be used later to configure the parameters of the NR60.	27

Table 1.1 Methods for Setting the IP Address

**NOTE** 

There is a MAC address label on each NR60 which has a writeable surface. There is room on the label for writing the programmed IP address of the unit. It is a best practice to use this label to document the IP address of the unit in case it is ever repurposed.

**1.2a Use Factory Default Settings**

**Use the steps below to verify that the NR60 has its factory default setting.**

**1.2a.1 Remove Power**

Power should be removed from the NR60 before the IP Address switches are inspected or changed.

**1.2a.2 Remove the Rear Hole Plug**

Using figure 1.1 below as a reference, remove the rear plug to expose the IP Address switches. Place the plug in a clean environment. Dirt or oil on the threads or o-ring may prevent the plug from sealing properly when it is re-installed.

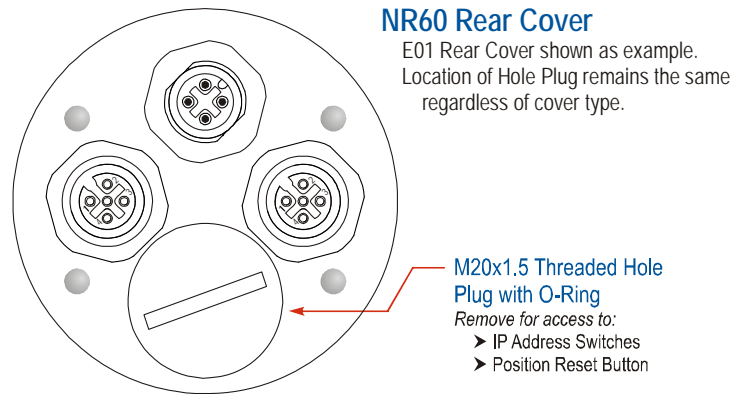

Figure 1.1 Rear Hole Plug Location

**1.2a.3 Verify IP Address Switch Settings**

Figure 1.2 below shows the IP Address Switches. The factory default setting is 900. If the switches are set to '000', the NR60 is set to use DHCP, if the are set in the range of 255 to 900, the NR60 will use the last address written to the unit. The factory saves "192.168.0.50" to nonvolatile memory before the unit is shipped. A small flat head screwdriver can be used to reset these switches to their default setting if needed.

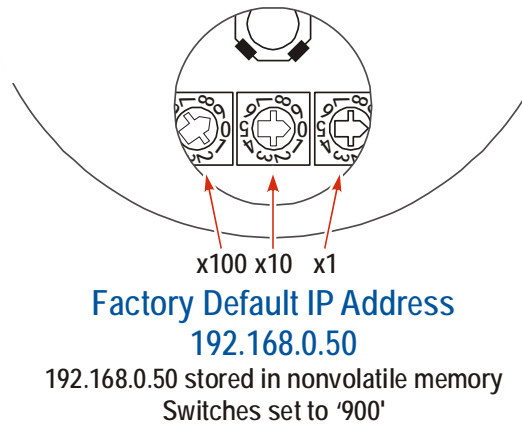

Figure 1.2 Default Setting for IP Address Switches

**1.2a.4 Replace The Rear Hole Plug**

Replace the Rear Hole Plug removed in step 1.2a.2. The plug should be tightened securely, but not over tightened, as damage the o-ring may result.

**Task Complete**

**1.2b Use the NR60 IP Address Switches**

Use the steps below to configure the NR60 for any IP address in the 192.168.0.xxx subnet.

**1.2b.1 Remove Power**

Power should be removed from the NR60 before the IP Address switches are changed.

**1.2b.2 Remove the Rear Hole Plug**

Using figure 1.3 below as a reference, remove the rear hole plug to expose the IP Address switches. Place the plug in a clean environment. Dirt or oil on the threads or o-ring may prevent the plug from sealing properly when it is re-installed.

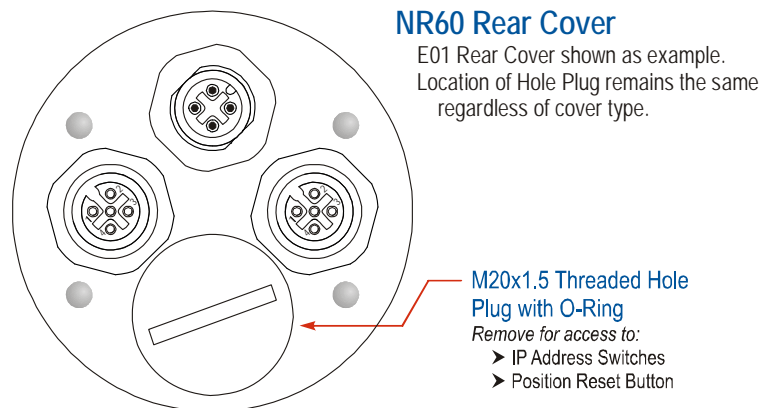

Figure 1.3 Rear Hole Plug Location

**1.2b.3 Set the IP Address Switches**

Figure 1.4 below shows the location of the IP Address Switches. A small flat head screwdriver can be used to set an address between 001 and 254. If the address is set to 000, DHCP will be enabled. If set to a value between 255 and 900, the NR60 will use the IP Address stored in its nonvolatile memory.

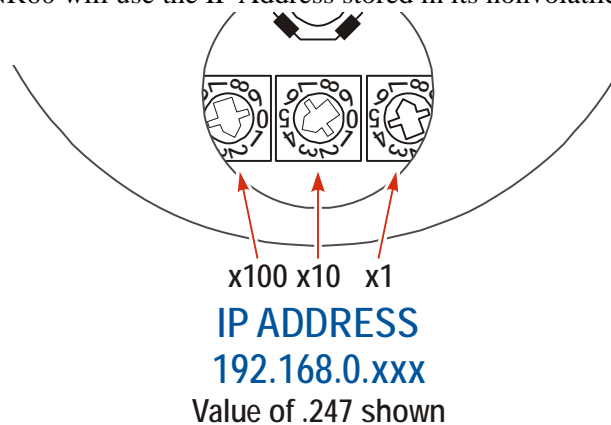

Figure 1.4 Default Setting for IP Address Switches

**1.2b.4 Replace The Rear Hole Plug**

Replace the Rear Hole Plug removed in step 1.2a.2. The plug should be tightened securely, but not over tightened, as damage the o-ring may result.

**Task Complete**

### **1.2c Use a DHCP Server**

A DHCP server can be used in one of two ways. The first method is to use the DHCP server to assign the desired IP address to the NR60 and then disable DHCP in the encoder. The other option is to have a DHCP server running on your machine's network that leases an IP address to the NR60 when the encoder requests one.

- Static DHCP leases, where the leased IP address is tied to the device's MAC ID, are typically used to guarantee that the NR60 always receives the same IP address.
- Any DHCP server can be used to configure the NR60, including the software that is available on Windows or Linux servers and consumer grade routers. These instructions uses the Rockwell Automation Bootp/DHCP server software versions 2.3 as an example.

**PREREQUISITE:** Task 3: *Wire Power and Ethernet* (page 35) This task must be completed before a DHCP server can be used to set the IP address.

#### *1.2c.1 Verify and Change the IP Address Switch Settings*

The DHCP client on the NR60 is only enabled when the IP Address Switches on the NR60 are set to a value of '000'. Follow the *Use the NR60 IP Address Switches* procedure to set the IP Address Switches to '000'. This procedure starts on page 23.

#### *1.2c.2 Document the MAC ID of the NR60*

Every NR60 device has a label on it that lists the MAC ID of the encoder. This twelve digit hexadecimal number is needed when creating a static entry in your DHCP server.

#### *1.2c.3 Configure your DHCP Server*

Once you have the MAC ID of the device, you have to configure a static entry in your DHCP server that associates the MAC ID to the IP address that you want the NR60 to use.

- The RA Bootp/DHCP server is used as an example below.

For other servers, consult their documentation for instructions on configuring a static entry. The following information is required when configuring the lease, and all other DHCP options can be ignored:

- MAC ID
- IP Address
- Subnet Mask
- Default Gateway

**NOTE**  The Default Gateway setting is not optional! In order to comply with the ODVA specification, it must be set to a valid address on the chosen subnet. Because the Default Gateway is often not used with device level networks, if you do not have a required value for it, AMCI suggests setting the Default Gateway to the IP address of your host controller.



**1.2c Use a DHCP Server (continued)****1.2c.3 Configure your DHCP Server (continued)**

- 1) Start the RA Bootp/DHCP server
- 2) Click on “Tools → Network Settings” on the menu bar to open the *Network Settings* window. Use this window to set the Subnet Mask and Default Gateway that will be used by the NR60. The DNS and Domain settings can be ignored.

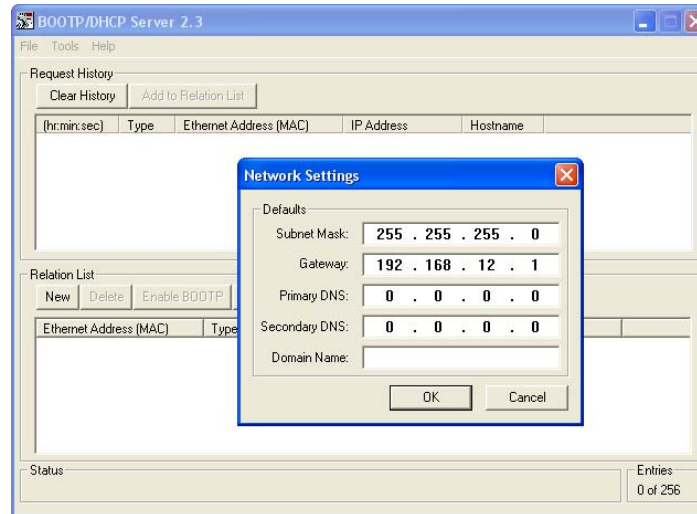

Figure 1.5 DHCP Network Settings

- 3) Click on [OK] to close the *Network Settings* window.
- 4) Under Relation List, click on the [New] button to open the *New Entry* window.
- 5) Enter the MAC ID of the NR60 and the desired IP Address. Note that the Default Gateway set above and the desired IP Address must be on the same subnet. The Hostname and Description fields can be left blank.
- 6) Click on [OK] to close the *New Entry* window. The new entry will appear in the Relation List.

**1.2c.4 Apply Power to the NR60**

Apply power and begin to monitor your DHCP server to verify that a lease has been given.

**1.2c Use a DHCP Server (continued)****1.2c.5 Wait for the DHCP Lease**

A few seconds after applying power the MAC ID of the NR60 should appear in the *Request History* list along with the desired IP Address. At this point, the Status LED's on the NR60 should be in the following state:

- Port Link/Act LED: Randomly blinking amber based on network traffic.
- Module Status: Solid green
- Network Status: Blinking green

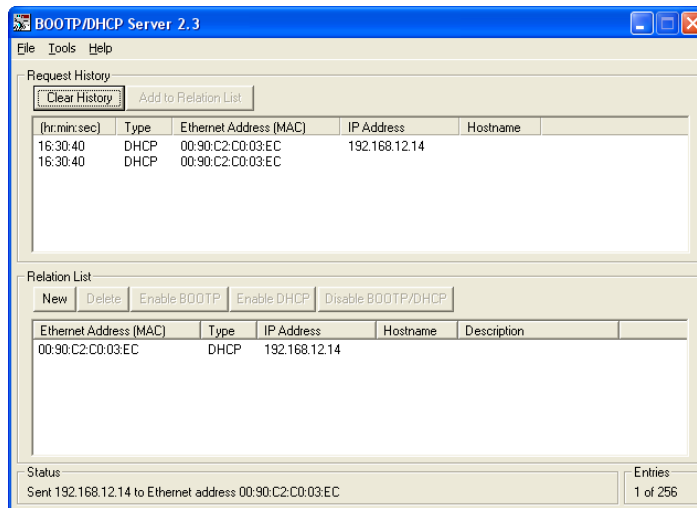

Figure 1.6 Successful DHCP Lease

If these conditions are true, the NR60 has been programmed with the desired IP address. The IP Address has been stored in nonvolatile memory.

**1.2c.6 Remove Power from the NR60**

- If the DHCP server will always be available on the machine, then the IP Address Switches on the NR60 can be left set to '000' and the NR60 will always use the DHCP server. If the DHCP server becomes unavailable, then the NR60 will not be able to join the network on power up. Per the ODVA specification, a device that is configured for DHCP must wait for a DHCP server response. It cannot timeout and use a stored default address.
- If a DHCP server will not be available on the machine, follow the *Use the NR60 IP Address Switches* procedure to set the IP Address Switches to any value between 255 and 989. This procedure starts on page 23. When the IP Address Switches are set to an invalid number, the NR60 will use the last IP address sent to it.

**NOTE**

If the IP Address Switches are set to any valid number between 1 and 254, the NR60 will use this number for the last octet of the IP address on power up. For example:

- 1) You use a DHCP server to program an address of 172.16.0.219.
- 2) The IP Address Switches are then set to '050'.

The NR60 will power up with an address of 172.16.0.**50**, not 172.16.0.219.

**NOTE**

Address 990 through 999 are used by the factory when testing the unit. The IP Address Switches should not be set within this range by customers in the field.

**Task Complete**

## 1.2d Use the AMCI NET Configurator Utility

**PREREQUISITE:** You must know the value of the IP Address Switches. They cannot have a value of 000. If they are in the range of 001 to 254, then the last octet you program as the IP Address must match the switch settings. AMCI suggests setting the switches to a value of 900 before proceeding. Task 1.2a: [Use Factory Default Settings](#), which starts on page 22 can be used to verify switch settings.

**PREREQUISITE:** Task 3: [Wire Power and Ethernet](#) (page 35) This task must be completed before the AMCI NET Configurator utility can be used to set the IP address.

**PREREQUISITE:** Optional Task A: [Install the AMCI NET Configurator Utility](#) (page 65) The AMCI NET Configurator utility must be installed on a computer before it can be used.

**PREREQUISITE:** Optional Task B: [Configure Your Network Interfaces](#). (page 67) The network interfaces on your computer must be correctly configured before you can communicate with an NR60 encoder.

### 1.2d.1 Verify that Your Host Controller is Disconnected from the NR60

EtherNet/IP is not a multi-master protocol. There can be only one bus master on the network at a time. In order to program the NR60, the AMCI NET Configurator utility must act as a bus master. Therefore, physically disconnect your host controller from the NR-60 before starting the NET Configurator utility.

### 1.2d.2 Apply or Cycle Power to the NR60

Cycling power to the NR60 will reset any connections it may have with the host controller.

### 1.2d.3 Start the AMCI NET Configurator Utility

Double click on the utility's icon. A welcome screen similar to the one in figure 1.7 below will appear.

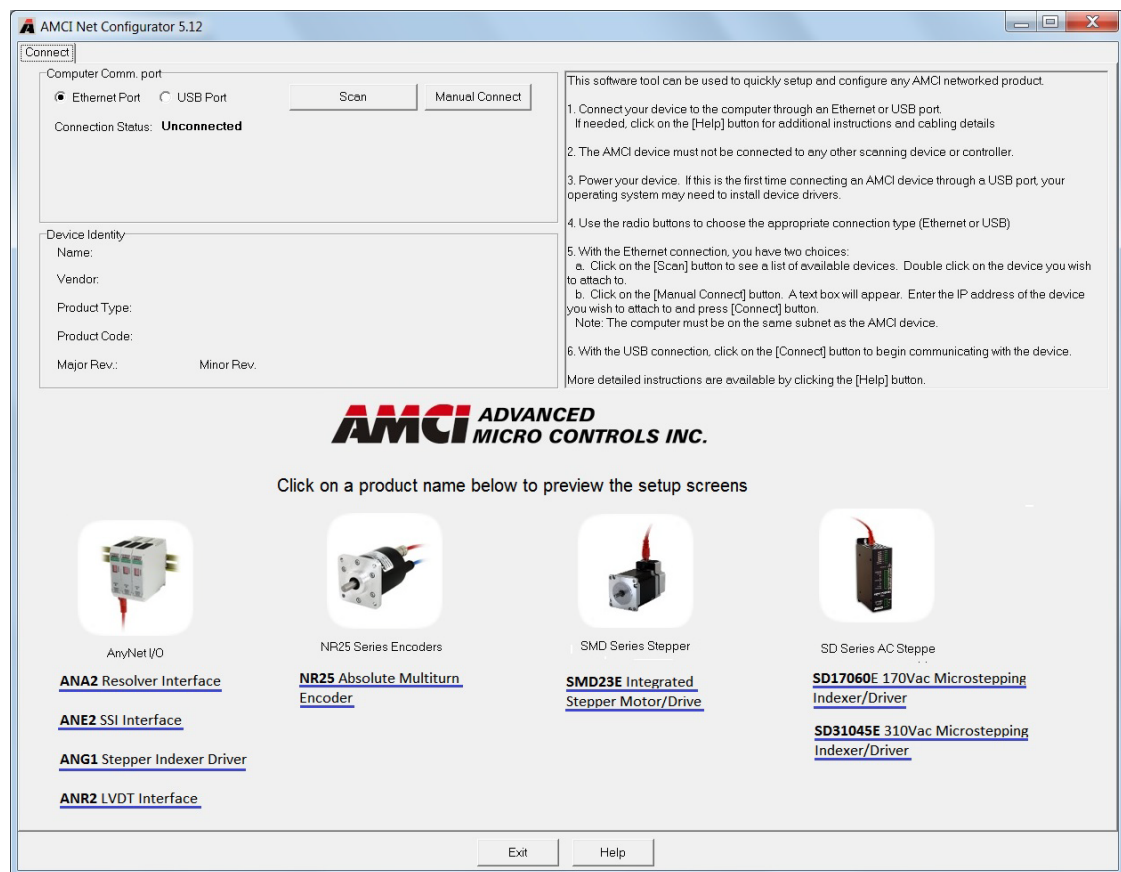

Figure 1.7 NET Configurator Welcome Screen

**1.2d Use the AMCI NET Configurator Utility (continued)****1.2d.4 Press the [SCAN] button and Connect to the NR60**

Pressing the [SCAN] button will open the window shown in figure 1.8. The NR60 will appear in the scan list only if the encoder and your network interface are on the same subnet.

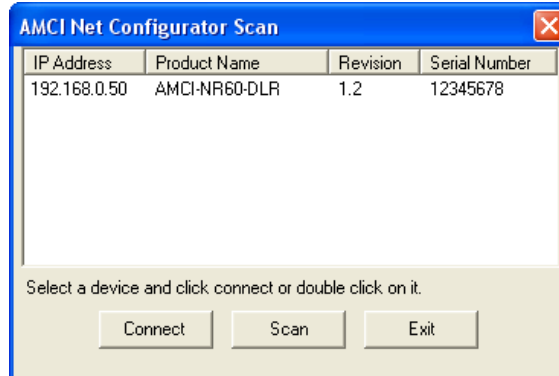

Figure 1.8 Scan for NR60

Click on the IP Address of the NR60 and click on the [Connect] button. The NET Configurator utility will connect to the encoder.

**1.2d.5 Click on the "Allow IP.." Checkbox to Access the IP Settings**

Figure 1.9 below shows the screen that results when you are connected to the NR60. In order to change the IP Address of the encoder, you must first click on the checkbox next to the text "Allow IP configuration changes. You will need to restart the device." Once the checkbox is selected, the [Set IP Address] button will be enabled.

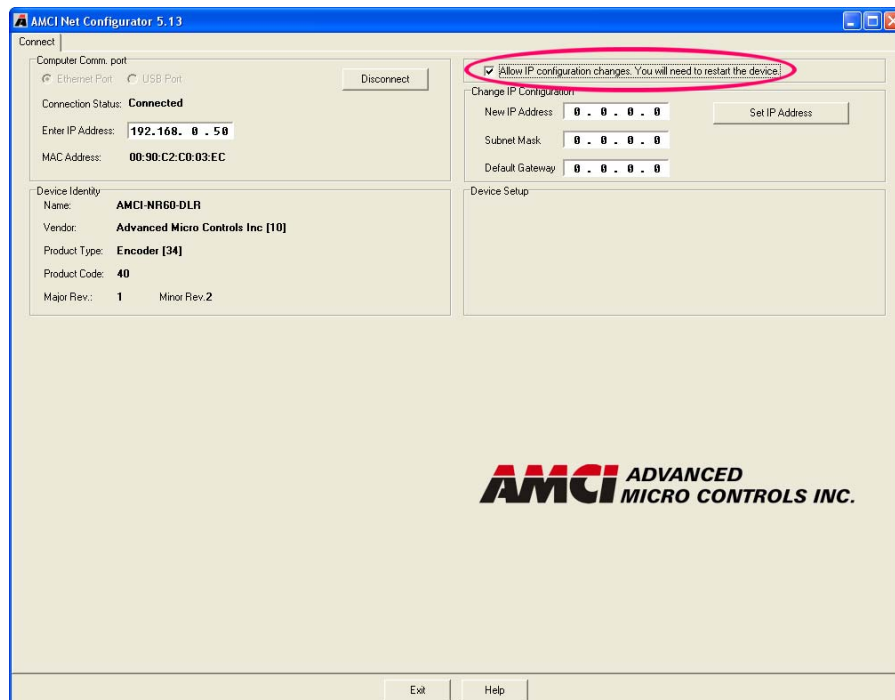



Figure 1.9 Enable IP Address Changes

## **1.2d Use the AMCI NET Configurator Utility (continued)**

### *1.2d.6 Set the IP Address, Subnet Mask, and Default Gateway*

Enter your desired values into the IP Address, Subnet Mask, and Default Gateway fields.

**NOTE**  The Default Gateway setting is not optional! In order to comply with the ODVA specification, it must be set to a valid address on the chosen subnet. Because the Default Gateway is often not used in device level networks, if you do not have a required value for it, AMCI suggests setting the Default Gateway to the IP address of your host controller.

**NOTE**  If the IP Address Switches are set to any value within the range of 1 to 254, the last octet of the IP address you program into the NET Configurator must match this value.

### *1.2d.7 Write the New IP Address to the NR60*

Click on the [Set IP Address] button. If there is an error in the settings, the utility will tell you what is wrong. Once there are all correct, the utility will write the new IP address settings to the NR60. These settings are automatically saved to nonvolatile memory.

### *1.2d.8 Remove Power from the NR60*

The new IP address will not be used until power to the NR60 has been cycled.

### *1.2d.9 Verify and Change the IP Address Switch Settings*

If the IP Address Switches are set to any valid number between 1 and 254, the NR60 will use this number for the last octet of the IP address on power up. For example:

- You use the NET Configurator utility to program an address of 172.16.0.219.
- The IP Address Switches are left at their factory default setting of 050.

The NR60 will power up with an address of 172.16.0.**50**, not 172.16.0.**219**.

Therefore, if needed, follow the *Use the NR60 IP Address Switches* procedure to set the IP Address Switches to any value between 255 and 989. This procedure starts on page 23.

**NOTE**  Do not set the IP Address Switches to a value of 000, as this will enable the DHCP client on the NR60. If the DHCP client is enabled and a DHCP server is not available, the NR60 will never receive an IP Address.

**NOTE**  Address 990 through 999 are used by the factory when testing the unit. The IP Address Switches should not be set within this range by customers in the field.

**Task Complete**

***Notes***

# REQUIRED TASK

## PHYSICAL INSTALLATION

This section is intended for the engineer or technician responsible for installing the NR60 networked resolver encoder. Information in this chapter includes installation guidelines, links to online CAD files, and mechanical drawings.

### 2.1 Installation Guidelines

#### 2.1.1 Electrostatic Discharge Prevention

Electrostatic discharge can damage the NR60 if the discharge is through the power or ethernet connectors. Follow these guidelines when handling the unit.

- 1) Touch a grounded object to discharge static potential before handling the unit.
- 2) Work in a static-safe environment whenever possible.
- 3) Do not touch the pins of the network connector or I/O connector.
- 4) Do not disassemble the unit

#### 2.1.2 Suitable Environment

The NR60 has an IP67 environmental rating and can be installed in most industrial environments, including area subject to washdown spray and temporary immersion.

**NOTE**  The IP67 rating is contingent on the proper installation of the power and ethernet mating connectors as well as the threaded hole plug. The NR60 should not be operated in an industrial environment without these items installed.

#### 2.1.3 Shaft Loading

A flexible coupler should be used when connecting an NR60 to a drive shaft, because any mismatch in shaft alignment will result in large radial or axial loading on the shaft of the encoder. Limit shaft loading to the following values. These values statistically yield an L10 life of  $2 \times 10^9$  revolutions. (Statistically, only 10% of the bearings will have failed after  $2 \times 10^9$  revolutions.) Shaft loading has an exponential effect on bearing life. The effect is actually cubic. Cutting a shaft load in half will result in an eight fold increase in bearing life.

Radial Load	Axial Load
40 lbs. (178 N)	20 lbs. (88 N)

Table 2.1 NR60 Maximum Shaft Loading Specifications

#### 2.1.4 A Note on Cable Direction

All of the dimensional drawings in the *Outline Drawings* section (2.3), show the direction that the cable exits when using right angle connectors. Use this information to properly route cables when designing the NR60 mounting.

### 2.2 Availability of CAD Drawings

CAD drawing for all NR60 devices are available on the AMCI website. Direct links to the files are:

- ▶ [http://www.amci.com/downloads/dwg/2D\\_NR60.zip](http://www.amci.com/downloads/dwg/2D_NR60.zip)  
(DWG files compatible with AutoCAD R14)
- ▶ [http://www.amci.com/downloads/step/3D\\_NR60.zip](http://www.amci.com/downloads/step/3D_NR60.zip)  
(AP203 compatible STEP files.)

**2.3 Outline Drawings**

*2.3.1 Servo Mount, Aluminum Body, End Connect*

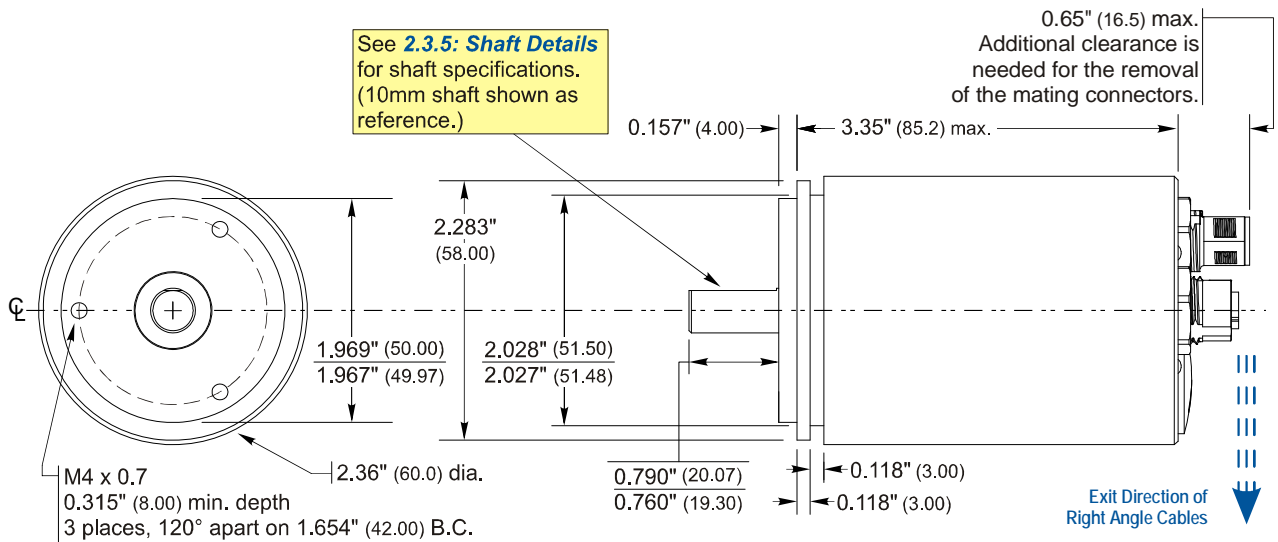

Figure 2.1 Servo Mount, Side Connector Outline Drawing

*2.3.2 Servo Mount, Aluminum Body, Side Connect*

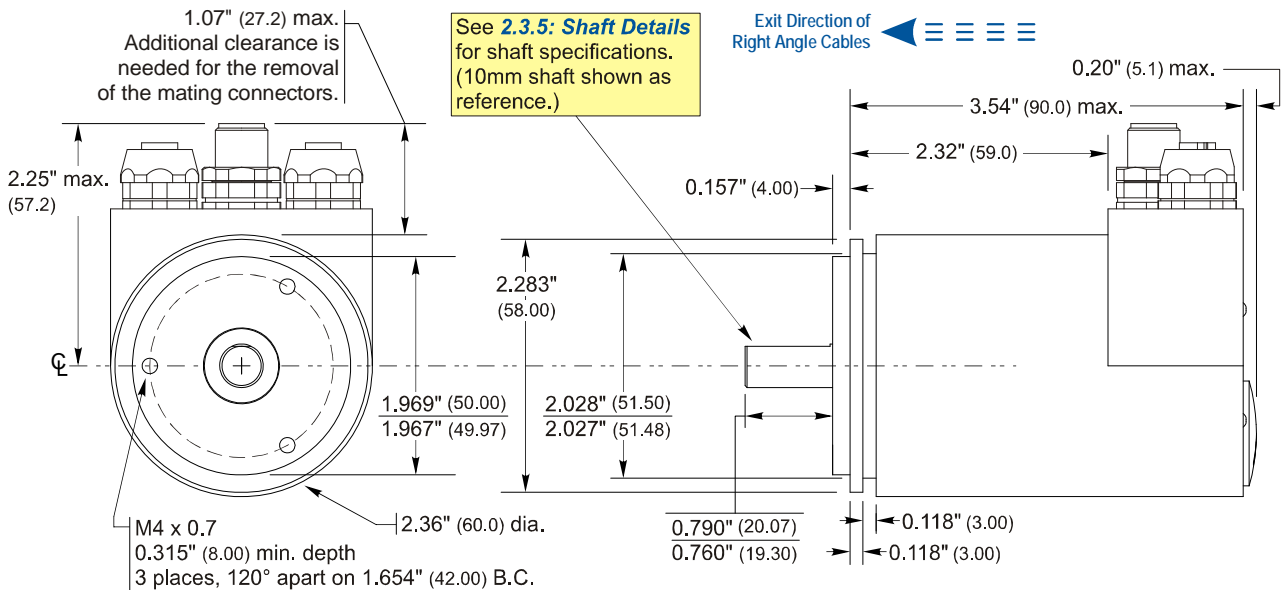

Figure 2.2 Servo Mount, Side Connector Outline Drawing



**2.3 Outline Drawings (continued)**

*2.3.3 Flange Mount, Aluminum Body, End Connect*

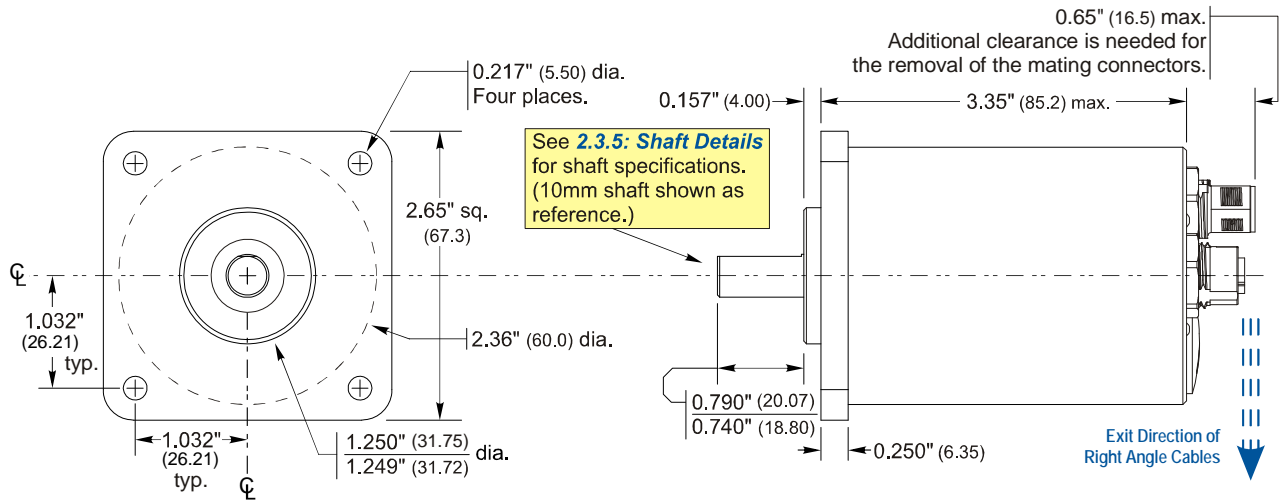

Figure 2.3 Servo Mount, Side Connector Outline Drawing

*2.3.4 Flange Mount, Aluminum Body, Side Connect*

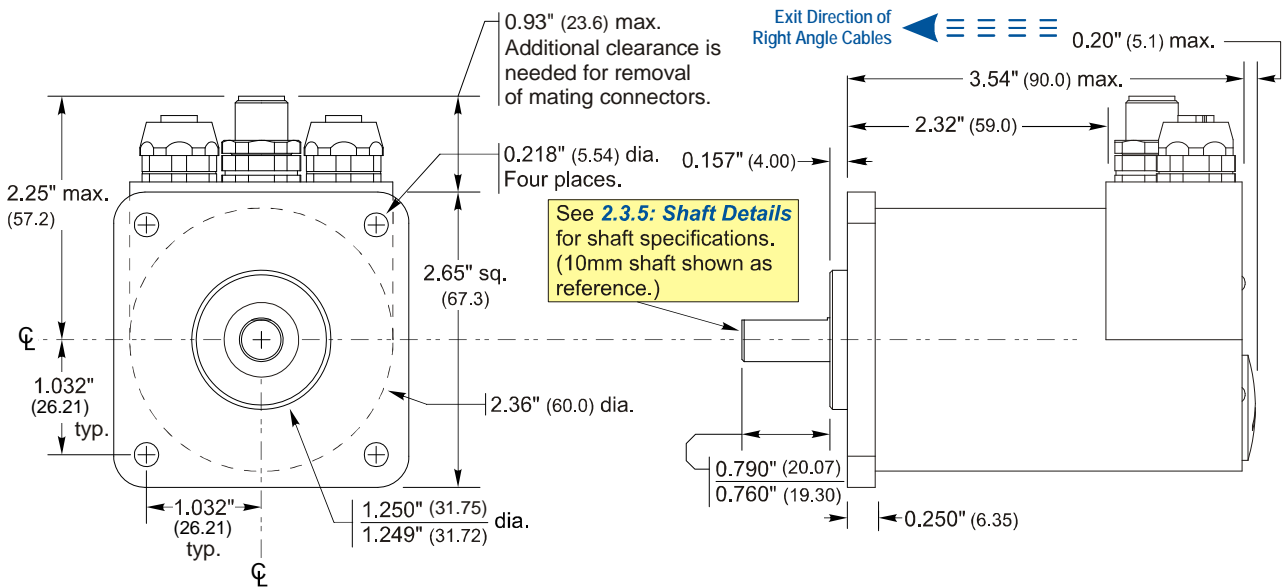
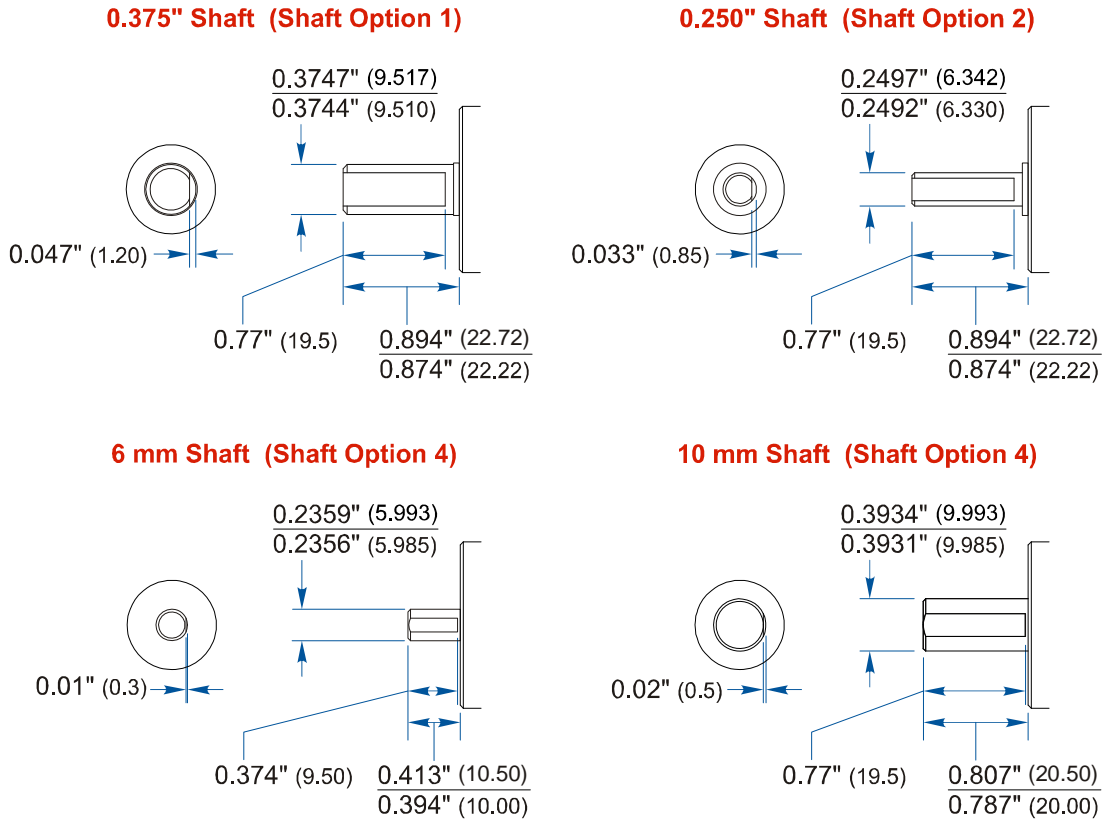

Figure 2.4 Servo Mount, Side Connector Outline Drawing

**2.3 Outline Drawings (continued)**

**2.3.5 Shaft Details**

The figure below shows the pilot of a flange mount nose. Listed dimensions are identical for the servo mount option.



() = Dimensions in mm

Figure 2.5 Shaft Details

# REQUIRED TASK

## WIRE POWER AND ETHERNET

### 3.1 Power Wiring Installation

#### 3.1.1 Power Wiring Guidelines

The NR60 requires a power supply of 12 to 48 Vdc, (11 to 54 Vdc as absolute maximums). Power requirement is 2.5W, or approximately 100 mA @ 24Vdc.

Because of the low power requirements, NR60 power wiring should not be run with high power AC or DC cabling.

#### 3.1.2 Connector Location and Pinout

Figure 3.1 below shows the power connector location on end and side connect units as well as the connector pinout.

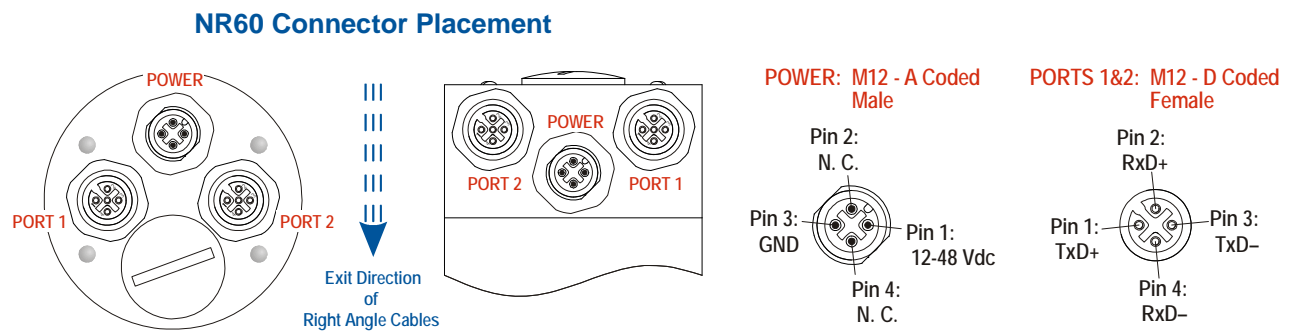

Figure 3.1 NR60 Connector Placement

#### 3.1.3 Right Angle Cable Exit Direction

When designing a mounting solution for the NR60, be aware of the cable exit direction when using right angle mating connectors. Figure 3.1 above shows the direction of the cable when using AMCI, TRUCK, or Phoenix Contact cordsets.

#### 3.1.4 Mating Connectors and Cordsets

AMCI offers the following mating connector and cordsets that mate with the NR60 power connector. Note that the power connector will mate with any connector or cordset that follows the M12, 4 pin, A-coded standard.

AMCI #	Description
MS-29	Mating connector for Power connector. Screw terminal connections. 6 to 8 mm dia. cable. 18 AWG max. Straight, IP67 rated when properly installed.
CNVL-2M	Molded cordset for Power connector. 22 AWG wire, 2 meters in length. Straight connector to flying leads. IP67 rated when properly installed.

Table 3.1 Compatible Connectors and Cordsets

**3.2 Ethernet Wiring Installation**

**3.2.1 Signal Wiring Guidelines**

- Ethernet signals are low voltage, low power, digital signals. Ethernet cables should not be run with high power AC or DC cabling.
- Ethernet cable can be run in conduits with other low power AC and DC signal cables. Ideally, cable will be run in metal conduit that is bonded along its entire length.
- Ethernet cable should not be run in parallel with high power AC or DC cabling to minimize capacitive coupling of electrical noise. If they must be run in parallel, separate them as much as possible.
- If an Ethernet cable must cross high power AC or DC cabling, it should do so at a right angle to minimize inductive coupling of electrical noise.
- Cable length must be limited to 100 meters (328 ft), between devices to comply with 802.3 Ethernet standards.

**3.2.2 Connector Location and Pinout**

Figure 3.1 in section 3.1.2 above shows the location of the two ethernet ports on end and side connect units as well as the connector pinout

**3.2.3 Right Angle Cable Exit Direction**

When designing a mounting solution for the NR60, be aware of the cable exit direction when using right angle mating connectors. Figure 3.1 above shows the direction of the cable when using AMCI, TRUCK, or Phoenix Contact cordsets.

**3.2.4 TIA/EIA-568 Color Codes**

There are two color codes in common use when wiring Ethernet connections with twisted pairs. Either one of these standards is acceptable. Note that accidentally reversing the Tx/Rx pairs will not affect the operation of the NR60. The NR60 has an “auto-sense” port that will automatically adjust for swapped pairs.

Signal	568A Color	568B Color
+Transmit (+Tx)	White/Green Tracer	White/Orange tracer
–Transmit (–Tx)	Solid Green	Solid Orange
+Receive (+Rx)	White/Orange Tracer	White/Green Tracer
–Receive (–Rx)	Solid Orange	Solid Green

Table 3.2 TIA/EIA Color Codes

**3.2.5 Mating Connectors and Cordsets**

AMCI offers the following mating connector and cordsets that mate with the NR60 Ethernet port connectors.

AMCI #	Description
MS-28	Mating connector for Ethernet port connector. Screw terminal connections. 6 to 8 mm dia. cable. Straight, IP67 rated when properly installed.
CNER-5M	Molded cordset for Ethernet connector. 5 meters in length. Straight M12 4 pin D-coded to RJ-45 connector. IP67 rated when properly installed.

Table 3.3 Compatible Connectors

## 3.2 Ethernet Wiring Installation (continued)

### 3.2.6 Sample Wiring Diagram

The diagram below shows how to wire a network cable to an NR60 for use as a programming cable.

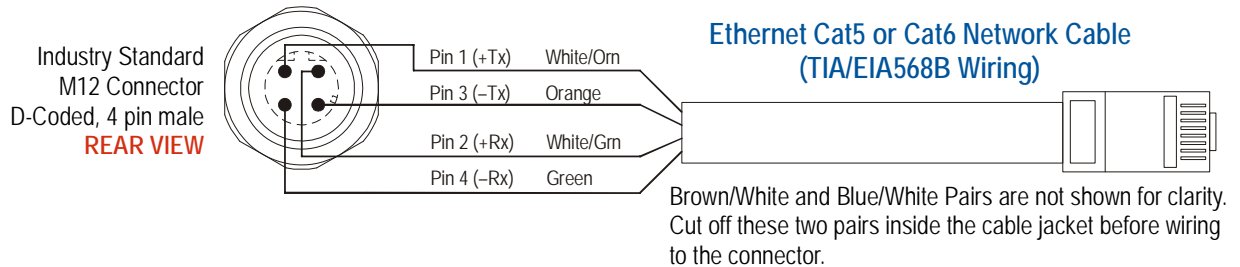

Figure 3.2 Sample Programming Cable

**NOTE** Figure 3.2 above shows the proper wiring for a cable that is terminated on the RJ45 connector to the TIA/EIA568B standard. The only difference between the 568A and 568B standards is that the two pairs are swapped. With the “auto-switch” port that is built into the NR60, the system will work correctly, regardless of which standard was used to terminate the RJ45 plug.

***Notes***

# Studio 5000 TASK

## ADD THE NR60 TO YOUR STUDIO 5000 PROJECT

This section covers how to add an NR60 to your host controller when using RA Studio 5000.

### 4.1 Studio 5000 Configuration

When using the ControlLogix and CompactLogix platforms, you have the option of using the Ethernet port that is built into some processors, or a separate Ethernet Bridge module. If the Ethernet port is built into processor, the only step you have to take before adding the NR60 is to create a new project with the correct processor or modify an existing project. Once this is done, the Ethernet port will automatically appear in the Project Tree. If you are using an Ethernet Bridge module, you will have to add the module to the I/O Configuration tree and configure it before adding the NR60 to your project.



If you are using an Ethernet Bridge module and have difficulty communicating with the NR60, you may have to upgrade the firmware of the Ethernet Bridge module to its latest version.

#### 4.1.1 Configure the Host Controller's Ethernet Settings

You should configure the Ethernet settings of your host controller before adding the NR60 to your project. Refer to RA documentation for information on configuring your controller.

#### 4.1.2 Add the NR60 to Your I/O Configuration Tree

You can add the NR60 to your project once the controller's Ethernet port is configured.

- 1) As shown in figure 4.1 on the right, the Ethernet port will be listed under the I/O Configuration tree. Right click on the port and then click on "New Module..." in the pop-up menu.
- 2) The resulting window is shown in figure 4.2. Scroll down the list until you find the entry that has a description of "Generic Ethernet Module". (Module Type is ETHERNET-MODULE in the figure.) You can limit the list to Allen-Bradley Communication Modules by setting the appropriate filters. Click on the module name to select and then click the [Create] button. A Module Properties window will open.

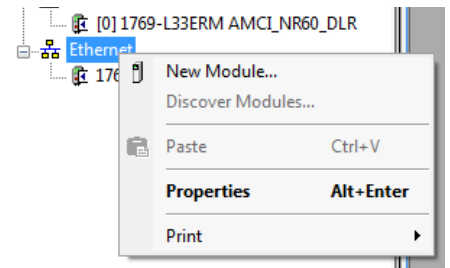

Figure 4.1 Adding an NR60

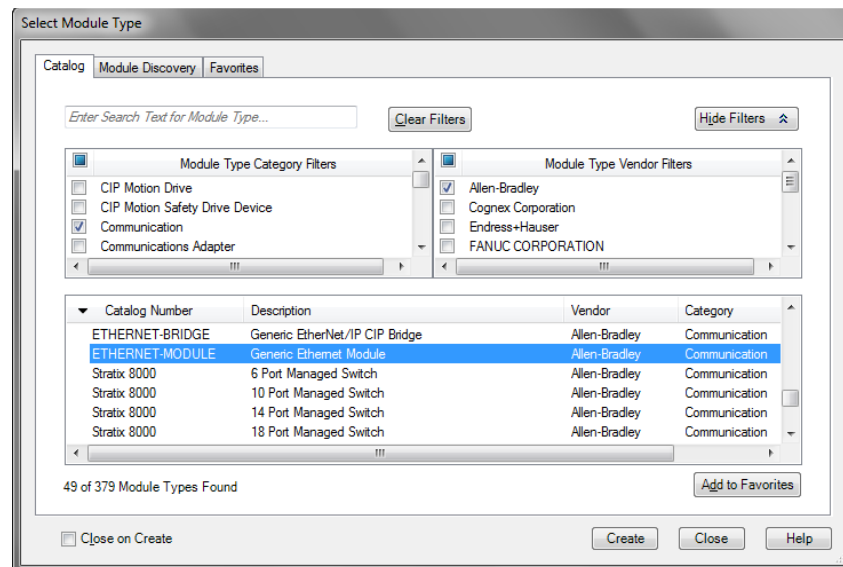

Figure 4.2 Studio 5000 Generic Module Selection

**4.1 Studio 5000 Configuration (continued)**

*4.1.2 Add the NR60 to Your I/O Configuration Tree (continued)*

3) Set the following parameters in the Module Properties window. All parameters not listed here are optional. Figure 4.3 shows a completed screen.

- **Name:** A descriptive name for the NR60.
- **Comm Format:** Input Data - DINT (*MUST be changed from the default Data - DINT.*)
- **IP Address:** Must be the address you set the NR60 to. Refer to the Required Task, [Set the IP Address](#) starting on page 21 for information on setting the IP address of the NR60.
- **Input:** You have two choices:

Assembly	Size	Data
1	1	32 bit Position Value
3	2	32 bit Position Value and 32 bit Velocity Data

Table 4.1 Input Assembly Instances

- **Output:** Assembly Instance = 152. This is an Input Data only connection, so the Output Instances is not used.
- **Configuration:** Assembly Instance = 103, Size = 0

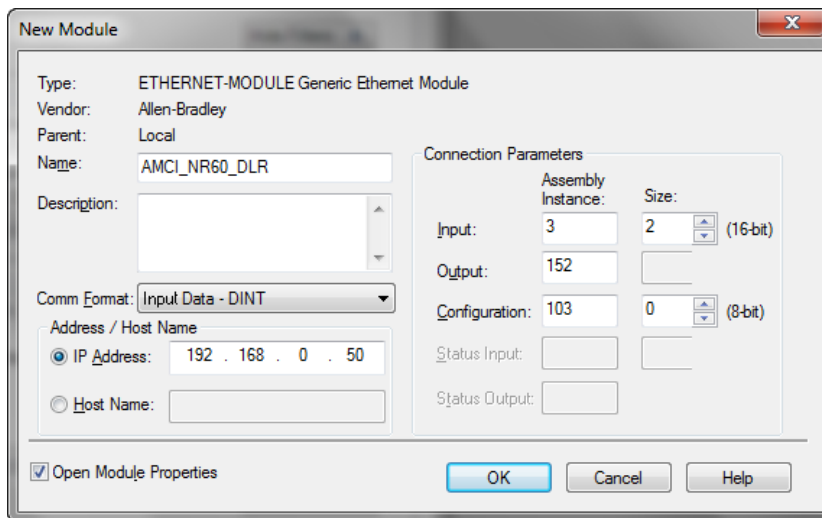

Figure 4.3 Sample NR60 Configuration Screen

4) Click on [OK] to close the window.



## 4.1 Studio 5000 Configuration (continued)

### 4.1.2 Add the NR60 to Your I/O Configuration Tree (continued)

- 5) A “Module Properties” window will automatically open if the “Open Module Properties” checkbox was left at its default setting. If the “Module Properties” window did not open, double click on the name you gave the NR60 in the I/O Configuration tree to open the window.
- 6) Click on the “Connections” tab and set the RPI time that is required for your system. The suggested minimum RPI time for an NR60 is two milliseconds. The number of nodes on the network has an effect on the minimum RPI time. (The unit has been tested to 1 millisecond with an eight node ring.) You may have to increase this RPI time if your network is heavily loaded. The remaining checkboxes can be left at their default settings. {The Unicast Connection field that is shown as checked in the figure is an optional setting.} When done, click on [OK] to complete the setup.

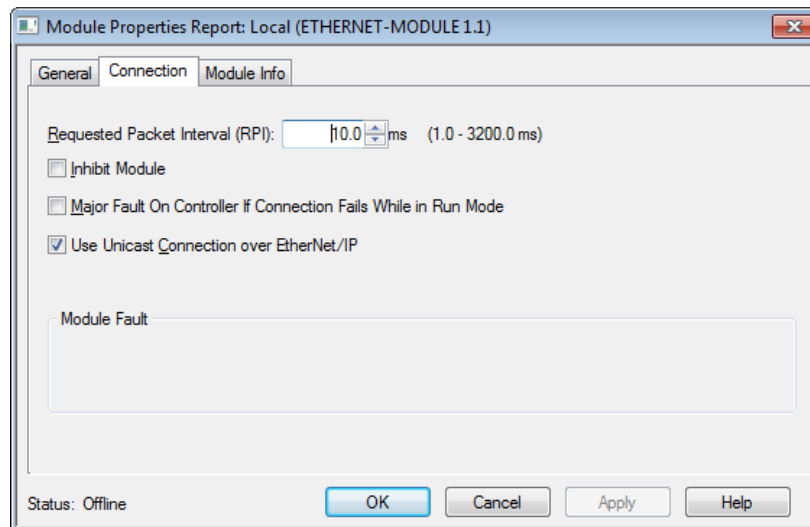

Figure 4.4 Setting the RPI Time

### 4.1.3 Check for Communication Errors

You can immediately check for errors if you are on-line with the processor while setting up the NR60. These error codes will appear in the Module Fault section of the Connection tab of the Module Properties window.

- **Error Code 16#0315 Connection Request Error: Invalid Segment Type.** You have specified an invalid assembly instance in the connection parameters.
- **No communications, but no error code.** Most commonly caused when the Comm Format not set to “Input Data - DINT” or when the number of inputs words is incorrect.

***Notes***

## READING DATA FROM THE NR60

Every PLC that uses Studio 5000 supports implicit messaging. Implicit messaging data appears in the tags that were created when the NR60 was added to the I/O Configuration tree. This data is updated at the programmed RPI time. Every PLC that uses Studio 5000 also supports explicit messaging, which can be used to retrieve specific data from the NR60.

Studio 5000 sample code for the NR60 is available on our website, [www.amci.com](http://www.amci.com).

### 5.1 Buffer Implicit Messaging Data

Implicit Messaging data is updated asynchronously to the scan at the programmed RPI time. Therefore, this data should be buffered by copying it to holding registers using a Synchronous Copy (CPS) instruction. The holding registers are then used by your PLC program. If the data is not buffered, it can change during a program scan, resulting in logical errors that may cause a machine malfunction.

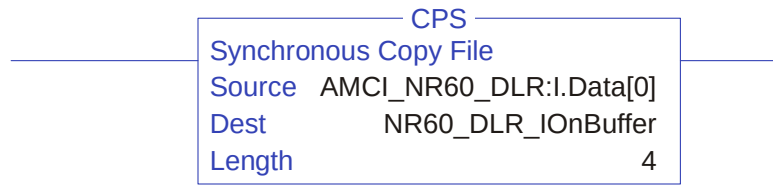

Figure 5.1 Sample CPS Instruction

The amount of data to buffer depends on the Input Assembly Instance you chose while adding the NR60 to your host controller. The table below lists the four custom Assemble Instances that are available for reading data from the NR60.

Assembly	Size	Data
1	1	32 bit Position Value
3	2	32 bit Position Value and 32 bit Velocity Data

Table 5.1 Input Assembly Instances

### 5.2 Implicit Messaging Data Format

#### 5.2.1 Assembly Instance = 1

As shown in the table below, when you set the Input Assembly Instance to 1, the input data consists of the position value transferred as two 16 bit words.

DINT #	Description
0	<p><b>Position Value.</b> The maximum position value depends on your NR60 model and the programmed counts per turn. The maximum value in all cases is 1,073,741,823 (16#3FFF FFFF). Note that the two 16 bit registers are combined into a single 32 bit data word. The values on the right show the register values in hexadecimal if the position value is 1,274,237 (16# 0013 717D)</p>

Table 5.2 Input Data, Position Only

## 5.2 Implicit Messaging Data Format (continued)

### 5.2.2 Assembly Instance = 3

As shown in the table below, when you set the Input Assembly Instance to 3, the input data consists of the position value and velocity data transferred in a total of four 16 bit words.

DINT #	Description
0	<b>Position Data.</b> The maximum position value depends on your NR60 model and the programmed counts per turn. The maximum value in all cases is 1,073,741,823 (16#3FFF FFFF). Note that the two 16 bit registers are combined into a single 32 bit data word. The values on the right show the register values in hexadecimal if the position value is 1,274,237 (16# 0013 717D)
1	<b>Velocity Data.</b> The units of measure of the velocity data is set by the Velocity Format parameter in the Configuration Data. If the Scaling Function Control bit is ever set to a "1", the position data used to calculate the velocity data is always scaled by the Measuring Units per Span parameter. Note that the two 16 bit registers are combined into a single 32 bit data word. The values on the right show the register values in hexadecimal if the velocity value is 461,725 (16# 0007 0B9D)

Table 5.3 Input Data, Position and Velocity

### 5.3 Configure Explicit Message Instructions (Optional)

In addition to the custom assemble instances that are presented in this manual, the NR60 implements the Position Sensor Object as defined in revision 2 of the CIP specification. The Position Sensor Object can be used to read additional information from the NR60, such as the position offset that is presently being used to offset the actual sensor reading.

**NOTE** Using explicit messaging to read data from an NR60 is completely optional when using Studio 5000 software. If one of the input assembly instances listed in table 5.1 above transfers all of the data you need from the device, then there is no reason to use explicit message instructions to read data from the NR60.

Before adding Message Instructions to your ladder logic, you should create a control tag for each instruction. These tags must have a 'MESSAGE' data type. These tags will hold the data and control bits for the actual data transfer. Refer to your RA documentation for additional information.

Figure 5.2 shows the two configuration screens used when setting up a message instruction to communicate with an NR60.

- 1) **Message Type:** Always "CIP Generic".
- 2) **Service Type:** Always use "Get\_Attribute\_Single" when reading data from the Position Sensor Object.
- 3) **Class:** Always 23<sub>hex</sub> when the Service Type is "Get\_Attribute\_Single".
- 4) **Instance:** Always "1" when the Service Type is "Get\_Attribute\_Single".
- 5) **Attribute:** Depends on the information you are reading with the instruction.
- 6) **Destination:** The storage location for the data read from the NR60.
- 7) **Path:** Data path to the NR60. Click on the [Browse...] button and the I/O Configuration tree will appear in a browser window. Select the NR60 in the tree and click [OK]. Click [OK] in the Message Configuration screen to accept the changes.

The [Tag] tab lists the tag used to control the message instruction. This tag must have a "MESSAGE" data type.

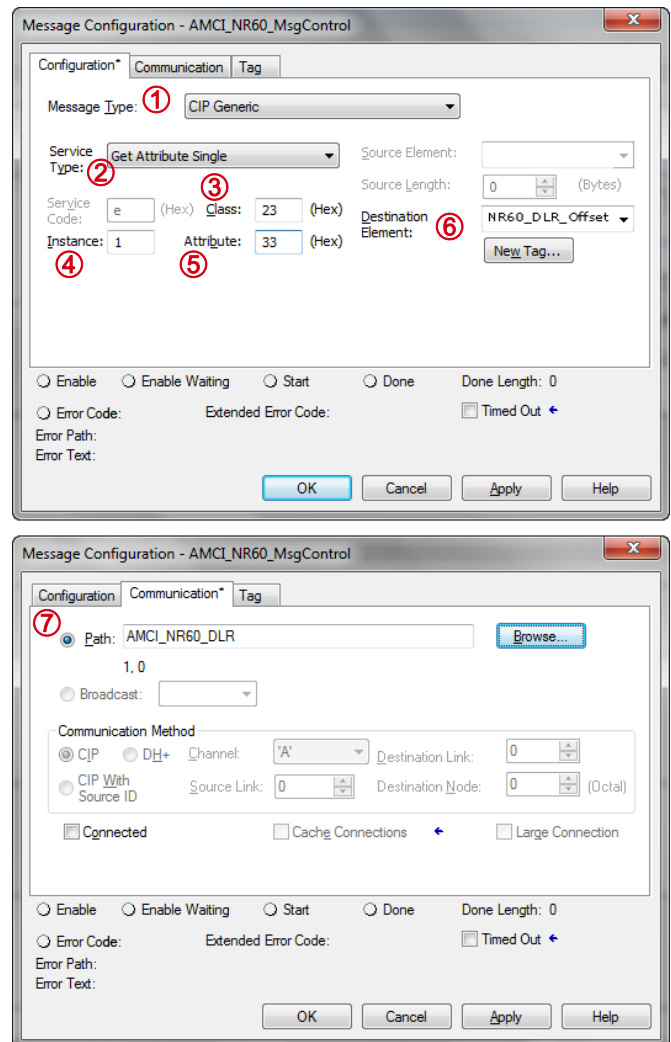

Figure 5.2 Studio 5000 MSG Example

### 5.3 Configure Explicit Message Instructions (Optional) (continued)

Table 5.4 shows the Position Sensor Object data fields that are typically retrieved when using the Get\_Attribute\_Single service.

The *CIP Position Sensor Object* reference, which starts on page 71, lists all of the attributes available from the Position Sensor Object.

Attribute ID	Name	Data Type	Description
16#03 (3 decimal)	Position Value	DINT	Current position value
16#18 (24 decimal)	Velocity Value	DINT	Current speed. The value is in the format specified by attribute 16#19
16#2E (46 decimal)	Alarm Flag	BOOLEAN	Indicates that an alarm error occurred: 0 = No errors 1 = Alarm Error
16#33 (51 decimal)	Offset Value	DINT	The internal position offset that is calculated after applying the Preset Value or resetting the position with the Reset Position switch on the NR60

Table 5.4 Supported Instance Attributes

- Message Type: Always set to “Custom”.
- Service Type: Always set to “Get\_Attribute\_Single”.
- Class: Always set to 23<sub>hex</sub>.
- Instance: Always set to 1.
- Attribute ID: See table above. The Attribute ID is entered as hexadecimal number.

The Data Type column in table shows the format that will be returned by the message instruction. The destination tag must be able to support this data format.

# Studio 5000 TASK

## WRITING DATA TO THE NR60

The easiest method for writing data to the NR60 is through explicit messaging. The NR60 supports all of the CIP Position Sensor Object attributes as well as custom assembly instances that simplify configuration and control.

Studio 5000 sample code for the NR60 is available on our website, [www.amci.com](http://www.amci.com).

### 6.1 Configure Explicit Message Instructions

In addition to the custom assemble instances that are presented in this manual, the NR60 implements the Position Sensor Object as defined in revision 2 of the CIP specification. The Position Sensor Object can be used to write data to the NR60 or issue commands such as *Device Reset*.

Before adding Message Instructions to your ladder logic, you should create a control tag for each instruction. These tags must have a 'MESSAGE' data type. These tags will hold the data and control bits for the actual data transfer. Refer to your RA documentation for additional information.

Figure 5.2 shows the two configuration screens when setting up a message instruction to communicate with an NR60.

- 1) **Message Type:** Always "CIP Generic".
- 2) **Service Type:** Depends on what you are accomplishing with the instruction. Setting the Service Type to *Custom* will allow you to set the **Service Code** field. Otherwise, the Service Code will automatically update when you change the Service Type.
- 3) **Class:** Always 23<sub>hex</sub> if you have to set it yourself. Other classes are used, but they will be automatically set when you select the appropriate Service Type.
- 4) **Instance:** Depends on which command you are sending with the instruction. *This value is entered in decimal.*
- 5) **Attribute:** Depends on which operation you are accomplishing with the instruction.
- 6) **Source Element:** The data source if you are writing data down to the NR60.
- 7) **Source Length:** The length of the data you are writing down to the NR60
- 8) **Path:** Data path to the NR60. Click on the [Browse...] button and the I/O Configuration tree will appear in a browser window. Select the NR60 in the tree and click [OK]. Click [OK] in the Message Configuration screen to accept the changes.

The [Tag] tab lists the tag used to control the message instruction. This tag must have a "MESSAGE" data type.

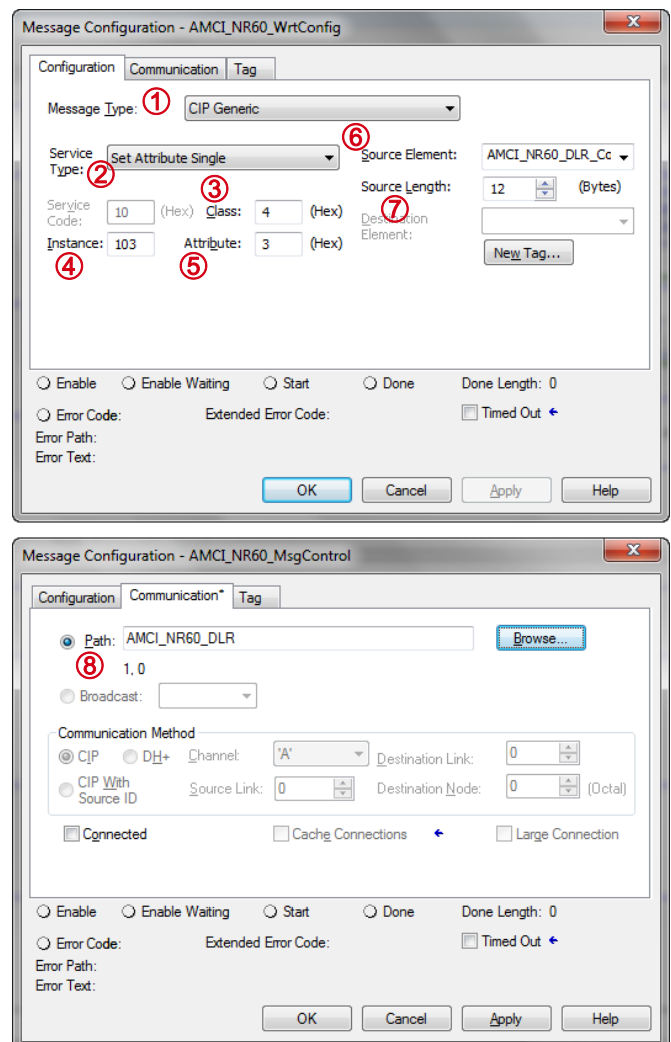

Figure 6.1 Studio 5000 MSG Example

6.2 Program Parameters Instruction

Service	Service Code	Class	Instance	Attribute	Source Length
Set_Attribute_Single	10(hex) <sup>†</sup>	4(hex)	103(dec)	3(hex)	12 bytes

<sup>†</sup> Fixed when service set to “Set\_Attribute\_Single”.

Table 6.1 Explicit Message: Program Parameters Instruction

**NOTE** This command writes parameter values to RAM. These parameter values will be lost once power is cycled to the NR60. If you wish to use these parameters after cycling power, you must issue a *Save To Nonvolatile Memory Instruction* as described on page 49.

6.2.1 Program Parameters Data Format

Twelve bytes of data must be written to the NR60 as part of this instruction. Table 6.2 lists the format of the data words. The location of these words must be entered into the message instruction using the *Source Element* field.

**NOTE** All data must be present and valid when programming the NR60. The Message Instruction will show an error code of “9” if any of the parameters are invalid. This includes the Counts per Turn parameter, which is always used to scale the velocity data. A value of zero for the Counts per Turn parameter will result in an error. If you are not using the Scaling Function Control, and you are using a Velocity Format of ‘revolutions per minute’, then set the Counts per Turn parameter to a value of 65,536. (Byte 4 = 1, Bytes 2, 3, 5 = 0).

Byte #	Word #	Parameter	Description	
0	1	Direction Counting Toggle	“0” = Clockwise increasing counts looking at shaft. “1” = Counter-Clockwise increasing counts looking at shaft.	
1		Scaling Function Control	“0” = Disable Scaling Function. The full resolution of 65,536 counts per turn is used for the Measuring Units per Span. “1” = Enable Scaling Function. The number of counts per turn is set by the Measuring Units of Span parameter below.	
2	2	Counts per Turn	Sets the number of counts generated over a single turn if the Scaling Function Control parameter equals “1”. Always sets the number of pulses per turn reported in velocity data. This value ranges from 1 to 65,536 and must be set even when the Scaling Function Control value equals zero. A value of 39,370 (16#99CA) is shown to the right.	CA
3				99
4	3			00
5				00
6	4	Total Measurement Range	Sets the number of counts before returning to zero. This value is used regardless of the state of the Scaling Function Control parameter. Parameter ranges: <ul style="list-style-type: none"> <li>➤ <b>Single Turn NR60:</b> Range of 0, 2 to 65,536</li> <li>➤ <b>28 bit Multi-turn NR60:</b> Range of 0, 2 to 268,435,456</li> <li>➤ <b>30 bit Multi-turn NR60:</b> Range of 0, 2 to 1,073,741,824</li> </ul> A value of 648,000 (16#0009 E340) is shown to the right.	40
7				E3
8	5			09
9				00
10	6	Velocity Format	Format of the velocity data. Byte 11 must always equal “1F”. Byte 10 = “04” for pulses/second, “05” for pulses/millisecond, “07” for pulses/minute or “0F” for revolutions/minute. A value of “1F04” to the right would set the unit of measure to pulses/second.	04
11				1F

Table 6.2 Program Parameters Data Format



### 6.3 Preset Position Instruction

Service	Service Code	Class	Instance	Attribute	Source Length
Set_Attribute_Single	10(hex) <sup>†</sup>	23(hex)	1(hex)	13(hex)	4 bytes

<sup>†</sup> Fixed when service set to “Set\_Attribute\_Single”.

Table 6.3 Explicit Message: Preset Position Instruction

**NOTE** This command alters the internal position offset and stores this value in RAM. This offset will be lost once power is cycled to the NR60. If you wish to save the internal position offset, you must issue a *Save To Nonvolatile Memory Instruction* as described below.

#### 6.3.1 Preset Position Data Format

Four bytes of data must be written to the NR60 as part of this instruction. Table 6.4 lists the format of the data words. The location of these words must be entered into the message instruction using the *Source Element* field.

Byte #	Word #	Description	
0	1	<b>Preset Value.</b> The value that you want the position to become when you issue this command. The Preset Value can be any number between 0 and the configured full scale count of the encoder. The values on the right show the register values in hexadecimal if the Preset Value is 704,303 (16# 000A BF2F)	2F
1			BF
2	2	The type of NR60 that you are using, as well as the Scaling Function Control and Total Measurement Range parameters affect the range of the Preset Value. See <i>Preset Value</i> on page 18 for the acceptable ranges of parameter values for the different NR60 models.	0A
3			00

Table 6.4 Preset Position Data Format

### 6.4 Save To Nonvolatile Memory Instruction

Service	Service Code	Class	Instance	Attribute	Source Length
Custom	16(hex)	23(hex)	0(hex)	0(hex)	0

Table 6.5 Explicit Message: Save to Nonvolatile Memory Instruction

This instruction saves parameter values and the internal position offset to nonvolatile memory. Additional data is not sent with this instruction. Set data length fields to 0 and leave the source field blank.

### 6.5 Restore From Nonvolatile Memory Instruction

Service	Service Code	Class	Instance	Attribute	Source Length
Custom	15(hex)	23(hex)	0(hex)	0(hex)	0

Table 6.6 Explicit Message: Restore from Nonvolatile Memory Instruction

This instruction restores parameter values to the last values saved in nonvolatile memory. Additional data is not sent with this instruction. Set data length fields to 0 and leave the source field blank.

### 6.6 Return to Factory Defaults Instruction

Service	Service Code	Class	Instance	Attribute	Source Length
Custom	5(hex)	23(hex)	0(hex)	0	0

Table 6.7 Explicit Message: Return to Factory Defaults Instruction

This instruction restores parameter values to their factory defaults. *Factory Default Settings* are listed on page 19. The Attribute field is not used and should be set to zero. Additional data is not sent with this instruction. Set data length fields to zero and leave the source field blank.

**NOTE** 

This instruction does not reset the IP Address, Network Mask, or Default Gateway parameters. See [a yet to be defined section](#) for information on changing these settings to factory defaults.

### 6.7 Reset Device Instruction

Service	Service Code	Class	Instance	Attribute	Source Length
Custom	5(hex)	1(hex)	1(hex)	0	0

Table 6.8 Explicit Message: Reset Device Instruction

This instruction forces the NR60 to perform a hardware reset. Network communications will be lost momentarily and all parameter values will be restored from nonvolatile memory. The Attribute field is not used and should be set to zero. Additional data is not sent with this instruction. Set data length fields to zero and leave the source field blank.

## ADD THE NR60 TO YOUR RSLOGIX 500 PROJECT

This section covers how to add an NR60 to your host controller when using RSLogix 500.

### 7.1 RSLogix 500 Configuration



Only RSLogix 500 version 8.0 or above can be used to configure Message Instructions to communicate with an EtherNet/IP device.

#### 7.1.1 Configure the Host Controller's Ethernet Settings

You should configure the Ethernet settings of your host controller before adding the NR60 to your project. Refer to RA documentation for information on configuring your controller.

#### 7.1.2 Create a Message Data File for each NR60

Each NR60 in the system requires its own Message (MG) data file, and the minimum number of elements in the MG file must be greater than or equal to the number of Message Instructions that reads or writes data to the particular NR60.

Right click on the Data Files icon in the project tree and select "New...". In the resulting window, change the Type field to "Message". As a minimum, set the "Elements" field to the number of Message Instructions associated with the NR60. (You can create a file that contains more elements than what is needed without causing an error.) All other fields are optional and can be left at their default settings or changed.

#### 7.1.3 Create an Extended Routing Information Data File for each NR60

Each NR60 in the system requires its own Extended Routing Information (RIX) data file, and the minimum number of elements in the RIX file must be greater than or equal to the number of Message Instructions that reads or writes data to the particular NR60.

Right click on the Data Files icon in the project tree and select "New...". In the resulting window, change the Type field to "Extended Routing Information". As a minimum, set the "Elements" field to the number of Message Instructions associated with the NR60. (You can create a file that contains more elements than what is needed without causing an error.) All other fields are optional and can be left at their default settings or changed.

***Notes***

## READING DATA FROM THE NR60

Every PLC that uses RSLogix 500 uses Message Instructions to communicate with the NR60. This is also known as explicit messaging. This chapter explains how to add message instructions to your ladder logic that allows you to read data from the NR60.

RSLogix 500 sample code for the NR60 is available on our website, [www.amci.com](http://www.amci.com).

**PREREQUISITE:** RSLogix 500 TASK: *Add the NR60 to Your RSLogix 500 Project* (page 51) This task must be completed before you can add the Message Instructions that will read data from the NR60.

### 8.1 Read Using the Custom Assembly Instances

Figure 8.1 shows the configuration screen when setting up a message instruction to communicate with an NR60 device. Note that the screen will change as you enter data.

#### 8.1.1 General Tab Settings

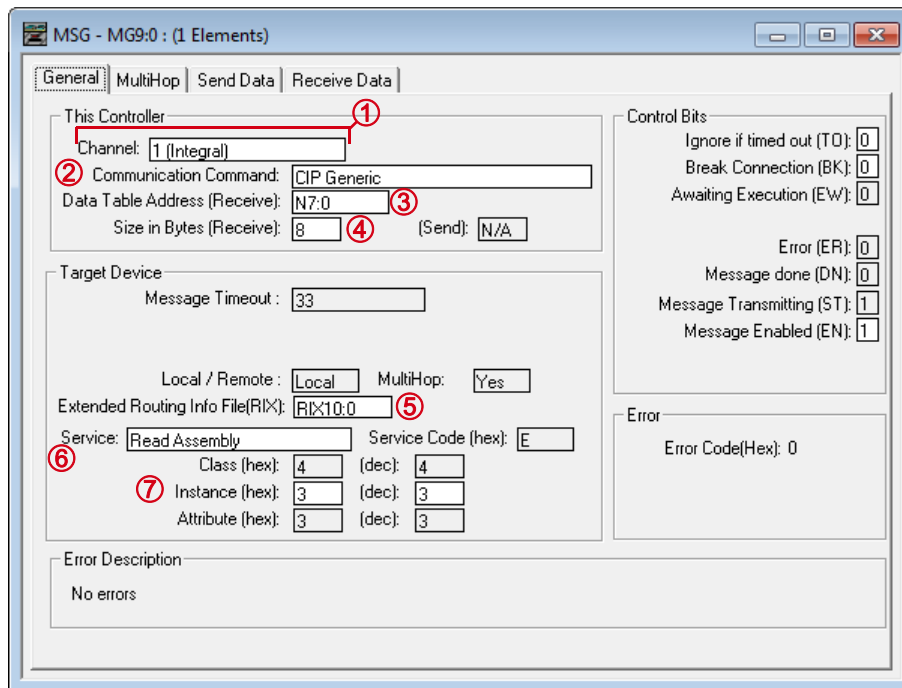

Figure 8.1 RSLogix 500 MSG Example

- 1) **Communications Channel:** Data path out of the controller. This will either be an integral port or a port on an expansion module.
- 2) **Communications Command:** Always set to “CIP Generic”.
- 3) **Data Table Address (Receive):** The starting address in memory that will be the destination of the data you are reading from the NR60. This address is typically in an Integer (N) file.
- 4) **Size in Bytes (Receive):** The length of the data you are reading from the NR60. This length is always in bytes. See table 8.1 below for a list of the available options.
- 5) **Extended Routing Info File (RIX):** Address of the RIX file you created when adding the NR60 to your project

**8.1 Read Using the Custom Assembly Instances (continued)**

- 6) **Service Field:** Double click in the Service field, select “Read Assembly” for the service type and press [Enter]. The Service Code field will change to “E”, the Class field will change to “4”, and the Attribute field will change to “3”.
- 7) **Instance:** This field controls which data is returned by the NR60 when the message instruction is executed. See table 8.1 below for a list of the available options.

**8.1.2 MultiHop Tab Settings**

Enter the IP address of the NR60 in the “To Address” field.

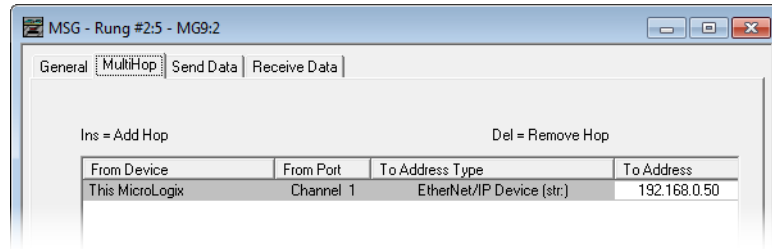

Figure 8.2 MultiHop Address Setting

**8.1.3 Available Custom Instances**

As shown in the table below, the NR60 will respond to four different message instructions when the Service Field is set to “Read Assembly”.

	Position Value Only	Position Value and Velocity Data
Instance	1 (decimal)	3 (decimal)
Size in Bytes	4 bytes	8 bytes

Table 8.1 Attributes: Explicit Read Message Instructions

**8.2 Custom Assembly Data Format**

**8.2.1 Assembly Instance = 1**

As shown in the table below, when you set the Input Assembly Instance to 1, the input data consists of the position value transferred as two 16 bit words.

Word #	Description	
0	<b>Position Value.</b> The maximum position value depends on your NR60 model and the programmed counts per turn. The maximum value in all cases is 1,073,741,823 (16#3FFF FFFF). Note that the two 16 bit registers are combined into a single 32 bit data word. The values on the right show the register values in hexadecimal if the position value is 1,274,237 (16# 0013 717D)	16#717D
1		16#0013

Table 8.2 Input Data, Position Only

## 8.2 Custom Assembly Data Format (continued)

### 8.2.2 Assembly Instance = 3

As shown in the table below, when you set the Input Assembly Instance to 3, the input data consists of the position value and velocity data transferred in a total of four 16 bit words.

Word #	Description	
0	<b>Position Data.</b> The maximum position value depends on your NR60 model and the programmed counts per turn. The maximum value in all cases is 1,073,741,823 (16#3FFF FFFF). Note that the two 16 bit registers are combined into a single 32 bit data word. The values on the right show the register values in hexadecimal if the position value is 1,274,237 (16# 0013 717D)	16#717D
1		16#0013
2	<b>Velocity Data.</b> The units of measure of the velocity data is set by the Velocity Format parameter in the Configuration Data. If the Scaling Function Control bit is ever set to a "1", the position data used to calculate the velocity data is always scaled by the Measuring Units per Span parameter. Note that the two 16 bit registers are combined into a single 32 bit data word. The values on the right show the register values in hexadecimal if the velocity value is 461,725 (16# 0007 0B9D)	16#0B9D
3		16#0007

Table 8.3 Input Data, Position and Velocity

### 8.3 Read Using the Position Sensor Object (Optional)

#### 8.3.1 General Tab Settings

In addition to the custom assemble instances presented in sections 8.1 and 8.2, the NR60 implements the Position Sensor Object as defined in revision 2 of the CIP specification. The Position Sensor Object can be used to read additional information from the NR60, such as the position offset that is presently being used to offset the actual sensor reading.

**NOTE** If one of the input assembly instances listed in sections 8.1 and 8.2 transfers all of the data you need from the device, then there is no need to use the Position Sensor Object to read data from the NR60.

Figure 8.1 shows the configuration screen when setting up a message instruction to communicate with an NR60 device using the Position Sensor Object. Note that the screen will change as you enter data.

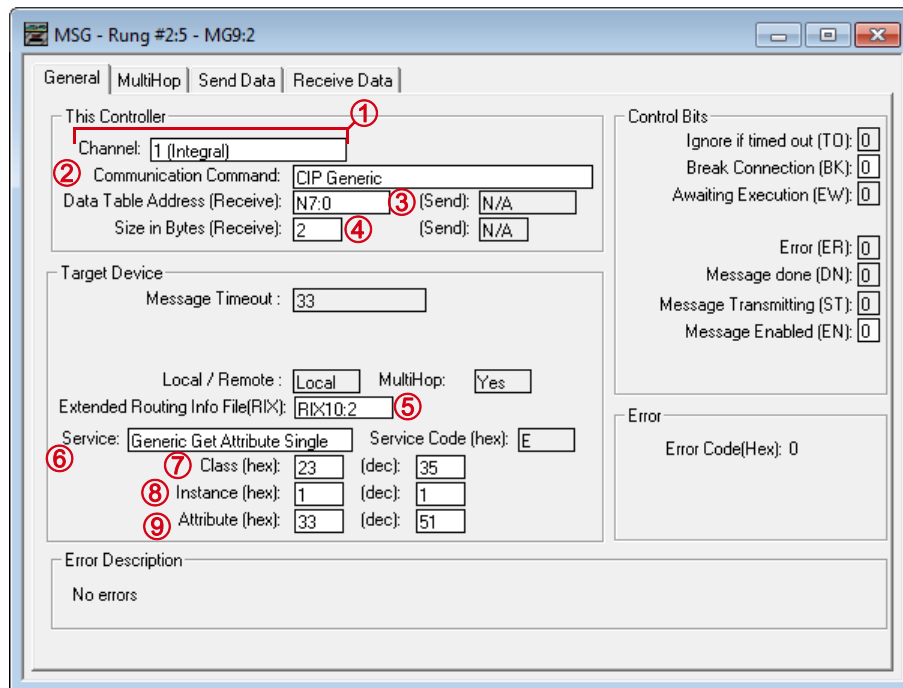

Figure 8.3 RSLogix 500 MSG Example

- 1) **Communications Channel:** Data path out of the controller. This will either be an integral port or one off of an expansion module.
- 2) **Communications Command:** Always set to “CIP Generic”.
- 3) **Data Table Address (Receive):** The starting address in memory that will be the destination of the data you are reading from the NR60. This address is typically in an Integer (N) file.
- 4) **Size in Bytes (Receive):** The length of the data you are reading from the NR60. This length is always in bytes. See table below for a list of the available options.
- 5) **Extended Routing Info File (RIX):** Address of the RIX file you created when adding the NR60 to your project
- 6) **Service Field:** Double click in the Service field, select “Generic Get\_Attribute\_Single” for the service type and press [Enter]. The Service Code field will change to “E”, the Class field will change to “4”, and the Attribute field will change to “3”.
- 7) **Class:** Set to a value of 23<sub>hex</sub>.
- 8) **Instance:** Set to a value of 1.



### 8.3 Read Using the Position Sensor Object (Optional) (continued)

#### 8.3.1 General Tab Settings (continued)

- 9) **Attribute:** This field controls which data is returned by the NR60 when the message instruction is executed. See table 8.4 below for a list of the available options.

Table 8.4 shows the Position Sensor Object data fields that are typically retrieved when using the Get\_Attribute\_Single service.

The *CIP Position Sensor Object* reference, which starts on page 71, lists all of the attributes available from the Position Sensor Object.

Attribute ID	Name	Data Type	Description
16#03 (3 decimal)	Position Value	DINT	Current position value
16#18 (24 decimal)	Velocity Value	DINT	Current speed. The value is in the format specified by attribute 16#19
16#2E (46 decimal)	Alarm Flag	BOOLEAN	Indicates that an alarm error occurred: 0 = No errors 1 = Alarm Error
16#33 (51 decimal)	Offset Value	DINT	The internal position offset that is calculated after applying the Preset Value or resetting the position with the Reset Position switch on the NR60

Table 8.4 Supported Instance Attributes

The Data Type column in table shows the format that will be returned by the message instruction. The destination data table must be able to support this data format.

#### 8.3.2 MultiHop Tab Settings

Enter the IP address of the NR60 in the “To Address” field.

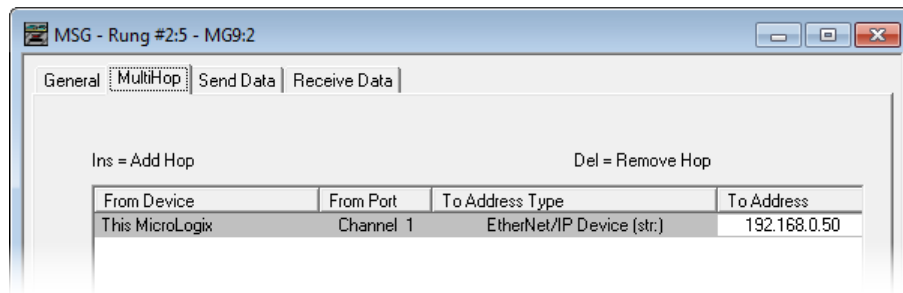

Figure 8.4 MultiHop Address Setting

***Notes***

## WRITING DATA TO THE NR60

Controllers that use RSLogix500 also use Message Instructions to write data to the NR60. The NR60 supports all of the CIP Position Sensor Object attributes as well as custom assembly instances that simplify configuration and control.

RSLogix 500 sample code for the NR60 is available on our website, [www.amci.com](http://www.amci.com).

### 9.1 Configure Explicit Message Instructions

Figure 9.1 shows the configuration screen when setting up a message instruction to communicate with an NR60 device. Note that the screen will change as you enter data.

#### 9.1.1 General Tab Settings

Figure 9.1 RSLogix 500 MSG Example

- 1) **Communications Channel:** Data path out of the controller. This will either be an integral port or a port on an expansion module.
- 2) **Communications Command:** Always set to “CIP Generic”.
- 3) **Data Table Address (Send):** The starting address in memory that will be the source of the data you are writing to the NR60. This address is typically in an Integer (N) file.
- 4) **Size in Bytes (Send):** The length of the data you are writing to the NR60. This length is always in bytes. See table 9.1 below for a list of the available options.
- 5) **Extended Routing Info File (RIX):** Address of the RIX file you created when adding the NR60 to your project

## 9.1 Read Using the Custom Assembly Instances (continued)

### 9.1.1 General Tab Settings (continued)

- 6) **Service Field:** Will be set to “Generic Set Attribute Single” or “Custom” depending on the action the message instruction will be performing. When set to “Custom” you will have to enter the required Service Code.
- 7) **Class:** The setting for this field depends on the action the message instruction will be performing.
- 8) **Instance:** The setting for this field depends on the action the message instruction will be performing.
- 9) **Attribute:** The setting for this field depends on the action the message instruction will be performing.

### 9.1.2 MultiHop Tab Settings

Enter the IP address of the NR60 in the “To Address” field.

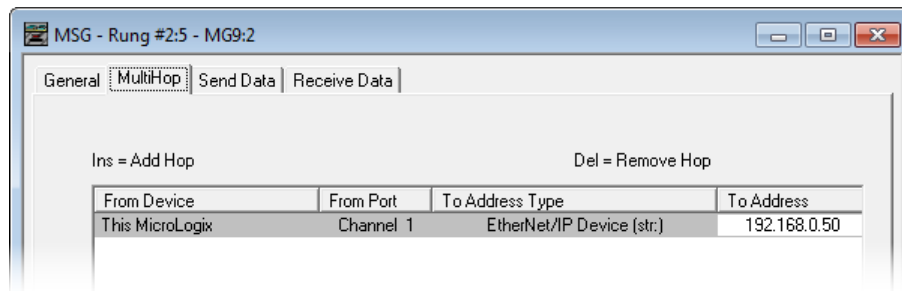

Figure 9.2 MultiHop Address Setting

## 9.2 Program Parameters Instruction

Service	Service Code	Class	Instance	Attribute	Source Length
Set_Attribute_Single	10(hex) <sup>†</sup>	4(hex)	103(dec)	3(hex)	12 bytes

<sup>†</sup> Fixed when service set to “Set\_Attribute\_Single”.

Table 9.1 Explicit Message: Program Parameters Instruction

**NOTE** This command writes parameter values to RAM. These parameter values will be lost once power is cycled to the NR60. If you wish to use these parameters after cycling power, you must issue a *Save To Nonvolatile Memory Instruction* as described on page 49.

### 9.2.1 Program Parameters Data Format

Twelve bytes of data must be written to the NR60 as part of this instruction. Table 9.2 lists the format of the data words. The location of these words must be entered into the message instruction using the *Source Element* field.

**NOTE** All data must be present and valid when programming the NR60.

Byte #	Word #	Parameter	Description	
0	1	Direction Counting Toggle	“0” = Clockwise increasing counts looking at shaft. “1” = Counter-Clockwise increasing counts looking at shaft.	
1		Scaling Function Control	“0” = Disable Scaling Function. The full resolution of 65,536 counts per turn is used for the Measuring Units per Span. “1” = Enable Scaling Function. The number of counts per turn is set by the Measuring Units of Span parameter below.	
2	2	Counts per Turn	Sets the number of counts generated over a single turn if the Scaling Function Control parameter equals “1”. Always sets the number of pulses per turn reported in velocity data. This value ranges from 1 to 65,536 and must be set even when the Scaling Function Control value equals zero. A value of 39,370 (16#99CA) is shown to the right.	CA
3				99
4				00
5	3			00
6	4	Total Measurement Range	Sets the number of counts before returning to zero. This value is used regardless of the state of the Scaling Function Control parameter. Parameter ranges: <ul style="list-style-type: none"> <li>➤ <b>Single Turn NR60:</b> Range of 0, 2 to 65,536</li> <li>➤ <b>28 bit Multi-turn NR60:</b> Range of 0, 2 to 268,435,456</li> <li>➤ <b>30 bit Multi-turn NR60:</b> Range of 0, 2 to 1,073,741,824</li> </ul> A value of 648,000 (16#0009 E340) is shown to the right.	40
7				E3
8				09
9	5			00
10	6	Velocity Format	Format of the velocity data. Byte 11 must always equal “1F”. Byte 10 = “04” for pulses/second, “05” for pulses/millisecond, “07” for pulses/minute or “0F” for revolutions/minute. A value of “1F04” to the right would set the unit of measure to pulses/second.	04
11				1F

Table 9.2 Program Parameters Data Format

### 9.3 Preset Position Instruction

Service	Service Code	Class	Instance	Attribute	Source Length
Set_Attribute_Single	10(hex) <sup>†</sup>	23(hex)	1(hex)	13(hex)	4 bytes

<sup>†</sup> Fixed when service set to “Set\_Attribute\_Single”.

Table 9.3 Explicit Message: Preset Position Instruction

**NOTE** 

This command alters the internal position offset and stores this value in RAM. This offset will be lost once power is cycled to the NR60. If you wish to save the internal position offset, you must issue a *Save To Nonvolatile Memory Instruction* as described below.

#### 9.3.1 Preset Position Data Format

Four bytes of data must be written to the NR60 as part of this instruction. Table 9.4 lists the format of the data words. The location of these words must be entered into the message instruction using the *Source Element* field.

Byte #	Word #	Description	
0	1	<b>Preset Value.</b> The value that you want the position to become when you issue this command. The Preset Value can be any number between 0 and the configured full scale count of the encoder. The values on the right show the register values in hexadecimal if the Preset Value is 704,303 (16# 000A BF2F)	2F
1			BF
2	2	The type of NR60 that you are using, as well as the Scaling Function Control and Total Measurement Range parameters affect the range of the Preset Value. See <i>Preset Value</i> on page 18 for the acceptable ranges of parameter values for the different NR60 models.	0A
3			00

Table 9.4 Preset Position Data Format

### 9.4 Save To Nonvolatile Memory Instruction

Service	Service Code	Class	Instance	Attribute	Source Length
Custom	16(hex)	23(hex)	0(hex)	0(hex)	0

Table 9.5 Explicit Message: Save to Nonvolatile Memory Instruction

This instruction saves parameter values and the internal position offset to nonvolatile memory. Additional data is not sent with this instruction. Set data length fields to 0 and leave the source field blank.

### 9.5 Restore From Nonvolatile Memory Instruction

Service	Service Code	Class	Instance	Attribute	Source Length
Custom	15(hex)	23(hex)	0(hex)	0(hex)	0

Table 9.6 Explicit Message: Restore from Nonvolatile Memory Instruction

This instruction restores parameter values to the last values saved in nonvolatile memory. Additional data is not sent with this instruction. Set data length fields to 0 and leave the source field blank.

### 9.6 Return to Factory Defaults Instruction

Service	Service Code	Class	Instance	Attribute	Source Length
Custom	5(hex)	23(hex)	0(hex)	0	0

Table 9.7 Explicit Message: Return to Factory Defaults Instruction

This instruction restores parameter values to their factory defaults. *Factory Default Settings* are listed on page 19. The Attribute field is not used and should be set to zero. Additional data is not sent with this instruction. Set data length fields to zero and leave the source field blank.

**NOTE**  This instruction does not reset the IP Address, Network Mask, or Default Gateway parameters. See the Optional Task *Resetting the IP Address of the NR60*, which starts on page 69, for information on changing these settings to factory defaults.

### 9.7 Reset Device Instruction

Service	Service Code	Class	Instance	Attribute	Source Length
Custom	5(hex)	1(hex)	1(hex)	0	0

Table 9.8 Explicit Message: Reset Device Instruction

This instruction forces the NR60 to perform a hardware reset. Network communications will be lost momentarily and all parameter values will be restored from nonvolatile memory. The Attribute field is not used and should be set to zero. Additional data is not sent with this instruction. Set data length fields to zero and leave the source field blank.

***Notes***



---

## OPTIONAL TASK

---

# INSTALL THE AMCI NET CONFIGURATOR UTILITY

---

### ***A.1 Download the AMCI Net Configurator Utility***

The AMCI Net Configurator utility is available on our website, [www.amci.com](http://www.amci.com). It can be found in our *Tech Library* section under *Product Software*. The program exists as a ZIP file.

### ***A.2 Install the AMCI Net Configurator Utility***

Once downloaded, simply extract the program from the ZIP file and run the program to install the AMCI Net Configurator utility on your computer. The software installs as most products do, giving you the option to change the file locations before installing the utility. Once the install is complete, a link to the utility is available on the Start Menu.

The install process only copies the utility to the designated location and creates links to the Start Menu. No changes are made to your registry settings.

***Notes***

## OPTIONAL TASK

# CONFIGURE YOUR NETWORK INTERFACES

### B.1 Firewall Settings

Firewalls are hardware devices or software that prevent unwanted network connections from occurring. Firewall software is present in Windows XP and above and it may prevent your computer for communicating with the NR60. Configuring your firewall to allow communication with the NR60 is beyond the scope of this manual.

AMCI strongly suggests temporarily disabling any firewall software while using the NET Configurator software. This is typically done from the Control Panel. You should enable the firewall once you have finished using the NET Configurator software.

### B.2 Disable All Unused Network Interfaces

Routing and default gateway setting on your computer can interfere with the proper operation of the NET Configurator software. The NET Configurator software uses broadcast packets to locate devices on the network, and sometimes these packets are sent out through the default gateway instead of the interface attached to the NR60. The easiest way to avoid this problem is to temporarily disable all network interfaces that are not attached to the NR60.

This includes all wireless interfaces as well as all Bluetooth interfaces.

### B.3 Configure Your Network Interface

Before you can communicate with the NR60, your network interface must be on the same subnet as the encoder.

**NOTE**  If you do not know the IP address the NR60 is presently using, use the Address Switches on the unit to set an address in the last subnet programmed into the NR60. Refer to Task 1.2b, *Use the NR60 IP Address Switches*, which starts on page 23 to set the IP Address.

**NOTE**  The rest of this procedure assumes you are using the 192.168.0.xxx subnet. If you are not, you will have to adjust the given network addresses accordingly.

The easiest way to check the current settings for your NIC is with the 'ipconfig' command.

- ▶ For Windows XP, click on the [Start] button, and click on [Run...]. A dialog box will open. Enter 'cmd' on the text line and press [Enter] on the keyboard.
- ▶ For Vista and Windows 7, click on the [Start] button, and type "cmd" in the "Search programs and files" text box. Press [Enter] on the keyboard.

**B.3 Configure Your Network Interface (continued)**

A DOS like terminal will open. Type in ‘ipconfig’, press [Enter] on the keyboard and the computer will return the present Address, Subnet Mask, and Default Gateway for all of your network interfaces. If your present address is 192.168.0.xxx, where ‘xxx’ does not equal 50, and your subnet mask is 255.255.255.0, then you are ready to configure your NR60 encoder. Figure 11.1 shows the output of an ipconfig command that shows the “Local Area Connection 2” interface on the 192.168.0.xxx subnet.

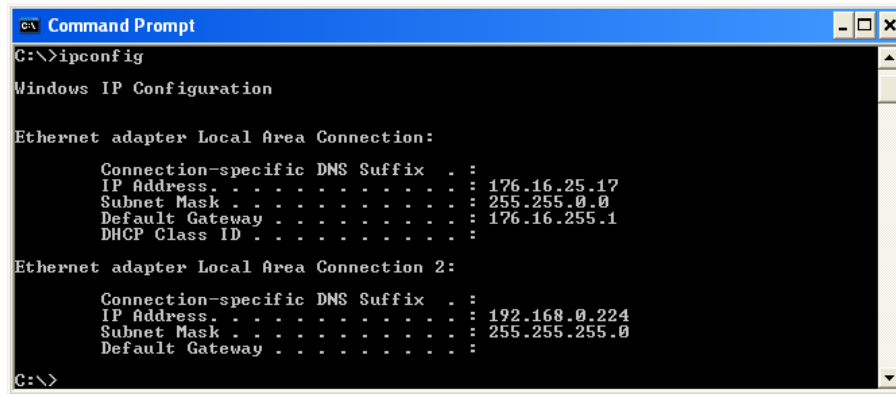

Figure 11.1 ipconfig Command

If your present address in not in the 192.168.0.xxx range, type in ‘ncpa.cpl’ at the command prompt and hit [Enter] on the keyboard.

- In XP, this opens the *Network and Dial-up Connections* window. Right click on the appropriate interface and select ‘Properties’ from the menu. This will open the *Properties* windows for the selected interface. Click on the ‘Internet Protocol (TCP/IP)’ component and then click on the [Properties] button.
- For Vista and Windows 7, this open the *Network Connections* window. Double click on the appropriate interface. In the window that opens, select “Internet Protocol Version 4 (TCP/IP v4)” from the list and then click on the [Properties] button.

Set the address and subnet mask to appropriate values. (192.168.0.1 and 255.255.255.0 will work for an NR60 that has factory default settings.) The default gateway and DNS server settings can be ignored.

## OPTIONAL TASK

# RESETTING THE IP ADDRESS OF THE NR60

This section is intended for the engineer or technician responsible for resetting the IP address of an NR60 networked resolver encoder to a known value.

### C.1 Determine the Best Method for Resetting the IP Address

If you are using an NR60 that no longer has the factory default address settings, you may find it difficult to discover the IP address settings that are currently stored in nonvolatile memory. Two methods are available for resetting the IP address to a known value.

Method	Restrictions	Starting page
<i>Use a DHCP Server</i>	The NR60 is fully compatible with the DHCP protocol. Setting the NR60 Address Switches to 000 enables the DHCP client. Once an address has been accepted over DHCP, the NR60 will save the address in nonvolatile memory and use this stored address if DHCP is later disabled.	See Below
<i>Use the AMCI Net Configurator Utility</i>	Setting the NR60 Address Switches to 999 forces the NR60 to use the default IP address of 192.168.0.50. Once connected using this address, the software can be used to set the NR60 to any IPv4 address. The IP address will be stored in nonvolatile memory and used on subsequent power-ups. The software can also be used later to configure the parameters of the NR60.	See Below

Table 12.1 Methods for Resetting the IP Address

### C.2 Use a DHCP Server

The procedure used in Task 1.2c, *Use a DHCP Server*, can be followed without modification. This procedure starts on page 24.

### C.3 Use the AMCI Net Configurator Utility

The procedure used in Task 1.2d, *Use the AMCI NET Configurator Utility*, can be used with the following modifications:

**PREREQUISITE:** The IP Address Switches must be set to a value of 999. Task 1.2a: *Use Factory Default Settings*, can be used to verify switch settings. This procedure starts on page 22.

**PREREQUISITE:** Task 3: *Wire Power and Ethernet* (page 35) This task must be completed before the AMCI NET Configurator utility can be used to set the IP address.

**PREREQUISITE:** Optional Task A: *Install the AMCI NET Configurator Utility* (page 65) The AMCI NET Configurator utility must be installed on a computer before it can be used.

**PREREQUISITE:** Optional Task B: *Configure Your Network Interfaces*. (page 67) The network interfaces on your computer must be correctly configured before you can communicate with an NR60 encoder. The address of your computer must be in the 192.168.0.xxx subnet, and its address cannot be 192.168.0.50.

Once these prerequisites are met, you can start the procedure at step 1.2d.1 *Verify that Your Host Controller is Disconnected from the NR60*, which starts on page 27. Follow the procedure until it is completed.

***Notes***

## CIP POSITION SENSOR OBJECT

### **Common Industrial Protocol**

EtherNet/IP is a protocol stack that implements the Common Industrial Protocol (CIP) over Ethernet using TCP/IP. The CIP is sponsored by the Open DeviceNet Vendors Association (ODVA) and is implemented over a variety of networks. The NR60 follows the Encoder Device Profile that is defined in the CIP specification. The Configuration and Programming instances explained in chapters 4 and 5 are actually custom instances that simplify configuring and programming the encoder when using implicit messaging.

In addition to these custom instances, the NR60 implements the Position Sensor Object, which is a mandatory object for every product that implements the Encoder Device Profile as defined in the specification. The explicit messages that are used to preset the position value and save the programmed parameters are two commands defined in the Position Sensor Object.

The NR60 implements the CIP revision 2 definition of the Position Sensor Object.

**NOTE**  Using the Position Sensor Object to communicate with the NR60 is *completely optional*. Most applications should communicate with the NR60 using the custom instances as explained in the previous two chapters because it will greatly simplify your PLC programming. The only reasons to use the Position Sensor Object is if you need extremely fine grain control over communications with the NR60 or if you use EtherNet/IP encoders from multiple vendors and you decide to write code that can be used with any of these sensors.

### **Supported Services**

The following table lists the common services implemented by the NR60 for the Position Sensor Object.

Service Code	Implemented		Service Name	Description of Service
	Class	Instance		
16#05	Yes	No	Reset	Resets all parameter values to the factory default
16#0E	Yes	Yes	Get_Attribute_Single	Returns the contents of the specified attribute
16#10	No	Yes	Set_Attribute_Single	Modifies an attribute value
16#15	Yes	No	Restore	Restores all parameter values from nonvolatile storage
16#16	Yes	No	Save	Saves all programmable parameters to the nonvolatile storage including the position offset derived from setting the Preset Value, (Attribute 16#13)

The services that are implemented only on the Class level (not on the Instance) should address Instance 0.

Table 13.1 Supported Services

- Service Code 16#0E, *Get\_Attribute\_Single* is used to read data from the Position Sensor Object class.
- Service Code 16#10, *Set\_Attribute\_Single* is used to write data to the Position Sensor Object class.

**Supported Instance Attributes**

Table 13.3 on the following two pages lists all of instance attributes implemented by the NR60. Table 13.2 below describes the Data Type values used in this table.

Data Type	Length	Description
BOOLEAN	8 bits	Holds single on/off (true/false) value
BYTE	8 bits	Holds up to 8 bits of data which should not be considered to be a scalar value
USINT	8 bits	Unsigned 8 bit value
WORD	16 bits	Holds up to 16 bits of data which should not be considered to be a scalar value
UINT	16 bits	Unsigned 16 bit integer value
DINT	32 bits	Signed 32 bit integer value
UDINT	32 bits	Unsigned 32 bit integer value

Table 13.2 Explanation of Data Types

**NOTE** When programming these instances, always use a Class Code of 16#23.

Attrib. ID	Access	Name	Data Type	Description
16#01 - 1	Get	Number of Attributes	USINT	Number of supported Attributes = 21
16#02 - 2	Get	Attribute List	Array of BYTE	List of supported Attributes = 01, 02, 0A, 0B, 0C ...71hex
16#03 - 3	Get	Unsigned Position Value	UDINT	Current position value
16#0B - 11	Get	Position Sensor Type	WORD	Specifies the device type 1 = Single turn absolute rotary encoder 2 = Multi-turn absolute rotary encoder
16#0C - 12	Set	Direction Counting Toggle	BOOLEAN	Controls the counting direction: 0 = CW 1 = CCW
16#0E - 14	Set	Scaling Function Control	BOOLEAN	Enables Scaling function 0 = OFF (65,536 counts per turn) 1 = ON (Scaling set by <i>Measuring Units per Span</i> , attribute 10hex)
16#10 - 16	Set	Measuring Units per Span (Counts per Turn)	UDINT	Resolution for one revolution: 1 to 65,536 counts per turn
16#11 - 17	Set	Total Measurement Range	UDINT	Counts before roll over to zero. <b>Single Turn NR60:</b> Range of 0, 2 to 65,536 <b>28 bit Multi-turn NR60:</b> Range of 0, 2 to 268,435,455 <b>30 bit Multi-turn NR60:</b> Range of 0, 2 to 1,073,741,823
16#13 - 19	Set	Preset Value	DINT	Sets the position to the specified value. Calculates an internal offset that will be saved to the nonvolatile storage if Save service (code 16#16) is issued.
16#18 - 24	Get	Velocity Value	DINT	Current speed. The value is in the format specified by attribute 16#19

(Table is continued on next page)



**Supported Instance Attributes (continued)**

Attrib. ID	Access	Name	Data Type	Description
16#19 - 25	Set	Velocity Format	WORD	Format of the velocity attribute: 16#1F04 = pulses/s    16#1F05 = pulses/ms 16#1F07 = steps/min    16#1F0F = RPM
16#29 - 41	Get	Operating Status	BYTE	Encoder diagnostic operating status. Bit 0 = Value of attribute 16#0C (12) Bit 1 = Value of attribute 16#0E (14)
16#2A - 42	Get	Physical Resolution Span	UDINT	Physical resolution of the single-turn resolver sensor
16#2B - 43	Get	Number of Spans	UINT	Maximum number of revolutions that could be measured.
16#2C - 44	Get	Alarms	WORD	Indicates a malfunction has occurred.
16#2D - 45	Get	Supported Alarms	WORD	Information about supported alarms
16#2E - 46	Get	Alarm Flag	BOOLEAN	Indicates that an alarm error occurred: 0 = No errors 1 = Alarm Error
16#33 - 51	Get	Offset Value	DINT	The internal position offset that is calculated after applying the Preset Value through attribute 13hex (19)

Table 13.3 Supported Instance Attributes

**NOTE**  For detailed description of the Attributes, see the CIP definition.

**Supported Alarms**

The NR60 supports the following operational alarm.

- Diagnostic Error

This alarm is set when the NR60 fails its power up diagnostics. The Position Error alarm is also set to indicate that the position data may be incorrect.

Attributes 16#2D, *Supported Alarms*, 16#2C, *Alarms*, and 16#2E *Alarm Flag* indicate something about the alarms supported by the NR60.

- **16#2D: Supported Alarms** – Reading this attribute returns a value of 3, indicating that the Position Error alarm and Diagnostic Error alarms are both used.
- **16#2C: Alarms** – Reading this attribute will return a value of zero if no alarms have occurred and a value of three if an alarm has occurred.
- **16#2E: Alarm Flag** – Reading this attribute will return a value of zero if no alarms have occurred and a value of one if an alarm has occurred.



***ADVANCED MICRO CONTROLS INC.***

20 GEAR DRIVE, TERRYVILLE, CT 06786 T: (860) 585-1254 F: (860) 584-1973

[www.amci.com](http://www.amci.com)

---



***Waste Electrical and Electronic Equipment (WEEE)***

At the end of life, this equipment should be collected separately from any unsorted municipal waste.