

# 7361 SSI Interface Module

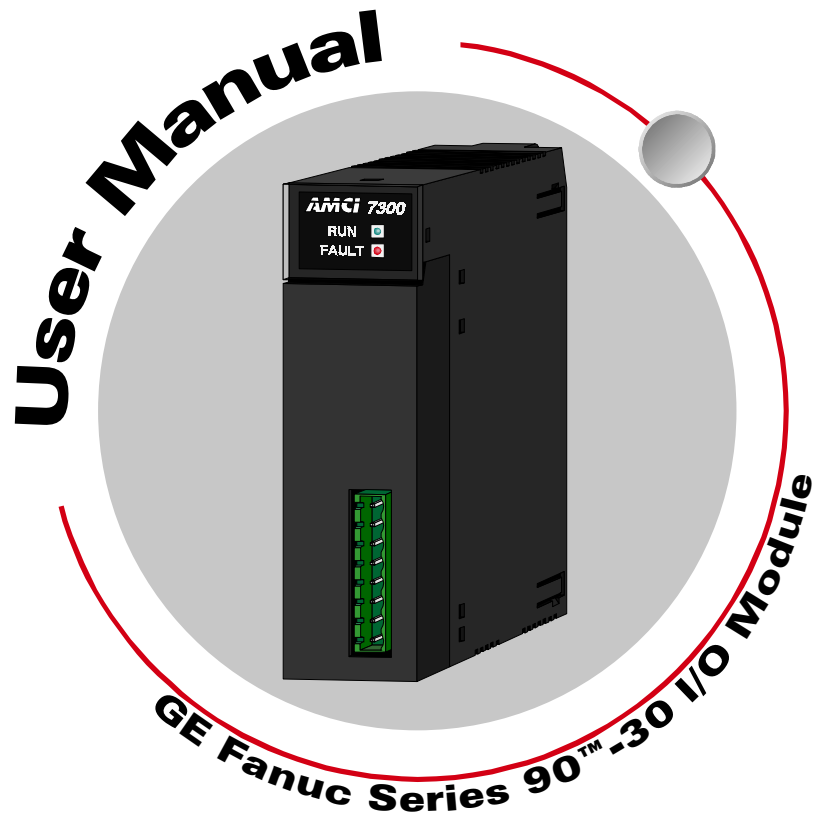

# GENERAL INFORMATION

## **Important User Information**

The products and application data described in this manual are useful in a wide variety of different applications. Therefore, the user and others responsible for applying these products described herein are responsible for determining the acceptability for each application. While efforts have been made to provide accurate information within this manual, AMCI assumes no responsibility for the application or the completeness of the information contained herein.

UNDER NO CIRCUMSTANCES WILL ADVANCED MICRO CONTROLS, INC. BE RESPONSIBLE OR LIABLE FOR ANY DAMAGES OR LOSSES, INCLUDING INDIRECT OR CONSEQUENTIAL DAMAGES OR LOSSES, ARISING FROM THE USE OF ANY INFORMATION CONTAINED WITHIN THIS MANUAL, OR THE USE OF ANY PRODUCTS OR SERVICES REFERENCED HEREIN.

No patent liability is assumed by AMCI, with respect to use of information, circuits, equipment, or software described in this manual.

The information contained within this manual is subject to change without notice.

This manual is copyright 2001 by Advanced Micro Controls Inc. You may reproduce this manual, in whole or in part, for your personal use, provided that this copyright notice is included. You may distribute copies of this complete manual in electronic format provided that they are unaltered from the version posted by Advanced Micro Controls Inc. on our official website: [www.amci.com](http://www.amci.com). You may incorporate portions of this documents in other literature for your own personal use provided that you include the notice "Portions of this document copyright 2001 by Advanced Micro Controls Inc." You may not alter the contents of this document or charge a fee for reproducing or distributing it.

## **Standard Warranty**

ADVANCED MICRO CONTROLS, INC. warrants that all equipment manufactured by it will be free from defects, under normal use, in materials and workmanship for a period of [1] year. Within this warranty period, AMCI shall, at its option, repair or replace, free of charge, any equipment covered by this warranty which is returned, shipping charges prepaid, within one year from date of invoice, and which upon examination proves to be defective in material or workmanship and not caused by accident, misuse, neglect, alteration, improper installation or improper testing.

The provisions of the "STANDARD WARRANTY" are the sole obligations of AMCI and excludes all other warranties expressed or implied. In no event shall AMCI be liable for incidental or consequential damages or for delay in performance of this warranty.

## **Returns Policy**

All equipment being returned to AMCI for repair or replacement, regardless of warranty status, must have a Return Merchandise Authorization number issued by AMCI. Call (860) 585-1254 with the model number and serial number (if applicable) along with a description of the problem. A "RMA" number will be issued. Equipment must be shipped to AMCI with transportation charges prepaid. Title and risk of loss or damage remains with the customer until shipment is received by AMCI.

## **24 Hour Technical Support Number**

24 Hour technical support is available on this product. For technical support, call (860) 583-7271. Your call will be answered by the factory during regular business hours, Monday through Friday, 8AM - 5PM EST. During non-business hours an automated system will ask you to enter the telephone number you can be reached at. Please remember to include your area code. The system will page one of two engineers on call. Please have your product model number and a description of the problem ready before you call.

## **We Want Your Feedback**

Manuals at AMCI are constantly evolving entities. Your questions and comments on this manual are both welcomed and necessary if this manual is to be improved. Please direct all comments to: Technical Documentation, AMCI, 20 Gear Drive, Terryville CT 06786, or fax us at (860) 584-1973. You can also e-mail your questions and comments to [techsupport@amci.com](mailto:techsupport@amci.com)

# TABLE OF CONTENTS

## **GENERAL INFORMATION**

Important User Information .....	IFC
Standard Warranty .....	IFC
Returns Policy .....	IFC
24 Hour Technical Support Number .....	IFC
We Want Your Feedback .....	IFC

## **About This Manual**

Audience .....	3
Navigating this Manual .....	3
Manual Conventions .....	3
Trademark Notices .....	4
Revision Record .....	4
Revision History .....	4
Where To Go From Here .....	4

## **Chapter 1: Introducing the 7361**

Overview .....	5
Unit Description .....	6
Status LED's .....	6
Transducer Input Connector .....	6
External Power Supply .....	6
Compatible Transducers .....	7
Other AMCI 90-30 Products .....	7
Other Products from AMCI .....	7

## **Chapter 2: Quick Start**

Get Familiar with the 7361 .....	9
Decide On Needed Functionality .....	9
Determine Parameter Values .....	9
Install Your Hardware .....	10
Configure Your Software .....	10
Add Ladder Logic to Program the 7361 .....	10
Load Programming Data into the 90-30 Registers .....	11
Verify and Fine Tune Your System ....	11

## **Chapter 3: System Checkout**

Needed Equipment .....	13
Install the Modules in the Baseplate .....	13
Wire the Transducer Cable (optional) .....	13
Attach the PC to the Processor .....	14
Apply Power .....	14
Create a New Project .....	14
Configure the 7361's Slot .....	14
Add Ladder Logic .....	14
Set Register Values .....	16
If You Don't Have a Transducer ..	16
If You Do Have a Transducer .....	16
Download the Program and Switch to Run Mode .....	17
Initiate a Programming Cycle .....	17
Monitor Data Value .....	17
Preset the Data Value .....	17

## **Chapter 4: Specifications**

Required External Supply .....	20
Transducer Cabling .....	20
Compatible Transducers .....	20
SSI Protocol Overview .....	20
Programmable Parameters .....	21
SSI Setup Parameters .....	21
SSI Clock Frequency .....	21
Number of Data Bits & MSB Number Parameters .....	21
Data Type .....	21
Data Logic .....	21
Data Setup Parameters .....	22
Scalar Multiplier & Scalar Divisor .....	22
Preset Value .....	23
Count Direction .....	23
Rate Update Time .....	23
Backplane Programming .....	24
Programming Cycle .....	24
EEPROM Parameter Memory .....	24

**Chapter 5: General Installation Guidelines**

Background ..... 25

Surge (EMI) Suppression ..... 25

    Surge Suppression: DC Outputs ... 26

    Surge Suppression: AC Outputs ... 27

Grounding ..... 28

Wiring ..... 28

Power Supply Wattage and Filtering ..... 29

**Chapter 6: Installing the 7361**

Inserting the 7361 into the Baseplate ..... 31

    To Insert the 7361 ..... 31

    To Remove the 7361 ..... 31

Transducer Mounting ..... 31

Transducer Power Supply ..... 32

    When Using a System Supply ..... 32

    When Using a Separate Supply ... 32

Installing the Transducer Cable ..... 33

**Chapter 7: Backplane Programming**

Software Configuration ..... 35

    VersaPro Configuration ..... 35

    Logicmaster 90 Configuration ..... 36

Programming Cycle ..... 37

Order of Programming Commands ..... 37

%I and %AI Input Data Format ..... 38

    %i Status Bits ..... 38

%Q and %AQ Output Data Format ..... 39

    %Q Command Bits ..... 39

    %AQ Word 1 ..... 40

Parameter Ranges and Factory Defaults .. 40

**Chapter A: FREQUENTLY ASKED QUESTIONS**

Why does my raw SSI data equal 33,554,431 and doesn't change? ..... 41

How can I verify that my Programming Cycle code is working? ..... 41

How do I fix problems with my Data Value? ..... 41

    Data Value jumps around or appears random ..... 41

    Data Value is preset at one end of travel, and it's off at the other end 41

Why does my Data Value get corrupted and then return to normal? ..... 42

I'm using a rotary encoder. Why does the Rate of Change data occasionally spike for one scan? ..... 42

**Chapter B: Common Configurations**

Background ..... 43

MTS Temposonics III Transducers ..... 43

Balluff BTL-5 Transducers ..... 44

Sick Optic DME3000 Laser Distance Sensor ..... 44

Stegmann AG626 Encoders ..... 45

Determining Settings for an Unknown Sensor ..... 46

**Chapter C: Working With Rotary Encoders**

Definition of a Rotary Encoder ..... 47

Definition of Full Scale Count ..... 47

Ladder Logic Examples ..... 47

Reversing The Count Direction ..... 47

    Memory Needed ..... 47

    Ladder Logic ..... 48

Offsetting the Data Value ..... 48

    Memory Needed ..... 48

    Ladder Logic ..... 49

Notes on Rate Of Change Data ..... 50

# ABOUT THIS MANUAL

Read this chapter to learn how to navigate through the manual and familiarize yourself with the conventions used in it. The last section of this chapter highlights the manual's remaining chapters and their targeted audiences.

## **Audience**

This manual explains the set-up, installation, and operation of AMCI's 7361 SSI Interface Module for the GE-Fanuc Series 90™-30 PLC platform.

It is written for the engineer responsible for incorporating the 7361 into a design, as well as the engineer or technician responsible for its actual installation.

## **Navigating this Manual**

This manual is designed to be used in both printed and on-line forms. Its on-line form is a PDF document, which requires Adobe Acrobat Reader version 4.0+ to open it.

Bookmarks of all the chapter names, section headings, and sub-headings were created in the PDF file to help navigate it. The bookmarks should have appeared when you opened the file. If they didn't, press the F5 key on Windows platforms to bring them up.

Throughout this manual you will also find *green text that functions as a hyperlink* in HTML documents. Clicking on the text will immediately jump you to the referenced section of the manual. If you are reading a printed manual, most links include page numbers.

The PDF file is password protected to prevent changes to the document. You are allowed to select and copy sections for use in other documents and, if you own Adobe Acrobat version 4.05 or later, you are allowed to add notes and annotations.

## **Manual Conventions**

Three icons are used to highlight important information in the manual:



**NOTES** highlight important concepts, decisions you must make, or the implications of those decisions.



**CAUTIONS** tell you when equipment may be damaged if the procedure is not followed properly.



**WARNINGS** tell you when people may be hurt or equipment may be damaged if the procedure is not followed properly.

The following table shows the text formatting conventions:

Format	Description
Normal Font	Font used throughout this manual.
<i>Emphasis Font</i>	Font used the first time a new term is introduced.
<i>Cross Reference</i>	When viewing the PDF version of the manual, clicking on the cross reference text jumps you to referenced section.

## Trademark Notices

The AMCI logo is a trademark, and “AMCI” and “DuraCoder” are registered trademarks of Advanced Micro Controls Inc. “System 90”, “Logicmaster”, and “VersaPro” are trademarks of GE-Fanuc Automation North America, Inc. “Adobe” and “Acrobat” are registered trademarks of Adobe Systems Incorporated.

All other trademarks contained herein are the property of their respective holders.

## Revision Record

This manual, 940-03010, is the first revision of the manual. It was initially released March 6<sup>th</sup>, 2002.

### Revision History

940-03010: 3/6/2002. Initial Release.

## Where To Go From Here

This manual contains information that is of interest to everyone from engineers to operators. The table below gives a brief description of each chapter’s contents to help you find the information you need to do your job.

CHP Num.	Chapter Title	Intended Audience
1	<i>INTRODUCING THE 7361</i>	Anyone new to the 7361. This chapter gives a basic overview of the features available on the unit, typical applications, and complementary equipment.
2	<i>QUICK START</i>	Anyone already experienced in installing or using similar products and wants generalized information to get up and running quickly.
3	<i>SYSTEM CHECKOUT</i>	A bench test procedure to help you get familiar with the 7361.
4	<i>SPECIFICATIONS</i>	Anyone that needs detailed information on the 7361 including electrical specifications and an explanation of its programmable parameters.
5	<i>GENERAL INSTALLATION GUIDELINES</i>	Anyone new to installing electronic controls in an industrial environment. The chapter includes general information on grounding, wiring, and surge suppression that is applicable to any controls installation.
6	<i>INSTALLING THE 7361</i>	Anyone that must install a 7361. Includes information on mounting, grounding, and wiring specific to the unit.
7	<i>BACKPLANE PROGRAMMING</i>	Anyone that must develop the ladder logic to read and write data to the 7361.
APX A	<i>FREQUENTLY ASKED QUESTIONS</i>	Anyone responsible for trouble shooting or fine tuning the performance of the 7361 once it’s installed.
APX B	<i>COMMON CONFIGURATIONS</i>	Anyone who must program the 7361 and is looking for parameter values for the most common SSI transducers.
APX C	<i>WORKING WITH ROTARY ENCODERS</i>	Anyone who is programming the 7361 to work with a rotary SSI encoder.

## INTRODUCING THE 7361

This chapter is written for anyone that wants to familiarize themselves with the features of the 7361, the types of applications it was designed for, and other products from AMCI for GE-Fanuc's 90-30 platform.

### Overview

Utilizing licensed GE-Fanuc 90-30 I/O interface technology, the one slot 7361 SSI interface module plugs directly into the 90-30 baseplate and accepts a single SSI transducer. The 7361 module reads and scales the data from any SSI transducer and also calculates the data's rate of change. The meaning of the *Data Value* and *Rate Of Change* information depends on the type of transducer attached to the 7361. An SSI pressure sensor reports a pressure value and the 7361 calculates the pressure change per second. An SSI position sensor reports a position value and the 7361 calculates the position change per second, which is the velocity, of the moving part.

One type of SSI transducer the 7361 can interface with is the linear displacement transducer (LDT). LDT's are non-contact, absolute, linear measurement devices that offer high resolution and accuracy. The transducer tracks the absolute position of a magnet along its waveguide. LDT's can be manufactured with a waveguide length from 2 to 300 inches. There are two major manufacturers of SSI linear displacement transducers, Balluff and MTS. Presently, Balluff BTL-5 transducers offer a resolution and repeatability of up to 5  $\mu\text{m}$  (0.0002") and an accuracy of up to  $\pm 30 \mu\text{m}$  ( $\pm 0.0012$ "). MTS Temposonics III transducers offer a resolution and repeatability of up to 5  $\mu\text{m}$  (0.0002") and an accuracy of up to 50  $\mu\text{m}$  (0.002").

"SSI" stands for Synchronous Serial Interface, and the standard defines a serial data stream from the transducer that is synchronized to clock pulses generated by the controller. The formal SSI protocol defines a data length of twenty-four bits followed by a twenty-fifth "stop" bit. However, AMCI is aware of some transducers that use the twenty-fifth bit to transmit data. To accommodate these devices, AMCI reports the twenty-fifth bit as data.

Physically, the 7361 module is a single slot module that accepts a single SSI transducer and requires an external 24Vdc power supply. In addition to the eight pin Transducer Input Connector, the front panel has two LED's that show the modules' status.

The 7361's *Programmable Parameters* define where the SSI data is embedded in the bit stream and gives you the ability to scale this data. For example, assume that you are using a Balluff LDT that gives you one count per 20  $\mu\text{m}$ . You can use the 7361 to scale this value to one count per 0.001 inch. The calculated Rate of Change is scaled to the same units as the Data Value. To continue the example, the Rate of Change (velocity) is scaled thousandths of an inch per second. All parameter values are stored in non-volatile EEPROM memory.

Along with the scaled Data Value and Rate of Change information, the 7361 reports the actual SSI data to the 90-30 processor. This gives you the ability to use ladder logic to check the SSI data for any additional information that it may contain, such as error bits.



Figure 1.1 7361 Module





## Unit Description

As you can see in figure 1.1 on the previous page, the module is very simple. There are two Status LED's on the top and the Transducer Input Connector on the bottom. The SSI transducer and its external supply wire into the Transducer Input Connector.

AMCI purchases the plastic case, the baseplate connector, and the baseplate interface IC directly from GE Fanuc under license. These are the same components used by every other GE Fanuc intelligent 90-30 module, so the 7361 is 100% mechanically and electrically compatible with the 90-30 baseplate.

### Status LED's

The two Status LED's allow you to quickly verify the operating status of the module.

- **RUN** – This green LED is on when the module is operational.
- **FAULT** – This red LED is on when there is a module fault.

If you have a module fault, then you'll have to look at the module's %I bits to determine the error. If the problem is a EEPROM fault, then you can clear it from the backplane. For any other problem you will have to cycle power. If the error still exists, the module must be repaired.

If you are familiar with our 7351 LDT Interface Module, then be aware that the 7361 cannot detect a transducer fault like the 7351 can. This is because the 7361 treats all twenty-five SSI bits as data and cannot distinguish when a fault condition exists. Appendix A, *FREQUENTLY ASKED QUESTIONS*, which starts on page 41, gives helpful tips on determining when a transducer fault may exist by checking the raw SSI data transmitted by the module.

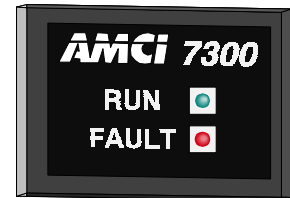

Figure 1.2 Status LED's

### Transducer Input Connector

Figure 1.3 shows the pinout of the Transducer Input Connector. The mating connector, which is included with the 7361, is not shown. The external 24Vdc supply that powers the transducer must also be wired to pins one and two of this connector to power the module's internal opto-couplers. A wiring diagram for the connector is given in chapter 4, in the *Installing the Transducer Cable* section starting on page 33. The figure also gives color codes for the Balluff and MTS cables.

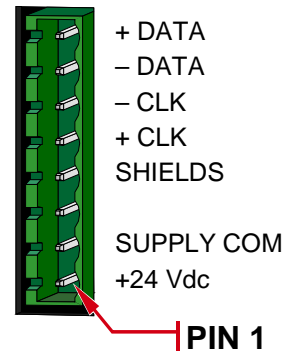

Figure 1.3 Transducer Input Connector

### External Power Supply

The external supply powers the SSI transducer and the 7361's opto-couplers. Therefore, the size of the supply depends on the transducer you're using. You can use the supply for more than one transducer. However, verify that the power supply common will be isolated from the body of each transducer. This check is to verify that the supply common is isolated from earth ground. Local safety codes may require you to ground the power supply common at one point, but if you tie it to earth ground at each transducer, you will most likely create a ground loop problem that will affect reliable operation and may even damage the transducers or modules.

You can also use a system supply for the transducer. (A system supply provides 24Vdc for the entire machine.) If you go this route, then you must have surge suppression devices on all inductive loads attached to the supply such as relays, motor contactors, solenoids, etc. This lowers the possibility of SSI data corruption by limiting the amount of EMI "noise" generated by these inductive devices.

Further information on installation the 7361 can be found in chapters 5: *GENERAL INSTALLATION GUIDELINES*, and 6: *INSTALLING THE 7361*, starting on page 25.





## Compatible Transducers

The 7361 is compatible with any transducer that outputs serial data using the SSI protocol. The module has been tested with Balluff BTL-5 and MTS Temposonics III linear displacement transducers, Stegmann optical encoders, and SICK optical distance sensors.

Note that the 7361 does not support multi-word SSI transfers. Even though the formal SSI definition includes the multi-word transfer, it is rarely used in actual applications.

## Other AMCI 90-30 Products

AMCI has a complete line of resolver and LDT interface modules for the GE Fanuc 90-30 platform. Table 1.1 lists these single-slot modules. Additional information on these products can be found on our website, [www.amci.com](http://www.amci.com).

Model Number	Transducer Interface	Description
1331	Resolver	Interfaces one (1) single-turn resolver to the 90-30 baseplate. The position data can be scaled to any value between 2 and 1,024 counts per turn. The module also allows you to preset the position to any value within its range. It reports position and velocity data over the backplane.
1332	Resolver	Interfaces two (2) single-turn resolvers to the 90-30 baseplate. With specifications otherwise identical to the 1331, the two resolvers are completely independent, with separate programmable parameters for each transducer.
1341	Resolver	Interfaces one (1) single-turn resolver to the 90-30 baseplate. With the exception of being able to scale its position data to any value between 2 and 8192, the 1341 is identical to the 1331.
1342	Resolver	Interfaces one (2) single-turn resolver to the 90-30 baseplate. With the exception of being able to scale its position data to any value between 2 and 8192, the 1342 is identical to the 1332.
1361	Multi-turn Resolver	Resolvers are absolute over a single turn. By gearing two resolvers in a single package, it is possible to encode multiple turns. The 1361 interfaces with AMCI's multi-turn transducers and offers a position resolution of 2 to 4,096 counts per turn over 180 turns. (737,280 counts max.) The 1361 also accepts AMCI transducers that encode up 1,800 turns at a maximum resolution of 409.6 counts per turn.
7351	LDT	The 7351 interfaces with Linear Displacement Transducers from MTS and Balluff as well as other manufacturers. Transducers can be of any length and maximum position resolution is 0.001 inches. The module interfaces with both $\pm 15$ Vdc and +24Vdc transducers.

Table 1.1 Other 90-30 Products

## Other Products from AMCI

AMCI has been serving the industrial automation sector since 1985, and we have a broad range of other products that are used in the marketplace.

- **RESOLVER TRANSDUCERS:** AMCI is the only company in the market place to manufacturer its own resolvers. Not only do we make the resolvers for our own products, we also produce resolvers with different electrical specifications for other position feedback applications such as servo control.
- **DURACODERS:** Absolute, Analog, or Incremental encoders that replace the fragile glass disk and sensitive optics with an industrial resolver. The size 25 DuraCoders are drop in replacements for similar sized optical encoders.
- **PLC PLUG-IN MODULES:** AMCI offers a broad range of PLC plug-in modules for most major PLC brands including GE Fanuc 90-70 and 90-30, A-B ControlLogix, SLC500 and 1771 I/O, and Modicon Quantum. Modules include resolver, LDT, and SSI interfaces, programmable limit switches, and registration control modules.



### ***Other Products from AMCI (continued)***

- **STEPPER MOTION:** Our line of stepper products include motors, drives, and indexers. Stepper motor systems offer low cost motion control for many applications.
- **GENESIS:** Genesis is our category of stand-alone controllers for machines that don't require the complexity or cost of a PLC. Using the latest in microprocessor technology, these units offer advanced features for any application, with some units having features specifically for the packaging or press control markets.
- **NEXUS:** Nexus is AMCI's broad category of products that communicate over distributed networks. This is AMCI's fastest growing category, with new products, such as stepper controllers, under constant development. Present products include resolver, LDT and SSI transducer interfaces, resolver and encoder based programmable limit switches, stepper motor indexers and drives, and press shut-height controllers. Presently we support ProfiBus, Ethernet IP and ControlNet networks.

For additional information on these items and the rest of our product lines, browse through our website [www.amci.com](http://www.amci.com), or contact AMCI or your local AMCI distributor.

# CHAPTER 2

## QUICK START

This chapter is written for anyone already familiar with installing similar products and is looking for information to get up and running quickly. It assumes you are an experienced user, with a solid understanding of the 90-30 as well as proper installation techniques such as wiring, grounding, and surge suppression.

This chapter also contains references to other sections in this manual where more information can be found. If you don't feel you have enough information or background to complete the steps listed here, *always read the referenced sections before attempting to complete a step.*

### NOTE

An SSI transducer doesn't have to be a position sensor. For example, it can be a pressure sensor or a radiation sensor. Because of this, AMCI uses the generic terms *Data Value* and *Rate of Change* throughout this manual. *Data Value* is what you read from the transducer and *Rate of Change* is how fast the Data Value is changing. (Rate of Change is calculated by the 7361.) However, we recognize that a majority of users are sensing position. In this case, Data Value is the transducer position, and Rate of Change is the velocity.

### STEP 1: Get Familiar with the 7361

- 1.1) Chapter 4, **SPECIFICATIONS**, and chapter 7, **BACKPLANE PROGRAMMING**, contain all of the information you'll need to know to program the module.
- 1.2) Chapter 3, **SYSTEM CHECKOUT** walks you through a bench test of the 7361.
- 1.3) If you're using a rotary encoder, check out Appendix C, **WORKING WITH ROTARY ENCODERS**, starting on page 47 for some helpful information.

### STEP 2: Decide On Needed Functionality

- 2.1) Do you need to scale the Data Value (position) from the transducer?
- 2.2) Do you need the Rate of Change (velocity) information?
- 2.3) Will you need to preset the Data Value?
- 2.4) Will you need to determine if the transducer is attached to the 7361 or extract error bits from the SSI data stream?
- 2.5) Will you use a separate 24Vdc power supply for the transducer, or are you going to use a system supply?

### STEP 3: Determine Parameter Values

As covered in chapter 4, AMCI breaks the 7361's programmable parameters into two groups, *SSI Setup Parameters* and *Data Setup Parameters*. SSI Setup Parameters define SSI clock frequency as well as the placement and format of the Data Value in the raw SSI data. The Data Setup Parameters scale and offset the Data Value before it is transmitted to the processor.

Descriptions of the Programmable Parameters are given in chapter 4, **SPECIFICATIONS**, starting on page 19.

- 3.1) Determine your SSI Setup Parameters. In general, an SSI clock frequency of 125 KHz will work for all applications. For other SSI Setup parameters, refer to Appendix B, **COMMON CONFIGURATIONS**, starting on page 43. This appendix gives parameter values for most common SSI transducers.
- 3.2) Determine Data Setup Parameters. In general, these values are application specific. If you are using a LDT transducer, figure 4.3, **Scalar Values for Linear Measurement Conversion** on page 22 lists the Scalar Multiplier and Scalar Divisor values for common conversions.

**STEP 4: Install Your Hardware**

- 4.1) Install your SSI transducer according to its manufacturer's guidelines.
- 4.2) The 7361 requires 230mA from the baseplate's +5Vdc power supply, (1.15 Watts), and can be installed in any free slot as long as this power requirement is met. The module installs in the baseplate like all other 90-30 modules.
- 4.3) If required, install the power supply for the transducer and 7361. If the supply is grounded, it should be to the same point as the 7361 baseplate.
- 4.4) Install the transducer cable. Figure 6.2, *7361 Transducer Input Connector*, on page 33 shows the connections for the MTS Temposonics III and Balluff BTL-5 transducers. If you're not using one of these transducers, figure 2.1 shows the pinout of the transducer connector. Refer to your transducer's installation manual for suggested cable and wire colors. Note that the mate to the transducer input connector (AMCI part # MS-8), is included with the 7361.

**NOTE**

The bottom two pins of the connector show where the 7361 accepts the external power supply. The 7361 does not generate +24Vdc on these pins.

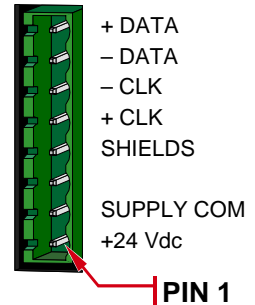

Figure 2.1 Transducer Input Connector

**STEP 5: Configure Your Software**

- 5.1) In your programming software, configure the 7361's slot as follows:
  - **Module ID:** 3
  - **%I Ref Addr:** Lowest input bit address used by the 7361. 16 bits are required.
  - **%I Size:** 16 bits
  - **%Q Ref Addr:** Lowest output bit address used by the 7361. 16 bits are required.
  - **%Q Size:** 16 bits
  - **%AI Ref Addr:** Lowest input word address used by the 7361. 6 words are required.
  - **%AI Size:** 6 words
  - **%AQ Ref Addr:** Lowest output word address used by the 7361. 6 words are required.
  - **%AQ Size:** 6 words
  - **%R Registers:** *Not used. Leave at default values.*
  - **Bytes 1-16:** *Not used. Set to zero.*

**STEP 6: Add Ladder Logic to Program the 7361**

- 6.1) Figure 2.2 on the following page is a four rung ladder logic sample that controls a *Programming Cycle* to the 7361. (Programming Cycles are used to program the 7361 from the backplane and described in the section *Programming Cycle* on page 37 of chapter 7.

The sample assumes the starting addresses of the %I, %Q, %AI, %AQ memory assigned to the 7361 all are "1". The additional memory used by the program is as follows:

- **%M1-16:** Buffers the %I data from the 7361.
- **%M17:** Setting this bit starts a Programming Cycle.
- **%R1-7:** Holds the programming data to be written to the 7361.
- **%R8-14:** Not used in this sample, but used by other sample code in this manual.
- **%R15-20:** Buffers the %AI data from the 7361.

**STEP 6: Add Ladder Logic to Program the 7361 (continued)**

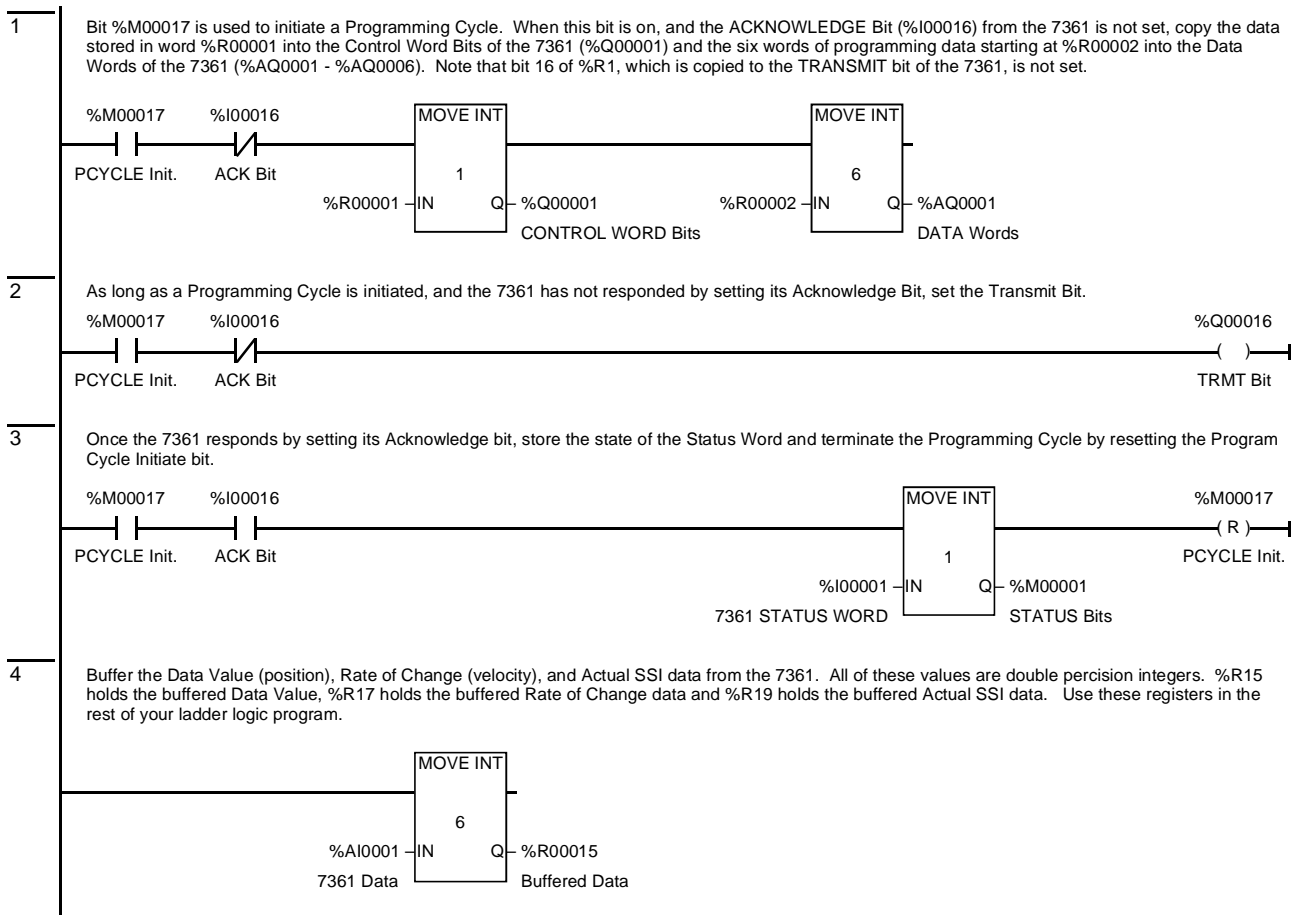

Figure 2.2 Program Cycle Ladder Logic

**STEP 7: Load Programming Data into the 90-30 Registers**

7.1) If you use the programming example above, then the %R1 through %R7 registers must have data in them before you can program the 7361. Refer to the *[%Q and %AQ Output Data Format](#)* section on page 39 for the format of the data to be written to the 7361.

**STEP 8: Verify and Fine Tune Your System**

8.1) Appendix A, *[FREQUENTLY ASKED QUESTIONS](#)*, starting in page 41, is a chapter to help you get through initial startup and tells you about the usual causes to problems you may encounter.

*Notes*

# CHAPTER 3

## SYSTEM CHECKOUT

This chapter is for new users that want to bench test the 7361 to become familiar with its features. Because it assumes you're *bench* testing the module, installation practices such as grounding and surge suppression are not covered. This chapter also assumes that you know how to configure modules and program a 90-30 PLC.

### Needed Equipment

The following equipment is needed to walk through the system checkout:

- The 7361, including the MS-8 Transducer Input connector that shipped with the unit
- A 90-30 baseplate and power supply
- A 90-30 processor module if the processor is not built into the baseplate
- A PC with programming software such as VersaPro
- A communication cable to connect the PC and 90-30 processor.

An SSI transducer is not absolutely needed for the system checkout, but certainly can be used. If you decide to use an SSI transducer, you will need the following additional items:

- The SSI transducer and cable
- An external power supply for the transducer (Typically a 24Vdc supply, but check your transducer's specifications.)
- A pair of wire cutters and strippers
- Enough wire to connect the power supply, 7361, and transducer.

### Install the Modules in the Baseplate

Follow GE-Fanuc's instructions to install the 90-30 power supply in the baseplate. If you're not using the 311 or 313 baseplate that includes the processor, also install your processor module. Install the 7361 in any free slot. It installs in the baseplate like all other 90-30 modules.

### Wire the Transducer Cable (optional)

You don't need a transducer to run this bench test. (The 7361 reports a hexadecimal value of 1FFFFFFh as the SSI data when a transducer is not attached. The bench test is just going to preset this value over the back-plane.) If you want to attach a transducer to the module then this is the time to do it.

You'll need to wire the transducer cable and the transducer's power supply to the 7361's Transducer Input Connector. Of course, it seems that every manufacturer has their own color code so you'll probably have to dig through your transducers spec sheets to wire it correctly. Figure 3.1 shows the color codes for MTS Temposonics III and Balluff BTL-5 linear displacement transducers and gives the pinout of the Transducer Input Connector.

**NOTE** The figure also shows how to wire the transducer's power supply to the 7361. These connections have to be made for every transducer, not just the Temposonics III or BTL-5 transducers.

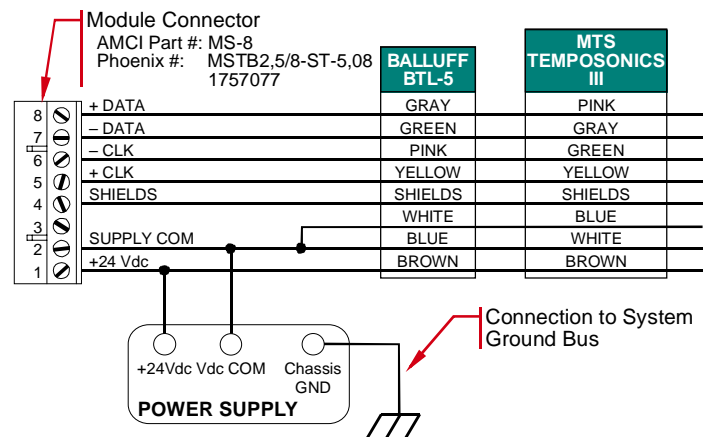

Figure 3.1 Transducer Input Connector Wiring



### Attach the PC to the Processor

Follow GE-Fanuc's literature for connecting the communication cable from the PC to the 90-30 power supply.

### Apply Power

Review all power wiring and apply power to the PLC. The 7361 should power up in a few seconds and the RUN LED should turn on. If it doesn't, remove power and recheck your wiring.

If you're using an SSI transducer, turn on its power supply after the PLC is powered.

#### NOTE

You don't normally have to power up the system in this way. Applying power to both the PLC and transducer at the same time is acceptable. Powering them up separately allows you to determine a power supply related problem.

### Create a New Project

If necessary, create a new project in your programming software for this system checkout and configure your baseplate and processor. Data for configuring the 7361's slot is in the next section. Unfortunately, it's beyond the scope of this manual to give details on how to create a new project and configure the GE-Fanuc hardware. If your GE-Fanuc software is new to you, refer to their literature for assistance.

### Configure the 7361's Slot

Assuming that you're working with a new project and the 7361 is the only module in the baseplate, configure the 7361's slot as follows. If you're incorporating the 7361 into an existing project while working through this chapter, you may have to adjust the reference addresses given below.

- **Module ID:** 3
- **%I Ref Addr:** %I00001
- **%I Size:** 16 bits
- **%Q Ref Addr:** %Q00001
- **%Q Size:** 16 bits
- **%AI Ref Addr:** %AI0001
- **%AI Size:** 6 words
- **%AQ Ref Addr:** %AQ0001
- **%AQ Size:** 6 words
- **%R Registers:** *Not used. Leave at default values.*
- **Bytes 1-16:** *Not used. Set to zero.*

If you are using the VersaPro Software, open the Hardware Configuration screen and right click on the slot where the 7361 module is installed. Select *Add Module* from the menu that appears. Click on the **3rd Party** tab in the Module Catalog and then select 3rd Party Module and click OK. You'll now be at the screen where you can enter the above data.

In the VersaPro software, you also have **Wiring** and **Power Consumption** tabs where you can enter additional information on the module. The *Software Configuration* section of chapter 7, starting on page 35 gives suggested values for these fields.

### Add Ladder Logic

Add the ladder logic on the following page to the project. The instructions assume that the starting addresses of the %I, %Q, %AI, and %AQ memory assigned to the 7361 are all "1". The additional memory used by the program is as follows:

- **%M1-16:** Buffers the %I data from the 7361.
- **%M17:** Setting this bit starts a Programming Cycle.
- **%M18:** "0" sends programming data to 7361, "1" sends *Apply Preset* command to the 7361.
- **%R1-7:** Holds the programming data to be written to the 7361.
- **%R8-14:** Holds the data to preset the 7361's Data Value.
- **%R15-20:** Buffers the %AI data from the 7361.

**Add Ladder Logic (continued)**

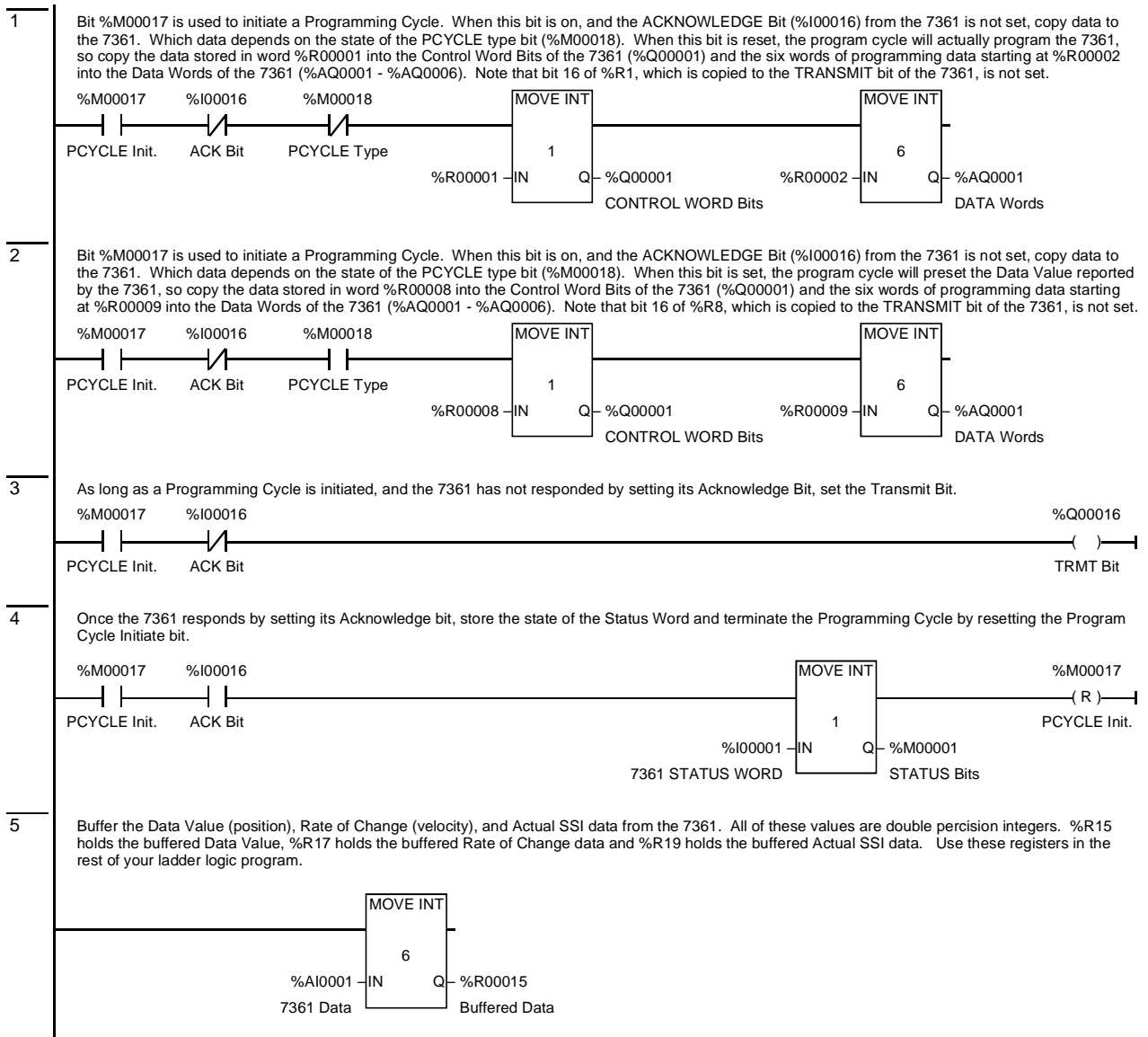

Figure 3.2 System Checkout Ladder Logic

## Set Register Values

### If You Don't Have a Transducer

Assuming that you don't have a transducer attached to the 7361, the following table shows register values that you must enter before running the program. Note that registers %R5-6 and %R12-13 are treated as a double precision integers. We'll only briefly describe the parameters you're programming here. Chapter 4, *SPECIFICATIONS*, starting on page 19 describes the parameters, and chapter 7, *%Q and %AQ Output Data Format* starting on page 39, describes the output register format.

REGISTER	VALUE	REGISTER	VALUE
%R00001	62, (003Eh)	%R00008	1, (0001h)
%R00002	266, (010Ah)	%R00009	0
%R00003	1,000, (03E8h)	%R00010	0
%R00004	1,024, (0400h)	%R00011	0
%R00005	125,420	%R00012	0
%R00006	(0001E9ECh)	%R00013	
%R00007	500, (01F4h)	%R00014	0

Table 3.1 Sample Register Values

First note that the registers are broken down into two groups, %R1-7 and %R8-14. These represent the two programming blocks that you send to the 7361 based on the state of the %M18 bit in the ladder logic.

%R1 is a Control Word, which specifies what data is contained in the rest of the block and what actions to take. The value of %R1 tells the 7361 to program itself with the rest of the data in the block. Note that this value will change based on what you're programming.

%R2 defines the SSI clock frequency along with where the Data Value is embedded in the SSI data and its format. In our example, we'll assume that the Data Value is a 10 bit binary number that starts at the first bit of the SSI stream.

%R3 and %R4 are Scalars, that let you scale that Data Value to engineering units.

%R5-6 is a double precision integer that stores the Preset Value.

%R7 sets the time between Rate of Change (velocity) updates in milliseconds. In our example, the Rate of Change will update every half second.

%R8 is also a Control Word and it tells the 7361 to do one thing, apply the Preset Value. When this command is sent, the 7361 will set the Data Value to 125,420. (Assuming that the %R1-%R7 block is sent first.) Because you're only presetting the position, the module doesn't need any other data, so %R9-14 are set to zero.

### If You Do Have a Transducer

If you're using a transducer for the system checkout then you'll have to determine the value of the %R2 register. This word programs the *SSI Clock Frequency*, *MSB Number*, *Number of SSI Data Bits*, *Data Type*, and *Data Logic* parameters. These parameters are collectively called the *SSI Setup Parameters* and are described in chapter 4 starting on page 21. The format of this register is given in the *%Q and %AQ Output Data Format* section of chapter 7, starting on page 39.

You may also want to change the values in the %R3 and %R4 registers. These two registers are the Scalar Multiplier and Scalar Divisor that scale the Data Value before it is transmitted to the processor. The use of the Scalars is described in the *Scalar Multiplier & Scalar Divisor* section of chapter 4, starting on page 22. If you are using a LDT transducer, figure 4.3, *Scalar Values for Linear Measurement Conversion* on page 22 lists the Scalar Multiplier and Scalar Divisor values for common conversions.

### **Download the Program and Switch to Run Mode**

It's beyond the scope of this manual to tell you how to accomplish this in your software. If you need help downloading the program then refer to your GE-Fanuc documentation.

### **Initiate a Programming Cycle**

Bring up the values of your %M bits and verify that %M18 (PCYCLE Type) equals zero. This will cause the values in %R1-7 to be written down to the 7361.

Set the %M17 bit (PCYCLE Init). Note that it will reset itself within one or two scans because of the  $-(R)-$  instruction in rung 4.

Now check the values of %M1-16. They should all be zero. If they're not, you have an error in your data or ladder logic. The easiest way to clear the error is by cycling power to the rack, making your corrections, and trying again. (There is a *Clear Errors* command that is covered in chapter 7.)

### **Monitor Data Value**

Once the Programming Cycle completes without error, check the value of %R15-16. This is the double precision integer that holds the Data Value. If you are not using a transducer, the Data Value will be 999. If you are using a transducer, the value will be somewhere within its range. You'll be able to see a change in Data Value and Rate of Change (%R17-18) as you adjust your transducer.

### **Preset the Data Value**

Change the value of the %M18 bit (PCYCLE Type) to one. This will cause the values in %R8-14 to be written down to the 7361.

Set the %M17 bit (PCYCLE Init). Note that it will reset itself within one or two scans because of the  $-(R)-$  instruction in rung 4. Once again, the values of %M1-16 should equal zero.

Now look at the Data Value in %R15-16. It should now equal 125,420, which is the double precision Preset Value specified in registers %R5-6.

You can change the Preset Value by changing %R5-6, resetting %M18 and then setting %M17 to initiate a new Programming Cycle. Note that the Data Value doesn't change. In order to actually apply the new Preset Value, set %M18 and then set %M17 to initiate another Programming Cycle. The Data Value will now be preset to the new Preset Value.

This highlights an important item:

**NOTE**  Writing down a new Preset Value does not change the Data Value. The Data Value is only changed when the *Apply Preset* bit (Bit 1 of the %Q bits assigned to the 7361) is set during a Programming Cycle.

Even though we don't do it in this system checkout, you can write down new programming data and apply the Preset Value with one programming cycle.

*Notes*

# CHAPTER 4

## SPECIFICATIONS

### Module Location

Any 90-30 baseplate I/O slot. Requires 16 %I bits, 16 %Q bits, 6 %AI words and 6 %AQ words.

### Compatible Transducers

Any transducer that outputs data in single word SSI format. The 7361 reports all 25 bits. Multi-word transfers are not supported.

### Transducer Input Isolation

Optically Isolated (1500 Vac)

### Programmable Parameters

*SSI Setup Parameters –*

- SSI Clock Frequency
- Number of Data Bits
- MSB Number
- Data Type
- Data Logic

*Data Setup Parameters –*

- Scalar Multiplier
- Scalar Divisor
- Preset Value
- Count Direction
- Rate Update Time

### Data Value (position) Range

$\pm 33,554,431$  counts max. ( $2^{26}$  total counts)

### Data Value (position) Preset

Data Value can be preset to any value within the range of  $\pm 33,554,431$ .

### Rate of Change (velocity) Range

33,554,431 counts per second max.

### Rate of Change (velocity) Resolution

Determined by, and identical to, the Data Value resolution. i.e. If the resolution of the Data Value is 0.001", the resolution of the Rate of Change will be 0.001" per second.

### Rate of Change (velocity) Update Time

Programmable from 1 millisecond to 1,000 milliseconds with 1 millisecond resolution.

### Data Transfer

Data updated automatically during program scan.

Programming the module is accomplished with a *Programming Cycle*, which uses two handshaking bits (Transmit and Acknowledge).

### Data Available to Processor

Data Value, Rate of Change, status bits, and raw SSI data.

### Program Storage

EEPROM. Endurance of 100,000 write cycles.

### baseplate Power Requirements

+5 Vdc @ 0.230A (1.15 Watts)

### Transducer Power Supply

External +24 Vdc supply needed for transducer operation.

### Environmental Conditions

Operating Temperature: 0 to 60° C  
Relative Humidity: 5 to 95%  
(non-condensing)  
Storage Temperature: -40 to 85° C

## Required External Supply

The 7361 requires an external supply to power the SSI transducer. This power supply is typically +24Vdc and its size depends on the current requirements of the transducer. You can use the supply for more than one transducer but before doing so verify that the power supply common will be isolated from the body of each transducer. This check is to make sure the supply common is isolated from earth ground. Local safety codes may require you to ground the power supply common at one point, but if you tie it to earth ground at each transducer, you will most likely create a ground loop problem that will affect reliable operation and may even damage the transducers or modules.

You can also use a system supply for the transducer. (A system supply provides 24Vdc for the entire machine.) If you do this, you must have surge suppression devices on all inductive loads attached to the supply such as relays, motor contactors, solenoids, etc. This lowers the possibility of SSI data corruption by limiting the amount of EMI “noise” generated by these inductive devices.

## Transducer Cabling

Follow the specifications of the transducer manufacturer when determining the transducer cable. Pre-assembled and tested cables are usually offered by the transducer manufacturer. Because SSI signals are low voltage, low power signals, an overall shield or individually shielded pairs is required.

## Compatible Transducers

The 7361 is compatible with any transducer that outputs serial data using the SSI protocol. The module has been tested with Balluff BTL-5 and MTS Temposonics III linear displacement transducers, Stegmann optical encoders, and SICK optical distance sensors. Note that the 7361 does not support multi-word SSI transfers. Even though the SSI definition includes the multi-word transfer, it is rarely used in actual applications.

## SSI Protocol Overview

Figure 4.1 shows how a 7361 module reads data from an SSI transducer. Note that the formal definition considers Bit 25 to be a stop bit, which is always zero. However, AMCI is aware of some companies using Bit 25 as an information bit, either as part of the data or as an error bit. Therefore, AMCI reads and includes this bit value in the SSI data reported to the 90-30 processor.

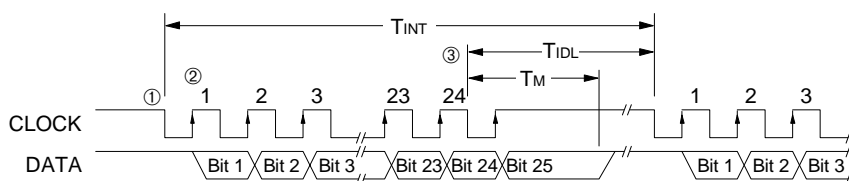

- ① The first falling edge of the clock signal latches the SSI data. Note: Some transducers latch the data at the end of the previous interrogation.
- ② The next 25 rising edges of the clock shift out the 25 data bits.
- ③  $T_{INT}$  is the time between interrogations.  $T_{IDL}$  is the time between the end of the last interrogation and the start of the next.  $T_M$  is the time that Bit 25 is valid, which is typically 12 to 20  $\mu$ S. The transducer must have new data available within the  $T_{IDL}$  time period if the system is to work properly. The table below gives the values of  $T_{INT}$  and  $T_M$  for the two different clock frequencies available with the 7361.

ClockFRQ	$T_{INT}$	$T_{IDL}$
125 KHz	500 $\mu$ S	308 $\mu$ S
500 KHz	250 $\mu$ S	202 $\mu$ S

Figure 4.1 SSI Data Stream Format



Multi-word transfers are accomplished by holding the clock signal low for the  $T_M$  time period and restarting the clock. This signals the transducer to transfer additional bits of data instead of restarting at bit 1. Because multi-word transfers is rarely used in applications, the 7361 does not support this protocol.



**Programmable Parameters**

The 7361 is configured by setting its *Programmable Parameters*. These parameters are broken down into two groups.

- **SSI Setup Parameters** – Five parameters that are used to extract the SSI Data Value from the bit stream. These parameters define the clock speed of the data transfer, the position and length of the SSI data within the bit stream, and the format of the data.
- **Data Setup Parameters** – Five parameters that affect the Data Value and Rate of Change information. These parameters allow you to scale the Data Value, preset it to a programmable count, and set the update time of the Rate of Change information.

**SSI Setup Parameters**

**SSI Clock Frequency**

This parameter allows you to set the SSI clock frequency to one of two values: 125 KHz or 500 KHz.



The default value of 125 KHz will work in all applications, but you may get a more accurate reading in high speed applications if you set the SSI clock to 500 KHz. Consult your transducer documentation to determine its maximum operating frequency. Remember that the maximum SSI clock frequency is also dependent on the length of the transducer cable.

**Number of Data Bits & MSB Number Parameters**

As the examples show in figure 4.2, these two parameters tell the 7361 where the SSI data is embedded in the data stream. The Number of Data Bits parameter specifies the length of the data and the MSB Number parameter specifies the bit that starts the SSI data. The default value of the MSB Number parameter is one. The default value for the Number of Data Bits parameter is twenty-four.

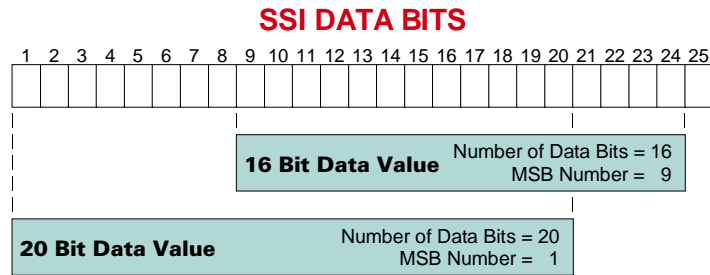

Figure 4.2 Embedded Data Value

Refer to the documentation that came with your transducer to determine where the SSI data is located in the SSI data stream. If you are using a Balluff LDT, the default values should work correctly. If you are using a MTS LDT, Set the Number of Data Bits equal to the LDT’s number of bits and the MSB Number to one.

**Data Type**

This parameter tells the 7361 to interpret the SSI data as a binary number or a gray code number. The default value is *Binary*.

**Data Logic**

This parameter is included to handle situations where the SSI data is reported with negative logic. If this parameter is set, the 7361 will invert the data bits before performing any scaling. The default value is *Positive*. When this parameter is left at its default value, the 7361 will use the SSI data as it is from the transducer.



Appendix B, *COMMON CONFIGURATIONS*, starting on page 43 lists several SSI transducers along with the parameter values that should be used to extract the data value from the bit stream. The appendix also gives hints on how to determine the correct values if you only know the number of bits in the data stream.

## Data Setup Parameters

Once the 7361 has extracted the SSI data from the SSI data stream, it uses the Data Setup Parameters to convert the raw SSI data into the Data Value it reports to the processor. The formula for determining the Data Value is:

$$\text{Data Value} = \text{SSI Data} * (\text{MUL} / \text{DIV}) + \text{LO}$$

where: MUL = Scalar Multiplier

DIV = Scalar Divisor

LO = Linear Offset. The Linear Offset is an internal parameter that normally equals zero. The Linear Offset is changed when you apply the Preset Value to the Data Value.

## Scalar Multiplier & Scalar Divisor

These two parameters are used to scale the SSI data. Both parameters have a default value of one and can range in value from 1 to 32,767. The Scalar Multiplier must be less than or equal to the Scalar Divisor. In other words, the ratio of Multiplier to Divisor cannot be greater than one.

Linear displacement transducers from Balluff and MTS have resolutions measured in  $\mu\text{m}/\text{count}$ . The 7361 can easily convert to the more familiar US customary system of inches. The figure below shows the Multiplier and Divisor values needed to convert from various metric resolutions to US customary resolutions. For example, to convert data from a LDT with  $5\mu\text{m}/\text{count}$  resolution to  $0.0005"/\text{count}$  resolution, use a Multiplier of 50 and a Divisor of 127.

		Desired Resolution				
		0.0002"	0.0005"	0.001"	0.002"	0.005"
LDT Resolution	5 $\mu\text{m}$	$\frac{125}{127}$	$\frac{50}{127}$	$\frac{25}{127}$	$\frac{25}{254}$	$\frac{5}{127}$
	10 $\mu\text{m}$		$\frac{100}{127}$	$\frac{50}{127}$	$\frac{25}{127}$	$\frac{10}{127}$
	20 $\mu\text{m}$			$\frac{100}{127}$	$\frac{50}{127}$	$\frac{20}{127}$
	40 $\mu\text{m}$				$\frac{100}{127}$	$\frac{40}{127}$

 = Desired resolution exceeds resolution of LDT.

Figure 4.3 Scalar Values for Linear Measurement Conversion

Another popular SSI transducer is the DME3000 Laser Distance Sensor for Sick Optic. The resolution of the DME3000 is 0.125 mm per count. Table 4.1 shows the Scalar Multipliers and Divisors needed to convert this to various US customary units.

Desired Resolution	Multiplier	Divisor
0.005"	2000	2,032
0.010"	1000	2,032
0.100"	100	2,032
1.000"	10	2,032

Table 4.1 DME3000 Multiplier/Divisor Pairs

**Data Setup Parameters (continued)****Preset Value**

The Preset Value parameter gives you the ability to offset the Data Value. When you preset the Data Value, the 7361 calculates an internal parameter called the Linear Offset. The Linear Offset is the value needed to make the Data Value equal to the Preset Value. The default Preset Value is zero. Its range is  $\pm 33,554,431$ .

**NOTE** 

- 1) Programming this parameter does not change the Data Value. There is a separate command for presetting the Data Value to the Preset Value.
- 2) The 7361 will issue a Preset Value Error message if you attempt to program a Preset Value that is outside its range of  $\pm 33,554,431$ .
- 3) When the Data Value is preset, the 7361 calculates a Linear Offset that it then applies to the Data Value. The only way to erase the linear offset is to program the *SSI Setup Parameters*.
- 4) Presetting the Data Value generates a linear offset. If you are using a rotary encoder and wish to preset the position, see Appendix C, **WORKING WITH ROTARY ENCODERS**, starting on page 47.

**Count Direction**

This parameter is useful if your Data Value represents a linear position. It gives you the ability to reverse the direction of motion needed to increase the position count. For simplicity's sake, the two values for this parameter are called *Positive Direction* and *Negative Direction*. When this parameter is set to its default of *Positive*, the Data Value is not changed. When this parameter is set to *Negative*, the Data Value is changed to  $(2^n - (\text{Data Value}))$ , where 'n' is the number programmed into the *Number of Data Bits* parameter.

For linear transducers, this has the effect of reversing the direction of motion needed to increase the count. When using LDT's and the Count Direction is set to *Positive*, the Data Value usually increases as the magnet moves away from the head of the LDT. When the Count Direction is set to *Negative*, the Data Value increases as the magnet moves towards the head of the LDT.

If your Data Value represents a rotary position, you can change the count direction with this parameter only if the number of counts in your Data Value is a power of 2. If it is not, you can easily reverse the count direction in your ladder logic.

- 1) Subtract the Data Value from the number of encoder counts and store this value in a temporary register.
- 2) If the Data Value equals zero, then move zero into your temporary register.

Ladder logic that accomplishes this is given in Appendix C, **WORKING WITH ROTARY ENCODERS**, starting on page 47.

**NOTE** 

You will need to preset the Data Value after you program the Count Direction parameter.

**Rate Update Time**

The Rate Update Time sets the amount of time between Rate of Change information updates to the processor. Its range of values is 1 to 1,000 milliseconds, with a default of 100 milliseconds. Decrease this parameter for faster response to changes in the Data Value or increase this parameter for better averaging.

The Rate of Change is always reported in *counts per second*, not *counts per update*. For example, if your Data Value changes by 50 counts in 200 milliseconds and you set your update time to 200 milliseconds, the 7361 reports a Rate of Change value of:  $50 * (1,000/200) = 250 \text{ counts per second}$ .

Therefore, if you set your update time to 1 millisecond, your Rate of Change will always be a multiple of 1,000. If your update time is 10 milliseconds, your Rate of Changes will always be a multiple of 100, and if your update time is 100 milliseconds, your Rate of Changes will always be a multiple of 10.

## Backplane Programming

A 7361 is programmed over the backplane through the input and output registers assigned to it. Because these words are constantly updated, the unit implements a simple hand-shaking protocol to control when it accepts new programming data. This hand-shaking protocol is called a *Programming Cycle*.

### Programming Cycle

A Programming Cycle consists of six steps and is controlled by the *Transmit Bit* in the output data words and the *Acknowledge Bit* in the input data words.

- 1) Write the new programming data into the %I and %AI registers assigned to the module with the Transmit Bit reset. This step insures that the correct data is in the registers before the Programming Cycle begins.
- 2) Set the Transmit bit. A Programming Cycle is initiated when this bit makes a 0→1 transition.
- 3) Once the 7361 is done with the programming data, it will set any necessary error bits and the Acknowledge Bit in its %I register.
- 4) Once you see the Acknowledge Bit set, check for any errors. The error bits are guaranteed valid while the Acknowledge Bit is set.
- 5) Respond to any errors and reset the Transmit Bit.
- 6) The 7361 responds by resetting the Acknowledge Bit. The Programming Cycle is complete.

## EEPROM Parameter Memory

Parameter values are stored in a non-volatile EEPROM memory. This memory type can store parameter values in the absence of power for over fifty years, but you can only write to it a limited number of times before it will be damaged. The EEPROM that AMCI uses is guaranteed for a minimum of 100,000 write cycles.

**NOTE** 

Every time you preset the Data Value, the 7361 calculates an offset and stores this value in the EEPROM. If your application requires you to continuously preset the Data Value, consider doing this in the PLC instead of the 7361.

# GENERAL INSTALLATION GUIDELINES

This chapter gives general information on installing electronic controls in an industrial environment including the importance of proper wiring, grounding, and surge suppression. If you are responsible for installing the 7361, make sure you are familiar with these practices and follow them when installing the system.

### **WARNING**

This chapter is presented as a tool in the hopes of avoiding common installation problems. It is not a substitute for the safety practices called out in local electrical codes or, in the United States, the National Electrical Code published by the National Fire Protection Association. If *any* conflicts exist, local and national codes must be followed. *It is the responsibility of the user* to determine what installation practices must be followed to conform to all local and national codes.

### **Background**

AMCI has extensively tested the 7361, both in the lab and in the field, under a wide range of conditions to see how the unit reacts to an adverse environment. This includes testing the unit after intentionally installing it incorrectly. The results of our testing is the following list of areas that must be addressed when engineering your system. The order of the list shows the areas that have the largest impact on system operation first.

- 1) Surge Suppression
- 2) Grounding
- 3) Wiring
- 4) Power Supply Wattage and Filtering

This list also shows the first areas that should be investigated if your installation experiences problems.

### **Surge (EMI) Suppression**

#### **NOTE**

All inductive devices in the system, such as motors, motor starters, contactors, relays and solenoids, must have surge suppression devices installed across their coils.

This includes all devices that share a power supply with the 7361's transducer, have wiring in the module's enclosure, or wiring that is run in the same conduit as wiring connected to the unit. DC loads are typically suppressed with a flyback diode, while AC loads are typically suppressed with a RC network or varistor.

- **RC Networks are the preferred suppressor for AC loads**

### Surge (EMI) Suppression (continued)

The figure below show where surge suppression devices should be placed in the circuit.

#### Acceptable Connection

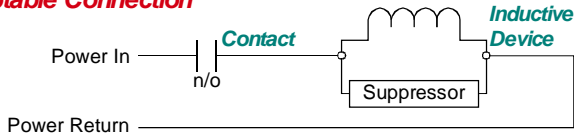

The acceptable connection suppresses noise at its source. The wiring that connects the load to the power supply and contacts will not radiate noise when the load is switched and noise will not be coupled into the power supply.

#### Un-Acceptable Connection 1

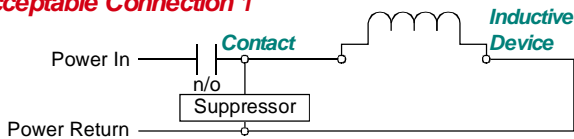

This connection protects the power supply and contact, but allows noise to radiate through the load's wiring where it can be coupled into other cables around it, including the 7361 transducer cable.

#### Un-Acceptable Connection 2

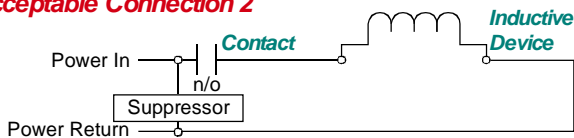

This connection protects the power supply but nothing else. Noise can radiate through the load's wiring where it can be coupled into other cables around it and the contact may eventually be damaged by high voltage inductive spikes.

#### Un-Acceptable Connection 3

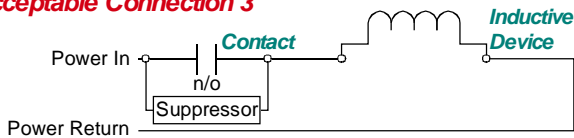

This connection protects the contact but nothing else. Noise can radiate through the load's wiring where it can be coupled into other cables or into the power supply. Noise in the supply may affect any device powered by it, including the 7361 or its SSI transducer. Also, if the suppressor shorts out, the load will always receive power.

Figure 5.1 Installing Surge Suppression Devices

### Surge Suppression: DC Outputs

All inductive DC loads require a commutating, or “fly-back” diode across the load. Inductive DC loads include relays, solenoids, and DC motors.

Unlike resistors, diodes have a polarity and only conduct current in one direction. Therefore, care must be taken when installing diodes. As shown in the figure below, the *cathode* of the diode, which is denoted by the white or black band on one end of the diode, must be installed on the positive side of the load. If you install the diode backwards, it will most likely destroy itself as soon as you apply power to the load.

#### DC Load Connection

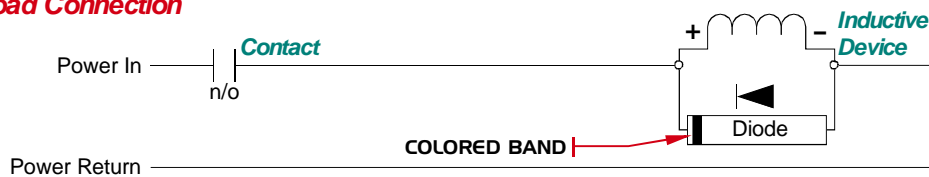

Figure 5.2 DC Output Surge Suppression

- The diode must be sized to handle the inductive surge of the load when it turns off.
- Some devices can be ordered with built in fly-back diodes, or the device manufacturer will offer suppressors designed specifically for the device. These types of devices are strongly recommended.

***I/O Wiring (continued)***

**Surge Suppression: AC Outputs**

If you are switching AC loads with hard contacts such as mechanical relays or contactors, then you must install a suppression network on the load switched by the relay. The two most common suppressors for AC loads are varistors and R-C networks.

➤ **AMCI strongly suggests R-C networks for all AC applications.**

A varistor is a solid state device that turns on and conducts when the voltage across its terminals exceeds its rated value. Herein lies the problem with using a varistor as an AC suppressor. The voltage (problem) must be generated before the varistor responds. In our testing we have found that hard contacts will still arc when a varistor is placed across the AC load. This arcing is due to the fact that the breakdown voltage of the air between the contacts when they first open can be less than the rated voltage of the varistor. If the instantaneous AC voltage applied to the contacts is above the breakdown voltage of air, but less than the rated voltage of the varistor, the contacts will arc.

On the other hand, an R-C network acts as a low-pass filter, instantaneously dampening fast transients when they occur. The main drawback of R-C networks is that they are harder to correctly specify than varistors. Varistors only require you to specify breakdown voltage and power dissipation ratings. R-C networks require you to balance the need of suppression when the contacts open against the amount of surge current the relay can tolerate when the contacts close. Table 5.1 shows the trade-offs you must be aware of when specifying R-C networks.

	<b>When Contacts Close</b>	<b>When Contacts Open</b>
Low Resistance, High Capacitance	Higher surge current through relay contacts to charge capacitor. (Negative)	Lower transient voltage spike. (Positive)
High Resistance, Low Capacitance	Lower surge current through relay contacts to charge capacitor. (Positive)	Higher transient voltage spike. (Negative)

Table 5.1 R-C Network Trade-offs

In general, capacitor values range from 0.1 to 1.0  $\mu$ F and resistor values range from 150 to 680 ohms.

The easiest way to specify a R-C network is by following the recommendations of the load’s manufacturer. Most manufacturers have tested and specify standard R-C networks, and many sell networks that are designed to integrate with their products. If you cannot get help from your load’s manufacturer, feel free to contact AMCI for assistance.



### Grounding

Proper grounding is the single most important consideration for a safe installation. Proper grounding also ensures that unwanted electrical currents, such as those induced by electromagnetic noise, will be quickly shunted to ground instead of flowing throughout the machine.

AMCI strongly suggests the use of a ground bus in the enclosure that houses the 7361. As shown in figure 5.3, the ground bus becomes the central grounding point for the enclosure and its equipment. Bonding wires are run from the enclosure and each piece of equipment to the ground bus, and then a single grounding electrode conductor is run directly to the system's grounding electrode.

Each connection must be separate, so a ground bus is typically fabricated in-house or by the panel shop responsible for wiring the enclosure.

- All ground connections must be permanent and continuous to provide a low-impedance path to earth ground for induced noise currents.
- The chassis of the baseplate must be connected to chassis ground through its mounting in the enclosure, and with a grounding wire connected to the CHASSIS pin of the 90-30 power supply.
- Any non-isolated power supply attached to the 7361 must be connected to the same chassis ground as the unit to avoid ground loops.
- The digital ground of the SSI transducer must be isolated from chassis ground at the transducer in order to avoid ground loops.
- All isolation transformer secondary windings that are grounded to conform to local or national codes must be grounded to the same earth ground as the machine ground.

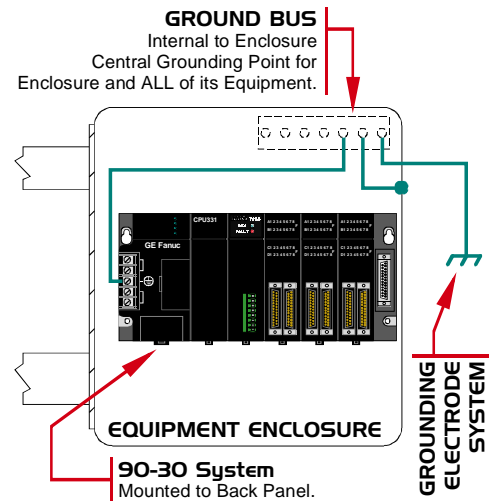

Figure 5.3 Ground Bus System

### Wiring

The most important aspect of wiring is determining the amount of voltage and power carried by the cable and separating low power cabling from high power cabling. Inside of an enclosure, separate the two types of cabling with as much physical distance as possible and keep the wiring neat. Outside of the enclosure, low and high power cabling must be run in separate conduits.

#### ➤ Transducer Cabling (Low Power)

- 1) Transducer signals are of low voltage and low power. Transducer cable can be installed in conduit along with other low power cabling such as communication cables and low power ac/dc I/O lines. It cannot be installed in conduit with ac power lines or high power ac/dc I/O lines.
- 2) The shield of the cable must be grounded at the unit only. If you must splice the transducer cable, it must be done in a grounded junction box. When splicing, treat the shield as a signal-carrying conductor. Do not connect the shield to earth ground at the junction box or transducer. If your transducer cable has individually shielded pairs, then ideally, the shields in the cable are also kept isolated from each other in the junction box as well.

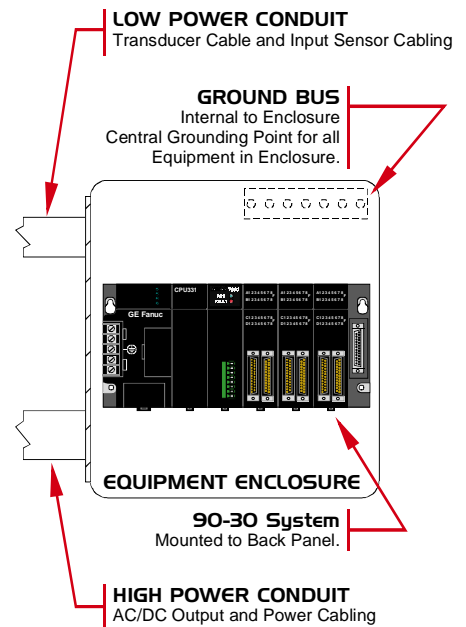

Figure 5.4 Typical Enclosure

## **Wiring (continued)**

### ➤ **Input Cabling (Low Power DC & AC)**

- 1) Cabling from low power DC sensors, typically tied to PLC input cards, must be shielded. Follow the two guidelines given above for Transducer Cabling. DC Input cabling and the transducer cable can be installed in the same conduit.
- 2) Depending on local codes, cabling from low power AC sensors may or may not be installed with cabling from DC sensors. Follow the two guidelines given above for Transducer Cabling. Cabling for AC sensors, must, without exception, be shielded.

### ➤ **Output Wiring (High Power AC & DC)**

- 1) Output Wiring must be kept separate from the transducer and input wiring in order to lessen the possibility of coupling transient noise into the low power cabling.
- 2) If a conduit containing the transducer cable or input wiring must cross conduit that contains Output Wiring, they must cross at right angles.

### ➤ **Power Supply Wiring (24Vdc)**

- 1) If you have a separate DC supply for the SSI transducer, then it is most likely a small one that is mounted in the enclosure with the 90-30 system. In this case, AC power for the supply can be routed with output wiring. AC power should never be routed with the transducer or input cabling.
- 2) If you are using a system supply to power the SSI Transducer and the power supply is outside of the enclosure, then the supply lines should be run with the output lines if local codes permit.

### ➤ **Other Power Wiring (High Power AC & DC)**

- 1) Power Wiring must be kept separate from the transducer and input wiring in order to lessen the possibility of coupling transient noise into the low power cabling.
- 2) If a conduit containing the transducer cable or input wiring must cross conduit that contains Power Wiring, they must cross at right angles.
- 3) Whenever possible, conduit that contains transducer or input cabling must be kept 1 foot (30 cm) away from 120Vac conductors, 2 feet (61 cm) from 240Vac conductors, and 3 feet (91 cm) from 480+ Vac conductors.

## **Power Supply Wattage and Filtering**

A properly sized power supply is vital to system operation. The best guideline that we can give you is to buy the best supply your budget allows.

When sizing system supplies, take into consideration the surge requirements of the components you are attaching to the supply. Most devices draw a “surge” current for a brief time when they power up. If your supply cannot accommodate these surge currents, the output voltage may momentarily drop when a device turns on, causing data errors in the SSI transducer or 7361.

The other thing to consider when choosing a supply is output filtering. The better the supply’s filtering, the better it can absorb noise that may be induced into the power supply wiring.

*Notes*

## INSTALLING THE 7361

This chapter only covers installing the 7361, the SSI transducer and the transducer power supply. It assumes you already have the rest of your 90-30 system installed in your enclosure and you have followed sound installation practices. This includes proper grounding, cable installation and surge suppression. If you're new to installing electronic control systems, refer to GE-Fanuc hardware installation manuals and chapter 5 of this manual, **GENERAL INSTALLATION GUIDELINES**, starting on page 25.

### **Inserting the 7361 into the Baseplate**



**NOTE** As part of our licensing agreement with GE-Fanuc, AMCI purchases the module case directly from GE-Fanuc to insure 100% compatibility with their baseplate. (We also purchase their backplane interface IC under license to insure 100% electrical compatibility with the system.) Because of this, the 7361 installs in the baseplate like every other 90-30 I/O module.



**REMOVE POWER FROM THE BASEPLATE BEFORE INSTALLING OR REMOVING ANY 90-30 I/O MODULE.** Installing or removing any module while power is applied may damage the module or baseplate and/or cause unexpected operation with possible injury to personnel.

### **To Insert the 7361**

- 1) Grasp the module firmly with the front of the module facing you.
- 2) Tilt the module upwards and insert the case's top hook into the top notch of the slot.
- 3) Rotate the 7361 into the baseplate until the locking lever snaps into the bottom notch of the slot. It doesn't require a great deal of force to engage the backplane connectors, so do not force the module into the baseplate. Doing so may damage the backplane connectors.
- 4) Visually inspect the module to be sure it is properly seated.

### **To Remove the 7361**



**CAUTION** Even when you remove power from the 90-30 system, you may still have power from the transducer supply. Remember to remove power from this supply before removing the 7361's Transducer Input Connector.

- 1) Remove the Transducer Input Connector.
- 2) Locate the locking lever on the bottom of the 7361 and firmly press in up. This pivots the locking hook out of the slot's bottom notch.
- 3) Rotate the bottom of the module out from the baseplate and disengage the hook at the top of the 7361 from the slot's top notch.

### **Transducer Mounting**

In general, follow the mounting guidelines supplied by the SSI transducer's manufacturer as well as local and national safety codes.

The one thing that you must check is whether or not the power supply common input is tied to the case of the transducer. Normally it is not, and this allows you to bond your transducer's power supply to earth ground at the same point that your 90-30 is bonded. If it's not isolated, then you will have to determine the best place to ground the supply in order to make your installation safe, but still avoid ground loops.

## Transducer Power Supply

You will be using one of two choices for a transducer power supply in your application. The first choice is using a large system supply that powers other devices on your machine. The other choice is a small dedicated supply that only powers the SSI transducer.

- **AMCI strongly urges you to use a dedicated supply whenever your budget and panel space allow it.**

### When Using a System Supply

If you are using a system supply, then you must be aware of the following problem areas.

- 1) **GROUNDING.** Grounding is a concern if your system supply if it isn't bonded to your machine's grounding electrode through the same grounding electrode conductor as you 90-30 system, or the SSI Transducer internally connects the DC common to its case. Figure 6.1 shows these two potential problems.

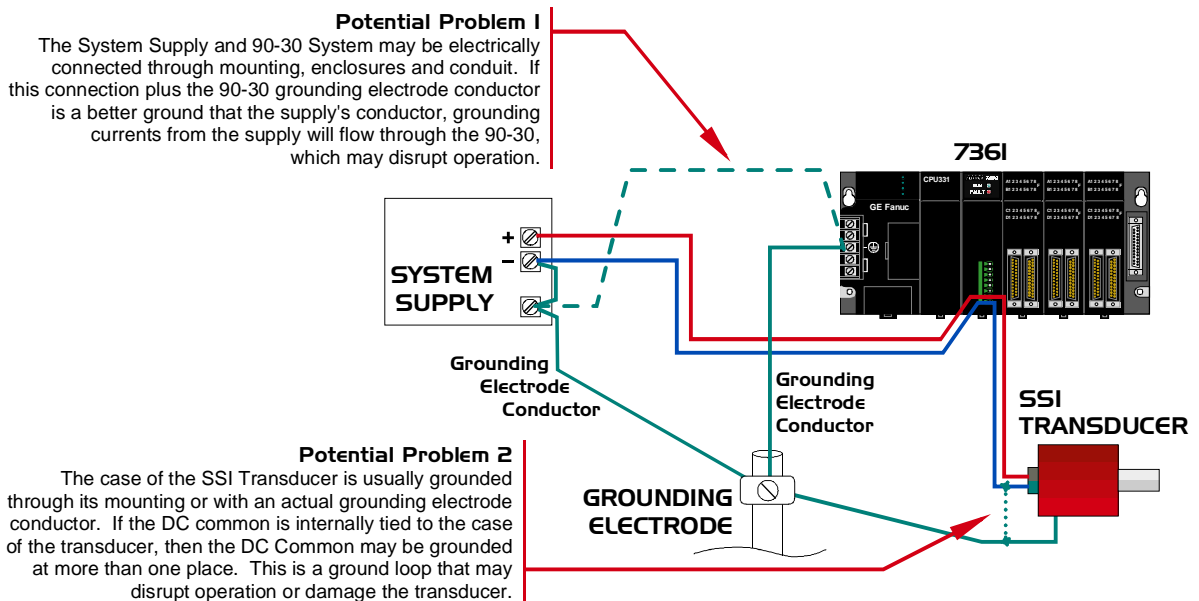

Figure 6.1 System Supply Grounding Problems

- 2) **SURGE SUPPRESSION.** If your system supply is used to switch inductive loads through hard contacts, such as switching solenoids with mechanical relays, then you must install surge suppressors on all of these loads. When an inductive load is switched, it can generate a voltage spike of several hundred volts that is forced onto the power supply lines if it is not suppressed. These spikes may cause random data errors and repeated exposure to these spikes may damage the 7361 or the SSI transducer. For additional information on surge suppressors, refer to the [Surge \(EMI\) Suppression](#) section of chapter 5, starting on page 25.

### When Using a Separate Supply

When using a separate supply for the SSI transducer, mount it in the same enclosure as the 90-30 baseplate.

- If you use the supply to power other devices in the 90-30 system, such as DC output loads, you may need to install surge suppression devices. (See note 2 above.)
- If your SSI transducer doesn't connect the power supply DC common to its case, bond the supply to the ground bus used by the 90-30.
- If your SSI transducer connects the power supply DC common to its case, then you will have to determine the best way to ground the power supply.

**Installing the Transducer Cable**

Follow the transducer manufacturer’s suggestions when specifying the transducer cable or purchase one of the pre-assembled and tested cables usually offered by each manufacturer. When installing the transducer cable, follow these general guidelines.

- SSI signals are low voltage, low power signals. SSI cables must be shielded can be installed in conduit along with other low power cabling such as communication cables and low power ac/dc I/O lines. They *cannot* be installed in conduit with ac power lines or high power ac/dc I/O lines.
- *The shields of the transducer cable must be grounded at one point only!* When installing the cable, treat the shield as a signal carrying conductor and do not connect the shield to ground at any junction box.
  - 1) If you are making your own transducer cable, ground the shields at the 7361 by connecting them to the Shields pin (#4) of the 7361’s Transducer Input Connector. Do not connect the shields to the body of the transducer.
  - 2) If you are using a pre-made cable, or the SSI transducer has an integral cable, verify that the shields are electrically isolated from the body of the transducer. If they are connected, then properly ground the body of the transducer and *DO NOT* connect the shields to Shields pin (#4) of the 7361’s Transducer Input Connector.



The preferred grounding connection for the transducers’ shields is at the 7361. Use this point unless the shields are connected to the body of the transducer through a pre-made or integral cable. Following this practice will eliminate ground loops that could damage the transducer or module.

Figure 6.2 in the pinout of the 7361’s Transducer Input Connector. The diagram also shows which pins to connect the external transducer power supply and the color codes for the cables specified by MTS and Balluff. If you are using an SSI transducer from a different manufacturer, consult their documentation to determine their cable color codes.



The external supply must be connected to both the transducer and the 7361. This is accomplished by running the power supply wires and the transducer wires into the 7361 connector.

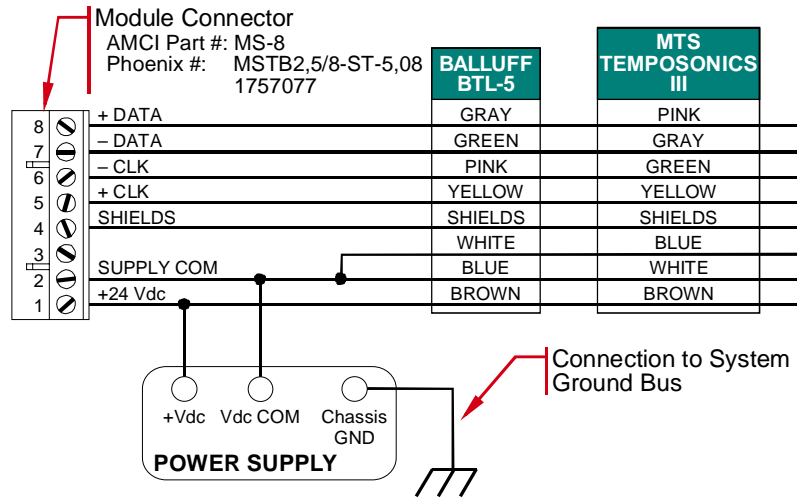

Figure 6.2 7361 Transducer Input Connector

***Notes***

## BACKPLANE PROGRAMMING

A 7361 communicates with the 90-30 processor through the input and output registers assigned to the slot. The input registers are used to transmit status, Data Value, Rate of Change, and SSI data to the processor. The output registers are used to setup the module and preset the Data Value. This chapter details the format of the data and how to program the 7361.

### Software Configuration

Before you can communicate with the 7361, you must configure the slot it resides in.

#### VersaPro Configuration

If you are using the VersaPro software, this is accomplished in *Hardware Configuration*.

- 1) Open Hardware Configuration by clicking on the VIEW menu and selecting Hardware Configuration, or pressing ALT+4.
- 2) Right click on the slot where the 7361 is installed and select "Add Module..." from the menu that appears.
- 3) Click on the 3rd Party tab in the Module Catalog that appears.
- 4) Select "3rd Party" and then click on OK. A window similar to figure 7.1 will appear.

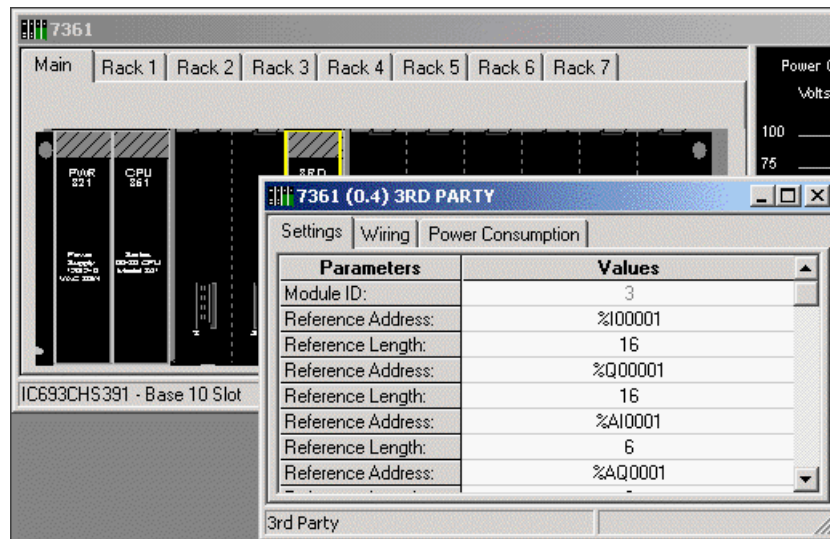

Figure 7.1 VersaPro Configuration Screen

- 5) To configure the slot, enter the reference addresses and lengths. The addresses you use depends on your application. When you choose them, make sure there's no overlap with addresses used elsewhere in your program. The lengths that you use are given in the table below.

Reference Address	Reference Length	Comment
%I	16	Reserves 16 bits. Starting address in the reference address you entered.
%Q	16	Reserves 16 bits. Starting address in the reference address you entered.
%AI	6	Reserves 6 Words. Starting address in the reference address you entered.
%AQ	6	Reserves 6 Words. Starting address in the reference address you entered.

Table 7.1 7361 Memory Requirements





Software Configuration (continued)

VersaPro Configuration (continued)

- NOTE**  1) The %R registers are not used and must be left at their default values.  
 2) Bytes 1 - 16 are not used and must be left at their defaults of zero.

There are two other tabs available on the module configuration screen, *Wiring* and *Power Consumption*. Entering data in these screens is optional, but highly recommended. The following suggestion for the Wiring data is based on tech support calls we've received on similar products. You should also include the wiring colors for your transducer cable. Wiring colors for MTS and Balluff transducers is given in *Installing the Transducer Cable* on page 33.

Terminal	Suggested Text
1	+Vdc IN - Pin 1 is at the bottom!
2	Power Supply Common
3	No Connection
4	Shields
5	+ Clock
6	- Clock
7	- Data
8	+ Data - Pin 8 is at the top!

Table 7.2 VersaPro Wiring Data

The Power Consumption screen lists three values, all of them in watts. For the 7361, enter "1.15" for the +5Vdc (Watts) value and leave the others at zero. (The 7361 only draws backplane power from the +5Vdc supply.) Setting this value allows the software to reflect total power draw from your selected 90-30 power supply.

Logicmaster 90 Configuration

- 1) Enter the Logicmaster 90 Configuration Package
- 2) Press F1 to open I/O Configuration.
- 3) Move the cursor to the slot the 7361 resides in.
- 4) Press F8 to display other module types and then press F3 to select 'frgn' (foreign).
- 5) To configure the slot, enter the data given in table 7.1, *7361 Memory Requirements* on the previous page. The addresses you use depends on your application. When you choose them, make sure there's no overlap with addresses used elsewhere in your program. Also note that the %R registers and Bytes 1 - 16 are not used and must be left at their default values.



## **Programming Cycle**

A Programming Cycle consists of six steps and is controlled by the *Transmit Bit* in the output data words and the *Acknowledge Bit* in the input data words.

- 1) Write the new programming data into the %I and %AI registers assigned to the module with the Transmit Bit reset. This step insures that the correct data is in the registers before the Programming Cycle begins.
- 2) Set the Transmit bit. A Programming Cycle is initiated when this bit makes a 0→1 transition.
- 3) Once the 7361 is done with the programming data, it will set any necessary error bits and the Acknowledge Bit in its %I register.
- 4) Once you see the Acknowledge Bit set, check for any errors. The error bits are guaranteed valid while the Acknowledge Bit is set.
- 5) Respond to any errors and reset the Transmit Bit.
- 6) The 7361 responds by resetting the Acknowledge Bit. The Programming Cycle is complete.

## **Order of Programming Commands**

The 7361 checks and programs the data in the order shown below.

- 1) Clear EEPROM Error
- 2) Number of Data Bits Parameter
- 3) MSB Number Parameter
- 4) Scalar Multiplier Parameter
- 5) Scalar Divisor Parameter
- 6) Preset Value Parameter
- 7) Rate Update Time Parameter
- 8) Apply the Preset Value to change the Data Value

The SSI Clock Frequency, Data Logic, Data Type, and Count Direction parameters are bit values that cannot be check for errors. Both states of each bit are valid.

If the 7361 encounters an error, it will set the appropriate error flag in the %I bits and stop processing the data. All of the data must be correct before the 7361 accepts any changes.



## %I and %AI Input Data Format

Figure 7.2 shows the format of the data transmitted from the 7361 to the processor. The %I bits contain error flags and the Acknowledge Bit. The %AI words contain the Data Value, Rate of Change, and raw SSI data.

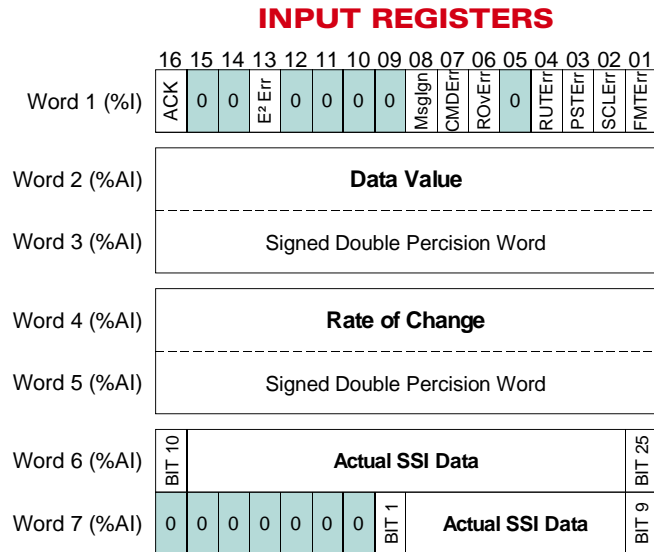

Figure 7.2 Input Data Format

### %I Status Bits

**FMTErr: Format Error, Bit 01.** Set when there is an error with either the MSB Number or Number of Data Bits parameters. The MSB Number has a range of 1 to 24. The Number of Data Bits parameter has a range of 2 to 25. The sum of the two parameters cannot exceed 26.

**SCLErr: Scalar Error, Bit 02.** Set when you attempt to program the Scalar Multiplier or Scalar Divisor parameters to a value outside of their range of 1 to 32,767. It is also set when the Scalar Multiplier is greater than the Scalar Divisor.

**PSTErr: Preset Error, Bit 03.** Set if the Preset Value is set to a value its range of ±33,554,432.

**RUTErr: Rate Update Time Error: Bit 04.** Set if you attempt to program the Rate Update Time parameter to a value outside of its range of 1 to 1,000 milliseconds.

**ROvErr: Rate Overflow Error: Bit 06.** Set if the Rate of Change information exceeds 64,108,863 counts per second.

**CMDErr: Command Error: Bit 07.** Set under four conditions:

- 1) Your ladder logic attempts to program the module while the 7361 has a EEPROM error.
- 2) No Command Bits, %I bits 07-01, where set when the Program Cycle was initiated.
- 3) One or more of the bits specified as zero in the %Q bits, or %AQ word 1, are set to one.
- 4) The Count Direction bit (%Q7) is set without setting the Program Count Direction bit (%Q6).

The Command Error bit is reset when valid instructions are sent to the 7361.

**MsgIgn: Message Ignored: Bit 08.** If an error bit is set, the error must be cleared by re-programming the incorrect parameter. This bit is set if you attempt to program a different parameter without correcting the current error.

**E<sup>2</sup>Err: EEPROM Error: Bit 13.** This bit is set if the value of one or more parameters is corrupted in the EEPROM memory.

**ACK: Acknowledge Bit, Bit 16.** Set by the 7361 to acknowledge programming data from the processor. Error flags in %I bits are guaranteed valid while this bit is set. The 7361 resets this bit after the processor resets the Transmit Bit.



## %Q and %AQ Output Data Format

Figure 7.3 shows the format of the data transmitted from the processor to the 7361. The %Q bits contain command bits and the Transmit Bit that is used to start a Programming Cycle. The %AQ words contain the new parameter values.

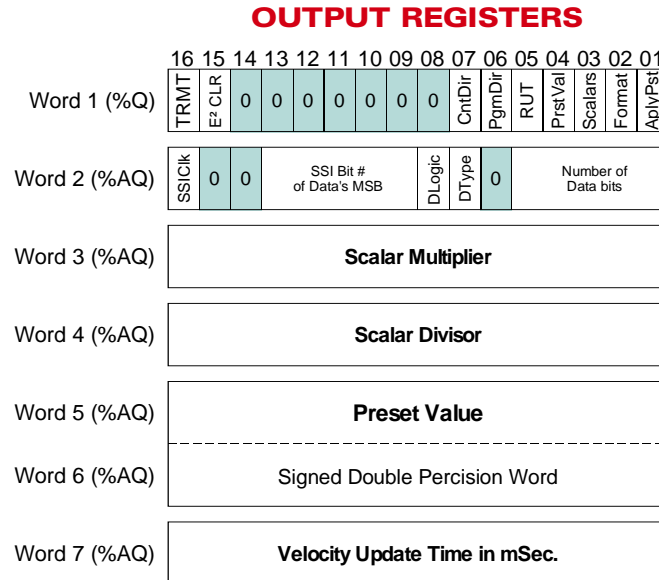

Figure 7.3 Output Data Format

### %Q Command Bits

- ApplyPst: Preset Data Value, Bit 01.** Set this bit to preset the Data Value to the programmed Preset Value. Note that you can program the Preset Value and preset the Data Value to it in a single Programming Cycle.
- Format: Program Format Word, Bit 02.** Set this bit to program the SSI Clock Frequency, MSB Number, Number of Data Bits, Data Logic and Data Type parameters. The new values for all of these parameters are stored in the first %AQ word.
- Scalars: Program Scalars, Bit 03.** Set this bit to program the Scalar Multiplier and Scalar Divisor parameters. The new value of the Scalar Multiplier is stored in the second %AQ word and the Scalar Divisor is stored in the third. The range of both values is 1 to 32,767 and the Scalar Multiplier must be less than or equal to the Scalar Divisor.
- PrstVal: Program Preset Value, Bit 04.** Set this bit to program the Preset Value to the value specified by the double precision integer stored in the fifth and six %AQ words. Note that programming the Preset Value has no effect on the Data Value. To preset the Data Value, you must set the ApplyPst bit, which is the first %Q bit.
- RUT: Program Rate Update Time, Bit 05.** Set this bit to program the Rate Update Time to the value specified in the seventh %AQ word. The valid range of the Rate of Change Update Time is 1 to 1,000 milliseconds.
- PgmDir: Program Count Direction, Bit 06.** Set this bit to program the Count Direction parameter. The parameter value is stored in the Count Direction bit, (CntDir), which is the seventh %Q bit.
- CntDir: Count Direction Value, Bit 07.** When the Program Count Direction (PgmDir) bit is set, the 7361 programs the Count Direction based on this bit. When set to zero, the Count Direction is set to its default value of *Positive*. When this bit is set to one, the Count Direction is set to *Negative*. This bit must be reset if the PgmDir bit is reset. Setting this bit without setting the PgmDir bit will force a *Command Error*.



## **%Q and %AQ Output Data (continued)**

### **%Q Command Bits (continued)**

**E<sup>2</sup>CLR: Clear E<sup>2</sup>PROM Error, Bit 15.** If there is a EEPROM error, setting this bit will clear the error and reset all of the parameters to their default values. Setting this bit when an EEPROM error does not exist will have no effect.

**TRMT: Transmit Bit, Bit 16.** A 0 → 1 transition on this bit initiates a Programming Cycle.

### **%AQ Word 1**

**Number of Data Bits, Bits 05 - 01.** These five bits store the Number of Data Bits parameter. Its valid range is 2 to 25. Note that the 7361 will generate a 'Format Error' if the sum of the Number of Data Bits and MSB Number parameters exceeds 26.

**DType: Data Type Value, Bit 07.** This bit stores the value of the Data Type parameter. When set to zero, the Data Type parameter is set to its default of *Binary* data type. When this bit is set to one, the Data Type parameter is set to *Gray Code* data type.

**DLogic: Data Logic Value, Bit 08.** This bit stores the value of the Data Logic parameter. When set to zero, the Data Logic parameter is set to its default of *Positive*. When this bit is set to one, the Data Logic parameter is set to *Negative*.

**MSB Number, Bits 13 - 09.** These five bits store the value of the MSB Number parameter. Its valid range is 1 to 24. Note that the 7361 will generate a 'Format Error' if the sum of the Number of Data Bits and MSB Number parameters exceeds 26.

**SSIClk: SSI Clock Frequency, Bit 16.** This bit stores the value of the SSI Clock Frequency parameter. When set to zero, the SSI Clock Frequency parameter is set to its default of 125 KHz. When this bit is set to one, the SSI Clock Frequency parameter is set to 500 KHz.

## **Parameter Ranges and Factory Defaults**

Parameter	Range	Default
Count Direction	Positive / Negative	Positive
Rate Update Time	1 to 1,000 milliseconds	100 milliseconds
Data Logic	Positive / Negative	Positive
Data Type	Binary / Gray Code	Binary
SSI Clock Frequency	125 KHz or 500 KHz	125 KHz
MSB Number	1 to 24 inclusive	1
Number of Data Bits	2 to (26 – MSB Number) inclusive	24
Scalar Divisor	1 to 32,767 inclusive	1
Scalar Multiplier	1 to (Scalar Divisor – 1)	1
Preset Value	± 33,554,432 inclusive ±(2 <sup>26</sup> –1)	0

## FREQUENTLY ASKED QUESTIONS

This chapter contains answers to the most common tech support questions received on the 7361 and similar products.

### **Why does my raw SSI data equal 33,554,431 and doesn't change?**

The raw SSI data from the 7361 is placed in the fifth and sixth %AQ words assigned to the module. If this double precision value is 33,554,431, (1FFFFFFh), then your SSI data is coming into the module as all 1's. Even though it may be possible for your sensor to output all 1's as valid data, this condition usually indicates that the 7361 is not reading the SSI transducer. (The 7361 reads the data bits as 1's when a transducer is not attached or functioning.) This is usually caused by a cabling problem between the 7361, the SSI transducer, or the transducer power supply. Check all connections and remember the following two points:

- The power supply must be connected to both the transducer and the 7361.
- The power supply must be connected to the bottom two pins of the 7361's connector.

If your wiring appears to be OK, make sure the value of the *SSI Clock Frequency* parameter is 125 KHz. Some transducers may not be able to work at the higher 500KHz setting.

### **How can I verify that my Programming Cycle code is working?**

You can always preset the Data Value, even when a transducer is not attached. Chapter 3, *SYSTEM CHECKOUT*, which starts on page 13, walks you through presetting the Data Value.

### **How do I fix problems with my Data Value?**

There are two kinds of problems that can occur with the Data Value.

#### **Data Value jumps around or appears random**

This type of problem is usually caused by the *Data Value* parameter being set to *Binary* when using a Gray Code transducer or visa versa. Start by setting the Data Value parameter to its other value. (See *%Q and %AQ Output Data Format* on page 39 for more information on programming the Data Value parameter.)

The other cause of this type of problem is the *Number of Data Bits* and/or the *MSB Bit* parameters being set incorrectly. Appendix B, *COMMON CONFIGURATIONS*, which starts on page 43, lists these parameter values for most common transducers and offers suggestions on determining these values if your transducer is not listed.†

#### **Data Value is preset at one end of travel, and it's off at the other end of travel**

This is a problem with your Scalar Multiplier and Divisor settings.

- 1) Determine your **Calculated Scale Factor** as (Scalar Multiplier / Scalar Divisor).
- 2) Determine your **Expected Travel** as (Maximum Count - Minimum Count)
- 3) Determine your **Measured Travel** as (Measured Max. Count - Measured Min. Count)
- 4) Determine your **Error Ratio** as (Expected Travel / Measured Travel)
- 5) Determine your **Actual Scale Factor** as (Calculated Scale Factor X Error Ratio)
- 6) Pick your *Scalar Multiplier* and *Scalar Divisor* to approximate your **Actual Scale Factor** as closely as possible. For example, if your Actual Scale Factor works out to be 0.459832, a Multiplier of 4,598 and Divisor of 10,000 is a much closer approximation that a Multiplier of 46 and a Divisor of 100.

† If your transducer is not listed, we'd like you to e-mail us at techsupport@amci.com with your transducer specs and 7361 parameter values so that we can include this information in the next revision.

***Why does my Data Value get corrupted and then return to normal?***

The most common cause of this is electrical noise being injected into the transducer cable that corrupts the raw SSI data. If you want to verify this, capture the raw SSI value when the Data Value is corrupted. The fix usually involves checking over your wiring and grounding to make sure the cable is kept away from high power devices and the system is grounded correctly. Refer to chapter 5, **GENERAL INSTALLATION GUIDELINES**, which starts on page 25 for more information.

***I'm using a rotary encoder. Why does the Rate of Change data occasionally spike for one scan?***

This occurs when the Data Value goes through zero. This behavior, and other issues that you should be aware of, are covered in Appendix C, **WORKING WITH ROTARY ENCODERS**, starting on page 47.

## COMMON CONFIGURATIONS

### Background

This appendix looks at several different SSI transducers and lists the parameter values needed to extract the Data Value from the SSI stream.

The only one of the *SSI Setup Parameters* not listed for the transducers is the SSI Clock Frequency. The actual frequencies that you can use is dependent on your cable length, so check with the transducer manufacturer to see what frequencies are supported in your application. As a general rule, a clock frequency of 125 KHz will work with all transducers and supports the longest cable lengths.

How you use the *Data Setup Parameters* to scale and offset the Data Value once its extracted from the SSI stream depends on your application. In general, you'll get the highest resolution from your sensor when the Scalar Multiplier and Divisor both equal 1.

**NOTE**  If you are using a rotary encoder in a continuously rotating application as opposed to a linear application, then you cannot use the Preset Value and Count Direction parameters to offset the position value or reverse the direction of counts. Refer to Appendix C, *WORKING WITH ROTARY ENCODERS*, starting on page 47, for information on performing these functions in PLC ladder logic.

### MTS Temposonics III Transducers

MTS Temposonics III magnetostrictive transducers with SSI output are available as 24 or 25 bit units with either binary or gray code output. You must determine the type of transducer that you have based on the transducer's model number before configuring the 7361. Up-to-date information on their transducers and part numbers should be on their website, [www.mtssensors.com](http://www.mtssensors.com).

MTS Temposonics III Transducers		
Parameter	24 Bit Transducer	25 Bit Transducers
MSB	1	1
Number of Data Bits	24	25
Data Type	Transducer Specific	Transducer Specific
Data Logic	Positive	Positive

Table B.1 MTS Temposonics III Parameter Values

The Temposonic III's support both SSI Clock Frequencies. Refer to figure 4.3, *Scalar Values for Linear Measurement Conversion* on page 22 for Scalar Multiplier and Divisor values to convert from metric to US customary resolutions.



### Balluff BTL-5 Transducers

Balluff’s BTL-5 magnetostrictive transducers with SSI output are available as 24 or 25 bit units with either binary or gray code output. You must determine the type of transducer that you have based on the transducer’s model number before configuring the 7361. Up-to-date information on their transducers and part numbers should be on their website, [www.balluff.com](http://www.balluff.com).

Balluff BTL-5 Transducers		
Parameter	24 Bit Transducer	25 Bit Transducers
MSB	4	5
Number of Data Bits	21	21
Data Type	Transducer Specific	Transducer Specific
Data Logic	Positive	Positive

Table B.2 Balluff BTL-5 Parameter Values

The BTL-5’s support both SSI Clock Frequencies. Refer to figure 4.3, *Scalar Values for Linear Measurement Conversion* on page 22 for Scalar Multiplier and Divisor values to convert from metric to US customary resolutions.

Balluff has an “Out of Range” error bit that is set when the magnet cannot be sensed. For 24 bit transducers this is bit 3 in the SSI stream, which is bit 23 of the double precision integer used to report the raw SSI data. For 25 bit transducers, this is bit 4 in the SSI stream, which is bit 22 of the double precision integer.

### Sick Optic DME3000 Laser Distance Sensor

Sick Optic’s DME3000 is a fully programmable distance sensor that can be set for 24 or 25 bits and either binary or gray code output. Up-to-date information on their sensor should be on their website, [www.sickoptical.com](http://www.sickoptical.com). AMCI suggests configuring the sensor for 25 bits so that a “Plausibility” error bit is available.

Sick Optic DME3000 Sensor		
Parameter	24 Bit Transfer	25 Bit Transfer
MSB	2	2
Number of Data Bits	23	23
Data Type	Gray <sup>†</sup>	Gray <sup>†</sup>
Data Logic	Positive	Positive

Table B.3 Sick Optic DME3000 Parameter Values

<sup>†</sup>Gray code is the unit’s default, but it can be configured to output binary data. If you are interfacing to a sensor that is already in use, check its programming to determine what Data Type value to use.

The DME3000’s support both SSI Clock Frequencies. The resolution of the DME3000 is 0.125 mm per count. Table B.4 shows the Scalar Multipliers and Divisors to convert this to various US customary units.

Desired Resolution	Multiplier	Divisor
0.005"	2000	2,032
0.010"	1000	2,032
0.100"	100	2,032
1.000"	10	2,032

Table B.4 DME3000 Multiplier/Divisor pairs.

**Sick Optic DME3000 Laser Distance Sensor (continued)**

The DME3000’s have a “Plausibility” error bit that is normally on and reset under fault conditions. This bit is only available when the sensor is configured for a 25 bit transfer. It is bit 25 in the SSI stream, which translates into bit 01 of the double precision integer used to report the raw SSI data.

**Stegmann AG626 Encoders**

Stegmann AG626 multi-turn encoders are 25 bit devices that offer various resolutions and either binary or gray code output. Up-to-date information on their encoder should be on their website, [www.stegmann.com](http://www.stegmann.com).

The format Stegmann uses for their data that can be a little difficult to figure out, but it remains the same for all of their encoders, regardless of the number of turns the transducer encodes or its resolution. In essence, Stegmann puts a decimal point between the 12th and 13th bit in the SSI stream. Everything to the left of the point tells you the number of turns completed. Everything to the right of the point tells you your position within the turn.

Table B.5 lists the available number of turns from Stegmann AG626 encoders and the MSB number that you must enter into the 7361. The number of data bits equals the sum of the number of bits needed for the turns data and the number of bits needed for the position within the turn data. For example, a 512 turn encoder that offers 2,048 counts per turn requires 20 bits.

$$\begin{array}{rcl}
 512 \text{ turns} & 2048 \text{ counts/turn} & \\
 2^9 & 2^{11} & \\
 9 \text{ bits} & + 11 \text{ bits} & = 20 \text{ bits}
 \end{array}$$

The *Data Logic* parameter should be always set to *Positive*.

The value of the Data Type parameter is encoder-dependent because Stegmann offers both binary and gray code encoders.

Number of Turns	MSB
2	12
4	11
8	10
16	9
32	8
64	7
128	6
256	5
512	4
1024	3
2048	2
4096	1

Table B.5 Stegmann MSB Values

### Determining Settings for an Unknown Sensor

AMCI has received calls from some customers asking for assistance in determining parameters for SSI sensors that they already have, but without a manual or datasheet. The best solution is to contact your transducer's distributor or manufacturer until you get the information you require, but AMCI recognizes that sometimes production schedules do not give you the time needed for a manual to arrive by mail.

The secret to determining parameter values is to look at the raw SSI data in the %AQ data from the 7361. The raw SSI data is stored as a double precision integer in the fifth and sixth %AQ words assigned to the module. The LSB of the SSI data is in bit one of the double precision word. As shown in figure B.1, the bottom sixteen bits of a 25 bit transfer is store in the lower word, while bits 1 through 9 are stored in the bottom half of the upper word.

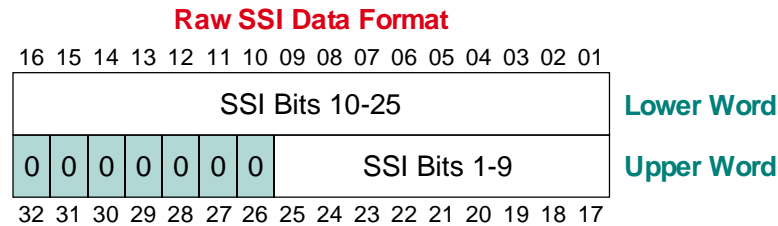

Figure B.1 Raw SSI Data Format

- 1) The first parameters that you must set correctly are the *Number of Data Bits* and *MSB Number* parameters. These values should be easy to determine by running the transducer through its full range and observing which bits change in the SSI data. However, be aware that the transducer may have status bits that change as the transducer runs through its full range. Once you determine the MSB and LSB of the data value, the difference between the two, plus one, is the number of data bits. Also, its a good idea to observe the bit pattern while slowly moving the transducer to see if the data is in binary or gray code format.
- At this point, you will start seeing numbers in your Data Value input words.
- 2) Once the *Number of Data Bits* and *MSB* parameters are set, the other two parameters to set are *Data Logic* and *Data Type*. Start by setting the Data Logic parameter to it default *Positive* value. Set the Data Type parameter to Binary unless you were able to determine that the data is in gray code format in step 2.

Hopefully, the Data Value double precision integer is stable at this point. In this case, stable means that it changes in a predictable manner. The Data Value still may not be the one you're looking for, but you should be able to solve these problems by applying the correct scalars, count direction, and presets. If the Data Value is not stable, follow these suggestions for correcting it.

- 1) Switch the value of the Data Type parameter. If this does not solve the problem, repeat step 1 above and look closely at the bit pattern to see if there are any status bits included in the Data Value. Also see if you can determine the data type from the bit pattern as you change it slowly.
- 2) If you're sure that the Data Type is binary but you have less then expected resolution, then you may be missing the LSB's of the Data Value. Increase the Number of Data Bits parameter.
- 3) If you're sure that the Data Type is gray code and the Data Value is still incorrect, then the problem usually lies in the *Number of Data Bits* and *MSB* parameters. You can pull a sub-set of binary coded data out and it will still be correct, but the conversion from gray code to binary format demands that you get the LSB of the data and all of the bits that change in SSI data. Start by changing the Number of Data Bits and MSB parameters.

## WORKING WITH ROTARY ENCODERS

### Definition of a Rotary Encoder

A rotary encoder is any device that can return to its starting value by traveling in one direction. Rotary encoders also exhibit a “roll over” condition when the output changes from its maximum value to its minimum or its minimum to its maximum. Take a Stegmann AG626 ten bit encoder for example. If you start at the zero position and continuously rotate the shaft clockwise, eventually you will return to zero. The roll over occurs when the position changes from 1,023 to 0 or from 0 to 1,023.

In contrast, a linear encoder is any device that can only return to a starting position by reversing the direction of motion. Take a MTS Temposonics III transducer for example. The transducer outputs a specific position value when the magnet is close to the transducer’s head. As the magnet travels away from the head, the position value will change, and the only way to get back to the starting position is by reversing the magnet’s motion.

#### NOTE

- 1) A linear encoder can behave as a rotary encoder if the Data Value is not extracted from the SSI stream correctly. For example, assume an eight bit linear encoder whose output ranges from 0 to 255. If you configure the Data Value to read only the bottom seven bits, its range will be zero to 127. As long as the value from the transducer is 127 or less, the system will be correct. As soon as the position becomes 128 however, the Data Value will return to zero.
- 2) A rotary encoder can behave like a linear encoder if it is not allowed to pass through its physical zero point. This is usually difficult to accomplish, because the transducer’s shaft must be set correctly before the transducer is mounted on the machine.

### Definition of Full Scale Count

In order to reverse the count direction or offset the value of a rotary encoder, you need to know the number of counts the encoder produces. AMCI calls this value the encoder’s *Full Scale Count*. For example, a 12 bit single-turn encoder has a Full Scale Count of 4,096. If the resolution of the encoder is changed to 0.1° with a Scalar Multiplier/Divisor of 3600/4096, then the Full Scale Count becomes 3600.

### Ladder Logic Examples

This appendix contains ladder logic examples to reverse the count direction and offset the Data Value (position) of a rotary encoder. Both of the samples are written to work with the ladder logic sample given in chapter 3, *SYSTEM CHECKOUT*. The sample is given in the *Add Ladder Logic* section of the chapter starting on page 14.

### Reversing The Count Direction

Reversing the count direction of a rotary encoder is a two step process. First, if the Data Value is zero, do nothing. If the Data Value is non-zero, then the Data Value becomes (Full Scale Count - Data Value).

#### Memory Needed

The ladder logic requires two double precision registers. The first contains the buffered Data Value from the 7361. The second contains the Full Scale Count.

- **%R15-16: Buffered Position.** This is the buffered Data Value read from the 7361. It will also contain the reversed count when the ladder logic is complete.
- **%R21-22: Full Scale Count.** This register holds the Full Scale Count value, which is equal to: (Maximum Data Value count + 1).
- **%M19: Reverse Count Direction Bit.** When this bit is set, the ladder logic will reverse the count direction of the transducer. Leaving this bit reset prevents the count direction from being reversed. This bit is the equivalent of the Count Direction bit of the 7361.

## Reversing The Count Direction (continued)

### Ladder Logic

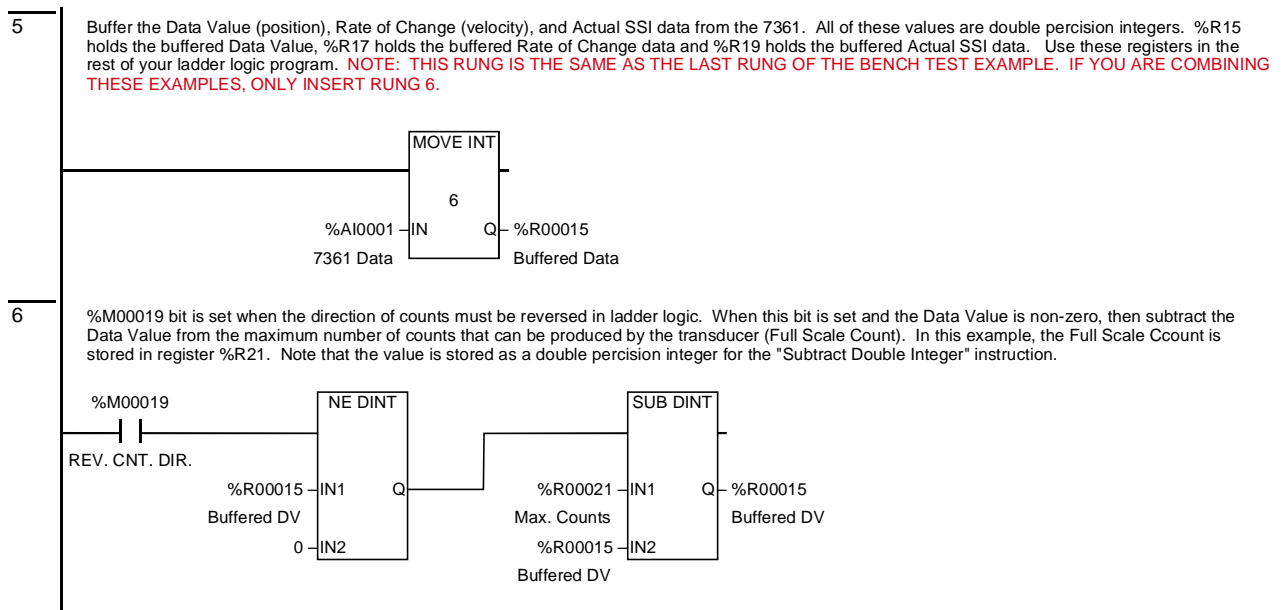

Figure C.1 Ladder Logic: Reversing Count Direction

### Offsetting the Data Value

Offsetting the Data Value involves calculating the offset needed to bring the Data Value to a known value when an internal "Preset Data Value" bit is set and then applying the offset to the Data Value every scan.

If you are reversing the count direction *and* offsetting the data value, then reverse the count direction first. The two examples in this appendix were written so that they could be combined.

### Memory Needed

The ladder logic requires four double precision registers and two bits. The registers used for Buffered Position and Full Scale Count are the same registers used in the previous examples.

- **%R15-16: Buffered Position.** This is the buffered Data Value read from the 7361. It will also contain the offset position when the ladder logic is scanned.
- **%R21-22: Full Scale Count.** This register holds the Full Scale Count value, which is equal to: (Maximum Data Value count + 1).
- **%R23-24: Desired Position.** This register holds the position that you want the current position to become when a new offset is calculated and applied. The range of this value is: 0 to (Full Scale Count -1). This register is the equivalent of the 7361's *Preset Value* parameter.
- **%R25-26: Internal Offset.** This is the calculated offset that is applied to the Buffered Position on every scan.
- **%M20: Calculate Offset.** Set this bit to calculate a new Internal Offset.
- **%M21: One Shot.** This bit is used in a one-shot to make sure that the Internal Offset is only calculated once if the Calculate Offset bit remains set for more than one scan.



## Offsetting the Data Value (continued)

### Ladder Logic

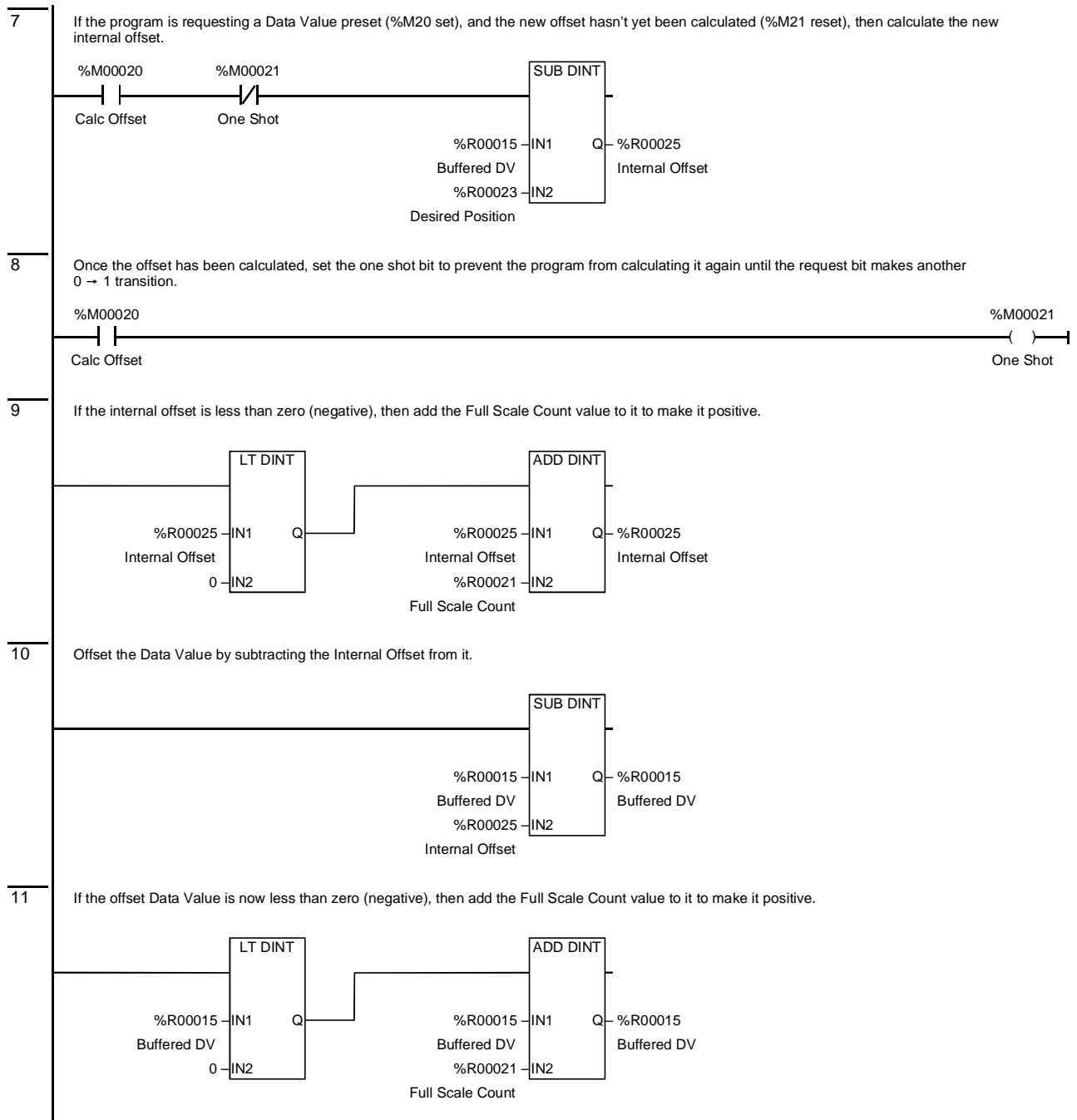

Figure C.2 Ladder Logic: Offsetting a Circular Data Value



### ***Notes on Rate Of Change Data***

The 7361 calculates the Rate of Change, which is velocity in rotary application, as the change in position over the programmed update time. Whenever the rotary encoder rolls over, the 7361 sees a very large change in position in one update time. For example, consider a 15 bit single-turn encoder that rotates at a rate of 1 count per 24 milliseconds. With the Rate Update time set at 24 milliseconds, the Velocity will read 42 counts per second ( $1,000\text{ms} * 1\text{count}/24\text{ms}$ ), until the encoder goes through zero. At that point, the 7361 sees a 32,767 count difference in 24 milliseconds and sets the velocity to ( $1,000\text{ms} * 32,767\text{counts}/24\text{ms}$ ) = 1,365,333 counts per second for one update time.

If you are using the velocity data from the 7361, you should first calculate the maximum speed of your machine and write your ladder logic to ignore any velocity data from the 7361 that exceeds this value.



## *Notes*





***ADVANCED MICRO CONTROLS INC.***

20 GEAR DRIVE, TERRYVILLE, CT 06786 T: (860) 585-1254 F: (860) 584-1973

---

[www.amci.com](http://www.amci.com)

---

**LEADERS IN ADVANCED CONTROL PRODUCTS**