The NX1F4X is a four axis stepper controller that appears as a node on a network. The available networks, along with the corresponding AMCI part numbers, are shown in the following table.

Network	Part Number
ControlNet	NX1F4C
DeviceNet	NX1F4D
Ethernet	NX1F4E
Profibus	NX1F4P
Modbus TCP/IP	NX2A4T

This unit receives profile data from the network and outputs step and direction signals or Clockwise/Counter Clockwise pulses to a stepper driver. Inputs on the module allow homing and emergency stop operations. A differential incremental encoder can be attached to the unit to provide feedback information.

The NX1F4X uses 32 16 bit input words (34 will be required in a ControlNet ControlLogix system) and 32 16 bit output words to communicate with the network. The four channels are totally independent from each other and can be configured and programmed to perform different operations.

32-bit parameters are divided into two words, the Most Significant Word (MSW) and the Least Significant Word (LSW). The upper word (MSW) has the 1000s places and the lower word (LSW) has the 1s, 10s and 100s places. Negative values use a sign magnitude format. That is, the Most Significant Bit in the Most Significant Word will be set to indicate a negative value. For example:

Value	MSW (decimal)	LSW (decimal)
-12,345	-32756	345
12,000	12	0
-12,000	-32756	0
345	0	345
-345	-32768	345

Because the NX1F4X module does not use a non-volatile memory, it must be configured at every power up.

Sample programs showing how to program the NX1F4X module are available from the following page of our website.

<https://www.amci.com/industrial-automation-support/sample-programs/>

General Information

Important User Information

The products and application data described in this manual are useful in a wide variety of different applications. Therefore, the user and others responsible for applying these products described herein are responsible for determining the acceptability for each application. While efforts have been made to provide accurate information within this manual, AMCI assumes no responsibility for the application or the completeness of the information contained herein. Throughout this manual the following two notices are used to highlight important points.

WARNINGS tell you when people may be hurt or equipment may be damaged if the procedure is not followed properly.

CAUTIONS tell you when equipment may be damaged if the procedure is not followed properly. No patent liability is assumed by AMCI, with respect to use of information, circuits, equipment, or software described in this manual. The information contained within this manual is subject to change without notice. UNDER NO CIRCUMSTANCES WILL ADVANCED MICRO CONTROLS, INC. BE RESPONSIBLE OR LIABLE FOR ANY DAMAGES OR LOSSES, INCLUDING INDIRECT OR CONSEQUENTIAL DAMAGES OR LOSSES, ARISING FROM THE USE OF ANY INFORMATION CONTAINED WITHIN THIS MANUAL, OR THE USE OF ANY PRODUCTS OR SERVICES REFERENCED HEREIN.

Standard Warranty

ADVANCED MICRO CONTROLS, INC. warrants that all equipment manufactured by it will be free from defects, under normal use, in materials and workmanship for a period of [18] months. Within this warranty period, AMCI shall, at its option, repair or replace, free of charge, any equipment covered by this warranty which is returned, shipping charges prepaid, within one year from date of invoice, and which upon examination proves to be defective in material or workmanship and not caused by accident, misuse, neglect, alteration, improper installation or improper testing. The provisions of the "STANDARD WARRANTY" are the sole obligations of AMCI and excludes all other warranties expressed or implied. In no event shall AMCI be liable for incidental or consequential damages or for delay in performance of this warranty.

Returns Policy

All equipment being returned to AMCI for repair or replacement, regardless of warranty status, must have a Return Merchandise Authorization number issued by AMCI. Call (860) 585-1254 with the model and serial numbers along with a description of the problem. A "RMA" number will be issued. Equipment must be shipped to AMCI with transportation charges prepaid. Title and risk of loss or damage remains with the customer until shipment is received by AMCI.

24 Hour Technical Support Number

Technical Support, in the form of documents, FAQs, and sample programs, is available from our website, www.amci.com. 24 Hour technical support is also available on this product. For technical support, call (860) 585-1254. Your call will be answered by the factory during regular business hours, Monday through Friday, 8AM - 5PM EST. During non-business hours, an automated system will ask you to leave a detailed message and the telephone number where you can be reached. The system will page an engineer on call. Please have your product model number and a description of the problem ready before you call.

Hardware Overview	Chapter 1	4
Power Requirements & LED Functions		4
Module Specifications		5
Output Signals		6
Wiring		6
Dimensions & Mounting		9
Breakout Box Dimensions		10
Calculating Move Profiles	Chapter 2	11
Configuration Programming	Chapter 3	13
Configuration Bits		15
Input Active Level		15
Starting Speed		17
Invalid Configurations		17
Configuration Mode Input Data		18
Command Mode Operations	Chapter 4	19
Absolute & Relative Moves		19
Hold Move		19
Resume Move		20
Immediate Stop		20
Find Home +/(CW), Find Home -(CCW)		20
Manual Move +/(CW), Manual Move -(CCW)		23
Preset Current Position		24
Reset Errors		24
Preset Encoder Position		24
Blend Move		25
Blend Move Programming		26
Encoder Registration Move		27
Master / Slave Mode		28
Encoder Follower		29
Registration Move		30
Acceleration Types		31
Command Mode Output Data	Chapter 5	32
Command Words		32
Command Bits		34
Command Mode Input Data	Chapter 6	36
Input Word Functions		36
Status Bits		37
Status & Error Bit Functions		38
Network Connections	Chapter 7	41
NX1F4C (ControlNet)		41
NX1F4D (DeviceNet)		44
NX1F4E (Ethernet IP)		46
NX1F4P (Profibus)		47
Siemens S7		49
NX1F4T (Modbus TCP IP)		52
Changing IP Address	Chapter 8	54
Manual Revision History	Chapter 9	57

Chapter 1: Hardware Overview

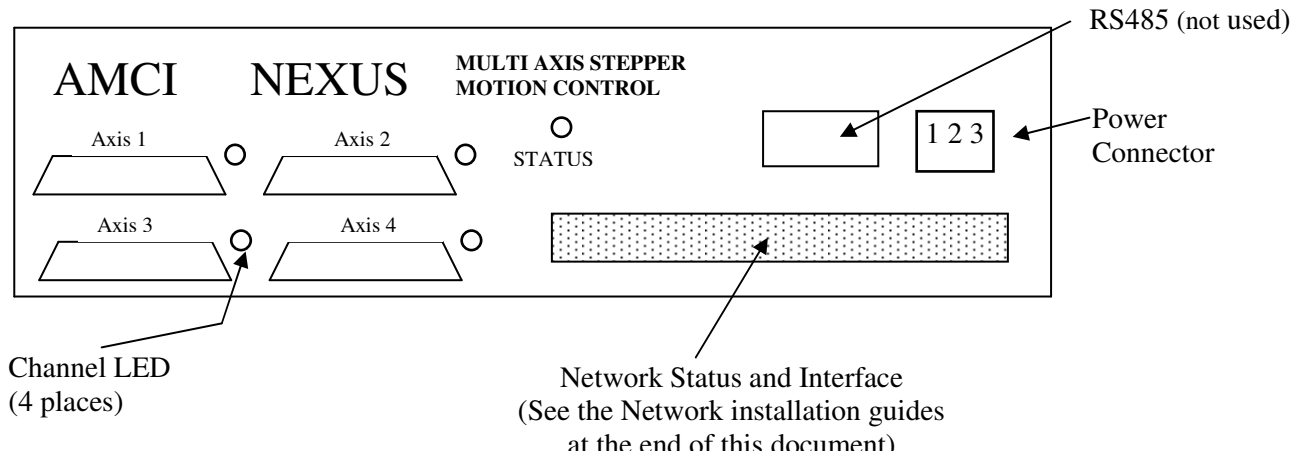

Power Requirements

Power Connector

Pin	Function
1	10 to 30Vdc
2	DC Common
3	Chassis Ground

- The NX1F4X requires 1Amp @24Vdc to operate.
- 24Vdc is the recommended power supply voltage level. 30Vdc is the absolute maximum level.
- The Chassis Ground Pin is connected to the NX1F4X's body and must be connected to your earth ground bus for proper module operation.

NX1F4X LED Function

LED	Function
Status	Solid Green: Unit OK
	Flashing Green: Unit OK, but not communicating with the network
	Solid Red: Module Fault or Unit initializing. Initialization should last about 8 seconds after power up
	Flashing Red/Green: NX1F4X can't communicate with Network board
Channel	Solid Green: Channel OK, no motion in progress
	Flashing Green: Channel OK, motion occurring Slave Mode or Encoder Follower Mode Enabled
	Solid Red: Configuration Error or Command Error
	Flashing Red: Command Error Detected while motion is occurring. When the move is complete, the LED changes to solid Red.

Module Specifications

Environmental Conditions

Operating Temperature: 0 to 60° C
Relative Humidity: 5 to 95% (non-condensing)
Storage Temperature: -40 to 85° C

Stepper Outputs

5V differential line driver (3.5V to 4V typical output level)
Maximum Output Current: 20mA
Maximum Output Frequency: 250KHz

Encoder Inputs

5V differential encoder only
A, B, and Z Maximum Input Current: 10mA per channel @5Vdc
A, B, and Z Maximum Input Frequency = 1MHz
5Vdc supply: 200mA maximum

CW Limit Switch, CCW Limit Switch, Home Limit Switch Sinking Inputs

Input Voltage Range: 7 to 24Vdc
Input Current: 5mA
Response Time: 500μs

External Input Sinking Input (used for Controlled Stop or Encoder Capture operations)

Input Voltage Range: 7 to 24Vdc
Input Current: 5mA
Response Time: 10μs

Emergency Stop Differential Input

Input Voltage Range: 7 to 24Vdc
Input Current: 5mA
Response Time: 500μs

Throughput Time

The NX1F4X has a throughput time of 1ms. This is the time between when a command is received and acted upon.

Direction of Travel

The point of reference for determining the direction of travel is looking at the motor's shaft.

Output Signals

The NX1F4X module can be programmed to output either Step and Direction signals or CW / CCW steps. There is no advantage to either type; you must simply configure the NX1F4X module to match the input type of your driver. The two types of signals are illustrated below.

Step and Direction Output

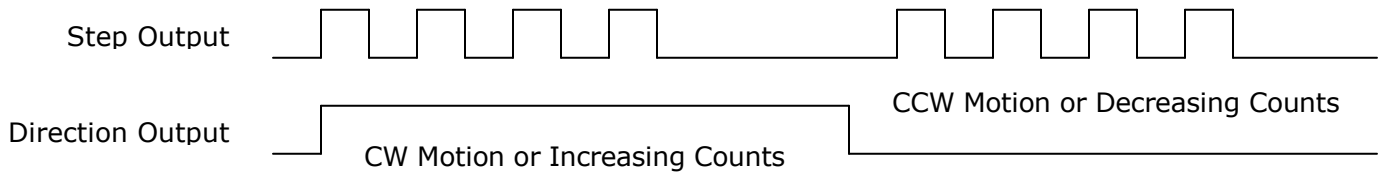

CW and CCW Step Outputs

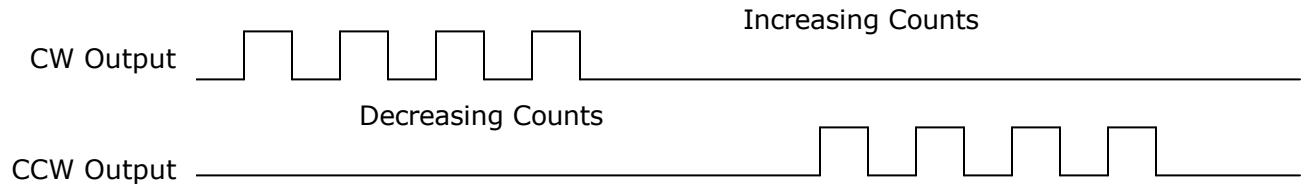

Wiring

A breakout box is used to field connect the NX1F4X's to its input and output signals. A three foot 25 pin interface cable is used to connect the NX1F4X to the breakout box. Four breakout boxes and cables, one for each channel, are included with each NX1F4X.

The following tables show the wiring of the breakout box.

Pinout Connections of Breakout Box By Function

Pin #	Function
1	+A Encoder Input
14	-A Encoder Input
2	+B Encoder Input
15	-B Encoder Input
3	+Z Encoder Input
16	-Z Encoder Input
4	+5Vdc Encoder Supply 200ma Max
17	Encoder Common
5	No Connection
18	External Input
6	CW Limit Switch
19	CCW Limit Switch
7	Home Limit Switch

Pin #	Function
20	Input Common
8	Emergency Stop +
21	Emergency Stop -
9	No Connection
22	No Connection
10	+Step/CW output
23	-Step/CW output
11	+Direction/CCW output
24	-Direction/CCW output
12	Shields
25	No Connection
13	No Connection

Pinout Connections of Breakout Box by Pin Number

Pin #	Function
1	+A Encoder Input
2	+B Encoder Input
3	+Z Encoder Input
4	+5Vdc Encoder Supply 200ma Max
5	No Connection
6	CW Limit Switch
7	Home Limit Switch
8	Emergency Stop +
9	No Connection
10	+Step/CW output
11	+Direction/CCW output
12	Shields
13	No Connection

Pin #	Function
14	-A Encoder Input
15	-B Encoder Input
16	-Z Encoder Input
17	Encoder Common
18	External Input
19	CCW Limit Switch
20	Input Common
21	Emergency Stop -
22	No Connection
23	-Step/CW output
24	-Direction/CCW output
25	No Connection

Wiring Notes:

- The NX1F4X module uses a 9638 differential line driver in series with a 10Ω resistor for the stepper (+/- step and +/- direction) outputs.
- A Beldin 8302 or equivalent cable can be used to connect the step / direction outputs to your stepper driver.
- Stepper signals are generally low voltage, low power signals. A cable carrying stepper signals can be installed in conduit along with other low power cabling such as communication cables and low power ac/dc I/O lines. It cannot be installed in conduit with ac power lines or high power ac/dc I/O lines.
- To reduce or eliminate the influence of electrical noise on the system, the step and direction cable shields should be connected to shield pin 12 of the NX1F4X's break out box. This pin is also connected to the Chassis ground terminal of the three pin power connector.
- The cable shields must be connected to only one end of the cable run and treated as conductors at any junctions. Do not ground the shields at the junction box.
- If the signal cable must cross power feed lines, it should do so at right angles.
- Route the cable at least five feet from high voltage enclosures, or sources of "rf" radiation.
- The Input Common should be connected to the COM of the supply that powers the discrete inputs. A Stepper Driver with Single Ended Step and Direction inputs can also be referenced here.

Single Ended Input Wiring

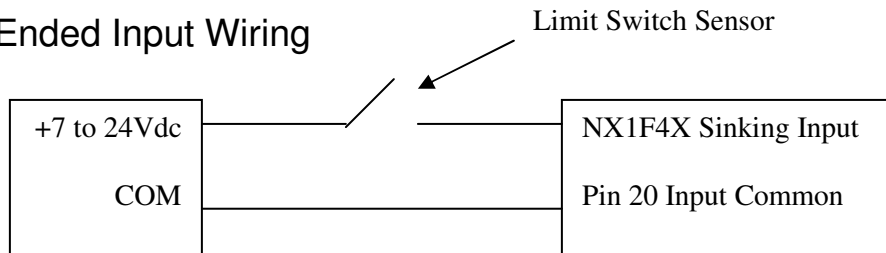

Note: When using the Emergency Stop input, the Common Terminal must be connected pin 21.

Single Ended Encoder Wiring

The NX1F4X module is designed to work with +5Vdc differential encoders. Use the following table and diagrams to attach single ended encoders to the NX1F4X module. A current limiting resistor R_{Lim} must be installed for encoders that do not operate at 5Vdc.

Encoder's External Power Supply	Current Limiting Resistor R_{Lim}
5Vdc	none
12Vdc	1K Ω
15Vdc	1.2K Ω
24Vdc	2.7K Ω

NX1F4X Encoder Inputs

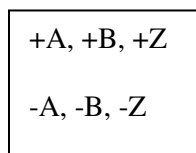
 R_{Lim}

Sourcing Output Encoder

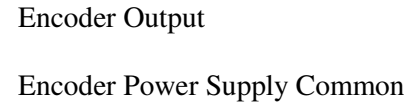

NX1F4X Encoder Inputs

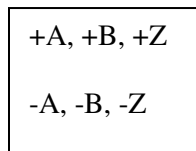
 R_{Lim}

Sinking Output Encoder

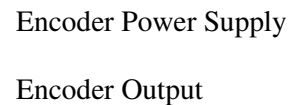

Diagnostic Feedback Wiring

The following table shows how to wire the NX1F4X at the breakout box for Diagnostic Feedback.

Pin Connections	Pin Connections
10 to 1	+Step to +A
23 to 14	-Step to -A
11 to 2	+Direction to +B
24 to 15	-Direction to -B

Dimensions and Mounting

Mounting

The NX1F4X can be either DIN rail or panel mounted. The mounting kit, included with the unit, contains two DIN brackets, two panel brackets, and four #8 screws needed to attach your choice of brackets to the NX1F4X.

Note: The NX1F4X enclosure is not sealed and it must be installed in an adequate enclosure to protect it from environmental contaminants.

The following diagrams show the dimensions of the two DIN rail, either bottom or rear, mounting options.

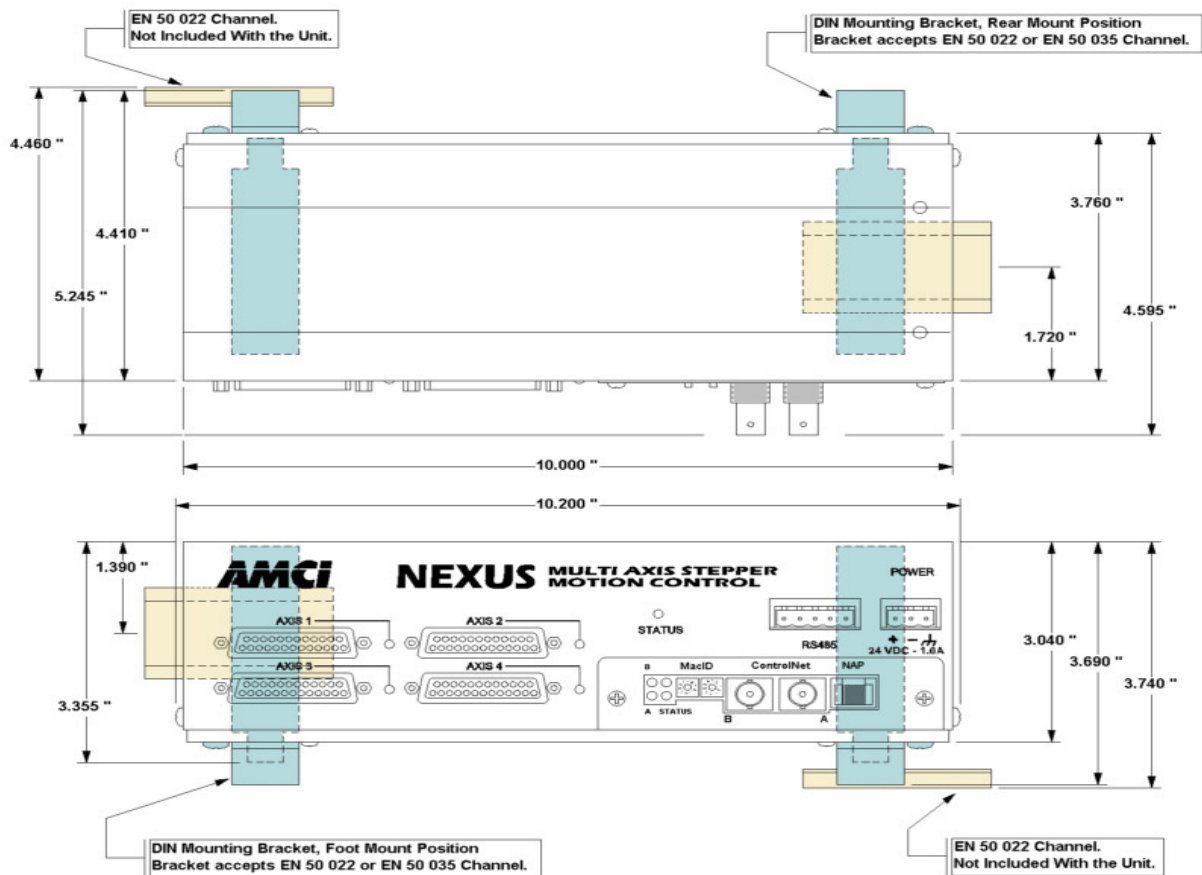

Attaching the DIN brackets to the NX1F4X

1. Remove a DIN bracket, two #8 screws, and two #8 washers from the mounting kit bag.
2. Slide the DIN bracket onto the unit.
3. Install the two #8 screws and lock washers to secure the bracket on the unit.
4. Repeat on the other side.

The following diagrams show the dimensions of the two panel, either bottom or rear, mounting options.

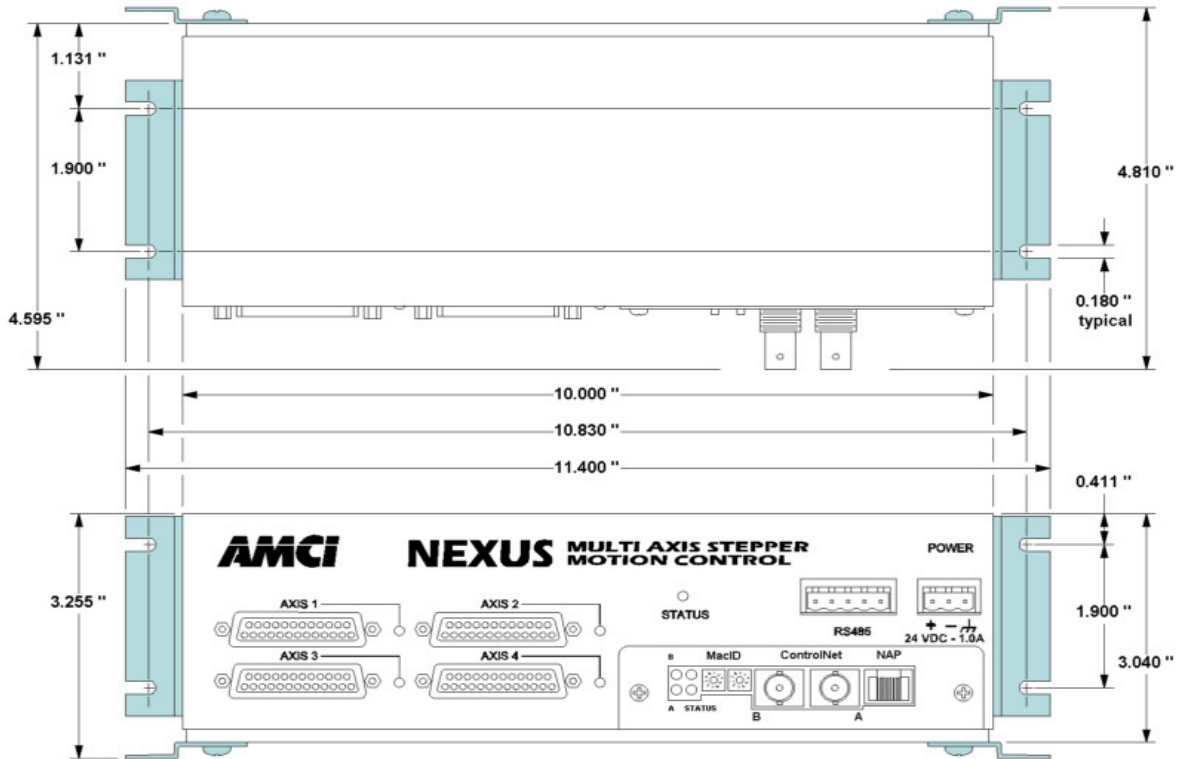

Attaching the panel brackets to the NX1F4X

1. Remove a panel bracket, two #8 screws, and two #8 lock washers from the mounting kit bag.
2. Position the panel bracket onto the unit.
3. Install the two #8 screws and lock washers to secure the bracket to the unit.
4. Repeat on the other side.

Breakout Box Dimensions (four included with each NX1F4X)

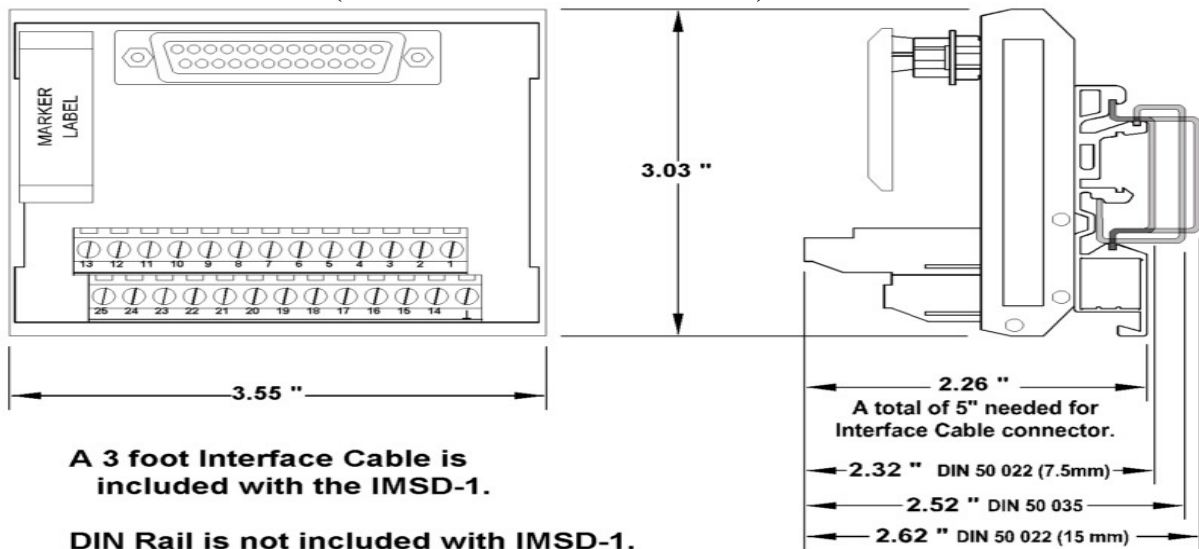

Chapter 2: Calculating Move Profiles

Before starting a move operation, the NX1F4X module completely calculates each portion of the move profile. That is, it calculates how many steps of the move profile will be required for acceleration and how many steps will be required for deceleration. Depending on the data used to define the move profile, this can result in two types of velocity profiles, either a *Trapezoidal Profile* or a *Triangular Profile*.

A *Trapezoidal Profile* jumps from rest to the Starting Speed, accelerates to the Programmed Velocity at the commanded acceleration rate, continues at the Programmed Velocity to a predetermined point, and then decelerates to the target position at the commanded deceleration rate to the starting speed and stops.

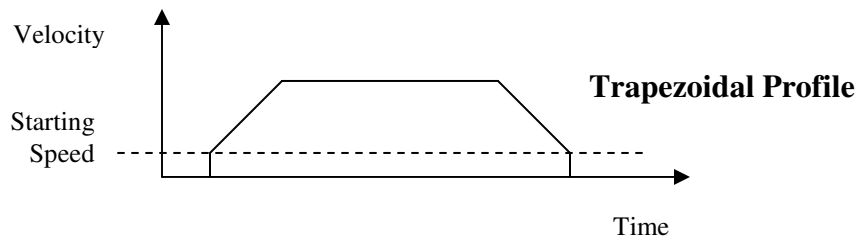

However, if the length of a commanded move is not long enough to attain the programmed velocity before the deceleration point is reached, a *Triangular Velocity* profile will be generated.

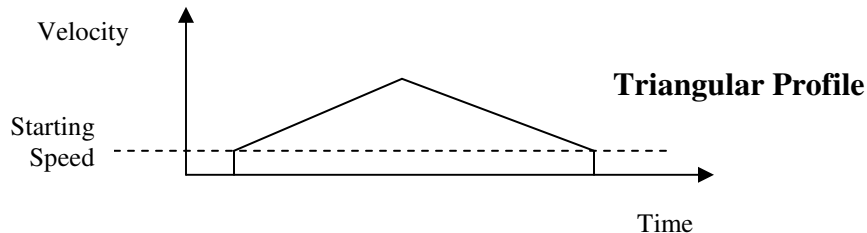

Regardless of the type of Velocity Profile that is being run, the following equations can be used to determine both the time to accelerate and the number of steps needed to accelerate. These formulas can also be used to calculate the time and distance to decelerate.

$$T_a = (V_s - V_o)/a$$

$$D_a = T_a * (V_o + V_s)/2$$

V_o = Starting Speed (steps/second)

V_s = Programmed Speed (steps/second)

T_a = Time to accelerate (seconds)

D_a = Distance to accelerate (steps)

a = Acceleration rate (steps/second/second)

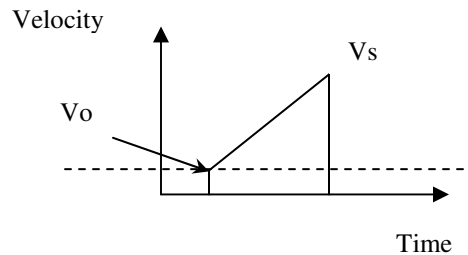

The acceleration rate entered in these equations must have units of steps/second/second, not the steps/ms/second used by the NX1F4X module. See the Calculation Notes below for a complete explanation.

Calculation Notes

1. The acceleration and deceleration values sent to the NX1F4X module as part of the move profile have units of steps/ms/sec.

If you are using the above formulas to calculate T_a (the time to accelerate), multiply the acceleration value sent to the NX1F4X module by 1000 before using it in the formulas.

If you are using the above formulas to calculate the acceleration rate from a desired Time to accelerate, divide the result of the calculation by 1000 before using it as the acceleration parameter sent to the NX1F4X module.

2. If the number of steps to accelerate plus the number of steps to decelerate is greater than the number of steps programmed in the target position registers, than the NX1F4X module will run a *Triangular Velocity Profile*.
3. If the number of steps to accelerate plus the number of steps to decelerate is less than the number of steps programmed in the target position, than the NX1F4X module will run a *Trapezoidal Velocity Profile*.

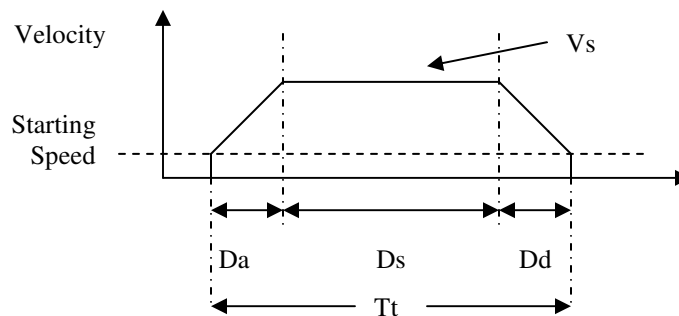

$$D_s = (\text{Total Number of Steps}) - (D_a + D_d)$$

$$T_t = T_a + T_d + D_s/V_s$$

D_a = Distance to Accelerate (steps)

D_s = Distance at the programmed speed (steps)

D_d = Distance to decelerate (steps)

V_s = Programmed Speed (steps/sec)

T_t = Total Profile Time (seconds)

Starting Speed

The starting speed has a range of 1 to 250,000 pulses/sec and is the pulse frequency at which every move begins and ends. That is, the first and last pulses of the move profile will be at the starting speed.

Please note that configuring the NX1F4X module with a very low starting speed will increase the length of time between two consecutive moves.

Although it is not necessary, the smoothest transition from rest to the programmed speed will be achieved with a Starting Speed equal to the square root of the acceleration value.

Chapter 3: Configuration Programming

The Configuration Mode provides the ability to select the proper setup configuration to match the stepper application without having to set any switches.

Because the NX1F4X does not contain a Non Volatile Memory, it powers up and stays in Configuration mode until a valid configuration file has been sent to the each of the channels.

This configuration file, which consists of four words on each channel, is used to define the following parameters.

1. If a CCW Limit Switch will be used and its input active state
2. If a CW Limit Switch will be used and its input active state
3. If an External Input will be used and its active state.
4. The function of the External Input, whether it will be used to perform a controlled stop or to capture encoder data.
5. If a Home Limit Switch will be used and its input active state
6. If a Quadrature Encoder will be used with the system
7. If the channel will be configured for Diagnostic Feedback. Diagnostic Feedback allows the unit to count its own output pulses by wiring the outputs to the encoder inputs.
8. The output type, either CW and CCW Pulses or Pulse and Direction.
9. The type of homing operation that will be performed. The three options are to a Home Limit Switch only, to a Home Limit Switch (acting like a Proximity switch) and Marker Pulse, or to a Marker Pulse Only. Either of the Marker Pulse options also requires the presence of the Quadrature Encoder.
10. The Starting Speed. The starting speed is the pulse frequency that every move begins and ends at. Some portions of the homing operations are also performed at the starting speed

Configuration Mode Output Data

While in configuration mode, the output registers have the following format.

Word	Channel	Configuration Output Data	Units	Range
0	1	Configuration Bits		See Description Below
1	1	Input Active Levels		See Description Below
2	1	MSW Start Speed	Steps/Second	1 to 250,000
3	1	LSW Start Speed		
4	1	0		
5	1	0		
6	1	0		
7	1	0		
8	2	Configuration Bits		See Description Below
9	2	Input Active Levels		See Description Below
10	2	MSW Start Speed	Steps/Second	1 to 250,000
11	2	LSW Start Speed		
12	2	0		
13	2	0		
14	2	0		
15	2	0		
16	3	Configuration Bits		See Description Below
17	3	Input Active Levels		See Description Below
18	3	MSW Start Speed	Steps/Second	1 to 250,000
19	3	LSW Start Speed		
20	3	0		
21	3	0		
22	3	0		
23	3	0		
24	4	Configuration Bits		See Description Below
25	4	Input Active Levels		See Description Below
26	4	MSW Start Speed	Steps/Second	1 to 250,000
27	4	LSW Start Speed		
28	4	0		
29	4	0		
30	4	0		
31	4	0		

Channel 1 Word 0, Channel 2 Word 8, Channel 3 Word 16, and Channel 4 Word 24:

- bit 0: set when a CCW Limit Switch will be used
- bit 1: set when a CW Limit Switch will be used
- bit 2: reserved
- bit 3: set when an External Input is used. The external input can be used to stop a Manual Move operation, or to place an Absolute or Relative move in a hold state.
- bit 4: set when a Home Limit Switch Input will be used. If both this bit and bit 12 (marker pulse homing) are set, than the Home Limit Switch will act as a proximity limit switch.
- bit 5: set when an Emergency Stop Input will be used
- bit 6: "0" if the External Input will be used to stop a manual move operation or hold an absolute or relative move, "1" if the External input will be used to trap the optical encoder data.
- bit 7: reserved for future use
- bit 8: set when quadrature encoder will be used
- bit 9: set when diagnostic feedback will be used
- bit 10: "1" when output pulse type is pulse train and direction
"0" when output pulse type is CW pulse train and CCW pulse train
- bit 11: reserved for future use
- bit 12: "0" for limit switch home operations
"1" for marker pulse home operations
- bits 13 & 14: reserved for future use
- bit 15: "1" for configuration mode operations
"0" for command mode operations

<p>Note: The ability to home the module and either the CW or CCW limit switches must be configured. However, they do not have to actually be used in the stepper application.</p>
--

Channel 1 Word 1, Channel 2 Word 9, Channel 3 Word 17, and Channel 4 Word 24:

Defines the active level of the inputs. These bits will be set for high level active or Normally Open (NO) (current is supplied to the input when it is active), or reset for low level active or Normally Closed (NC) (current is removed from the input when it is active). The active level of the inputs is taken into account only when the input has been defined as being present in word 0 or word 8.

- bit 0: determines the active level of the CCW Limit Switch
- bit 1: determines the active level of the CW Limit Switch
- bit 2: reserved for future use and must be zero
- bit 3: determines the active level of the External Input
- bit 4: determines the active level of the Home Limit Switch Input
- bit 5: determines the active level of the Emergency Stop Input
- bits 6 to 15: reserved for future use and must be zero

Input Active Level

Set these bits to define the input(s) to be active high (for use with a normally open contact) reset these bits to define the input(s) to be Active Low (for use with a normally closed contact). Please note that the active level of the inputs is taken into account only when the input has been defined as being used.

Set the bits of any inputs that are being configured but not used so that the Input Active Level is Active High.

Emergency Stop

The Emergency Stop Input causes the current move operation to stop without any deceleration. The pulse signal is simply stopped. If the channel was moving when this command was issued, the current position will become invalid, and the Position Invalid Input Bit will be set. The channel will have to be Preset or Homed again before an Absolute Move operation can be performed. However, it will still be possible to perform a Relative or a Manual Move after the Emergency Stop Input has been used.

External Input

The External Input has six uses.

1. During a manual move the stepper motor will decelerate to the starting speed, and stop, while keeping track of the current position.
2. During an absolute or relative move, the External Input will cause the module to make a controlled stop to a hold state.
3. The External Input will stop the motion of a channel that is operating as a slave.
4. The External Input will stop the motion of a channel acting as an Encoder Follower.
5. The External Input will cause the number of steps programmed in the Target Position registers to be output at the end of the Registration Move.
6. If configuration bit 6 was set during the configuration operation, the External Input will capture the encoder data. I
7. The transition of the External Input and the current motor position can be captured on NX1F4X-06 units (This functionality is not available on NX1F4X units without the -06 option.) When the External Input Latch Enable/Clear Output bit is set, the External Input Latch Status bit will be set when the External Input becomes active. This status bit will remain set, even if the External Input becomes inactive, until the External Input Latch Enable/Clear bit is reset. The following diagram illustrates this functionality.

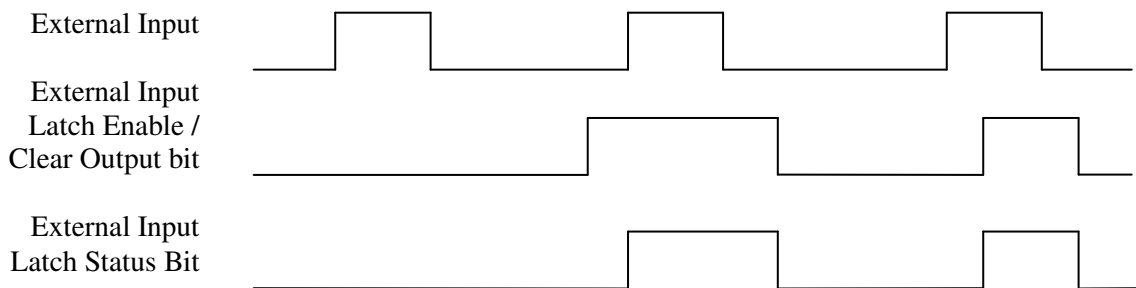

Note 1: The state of the External Input Latch Enable / Clear bit and the External Input Latch Status bit has no affect on the Captured Encoder value.

Note 2: The current position will only be captured if the NX1F4X-06 has not been configured to use an encoder

Optical Encoder

The optical encoder has a range of $\pm 8,388,607$ counts and uses X4 decoding. Only a 5V differential encoder will work with the NX1F4X. A move profile does not have to be in progress in order for the unit to count encoder pulses.

Starting Speed

The starting speed has a range of 1 to 250,000 pulses/sec and is the pulse frequency at which every move begins and ends. Some portions of the homing operations are also performed at the starting speed. The starting speed is divided into two words. The Most Significant Word contains the 1000s places and the Least Significant Word contains the 1s, 10s, and 100s places. For example, if the desired starting speed is 1234 pulses/sec, then the Most Significant Word would be 1 and the Least Significant Word would be 234. The following table shows the location of the starting speed on the NX1F4X's four channels.

Channel	Word	Function
1	2	Most Significant Word of the Starting Speed
1	3	Least Significant Word of the Starting Speed
2	10	Most Significant Word of the Starting Speed
2	11	Least Significant Word of the Starting Speed
3	18	Most Significant Word of the Starting Speed
3	19	Least Significant Word of the Starting Speed
4	26	Most Significant Word of the Starting Speed
4	27	Least Significant Word of the Starting Speed

Invalid Configurations

The NX1F4X will not accept all possible configurations. The following is a list of the invalid configurations:

1. A configuration without the ability to home the module, Home Limit Switch only, Marker Pulse Only, or Marker Pulse and Home Limit Switch (acting as a proximity limit switch).
2. A configuration without at least one End Limit Switch, either CW or CCW.

Note: The ability to home the module and at least one of the end limit switches have to be configured. They do not have to actually be used in the stepper application.

3. Using Quadrature Encoder and Diagnostic Feedback.
4. Using a Marker Pulse Home without the Quadrature Encoder.
5. Diagnostic Feedback with CW and CCW pulse outputs.
6. A starting speed outside the range of $1 \leq \text{starting speed} \leq 250,000$.
7. The least significant word of the starting speed is outside of the range of 0 to 999.
8. Setting the module for Encoder Trapping without configuring the module to use the encoder.
9. Setting any of the unused bits in the configuration words.
10. Any value other than zero in the unused configuration words.

The NX1F4X has to be configured before starting any operations. On power up, or when the Configuration Mode flag is set in the output registers, the stepper controller enters Configuration Mode. When in this mode, the stepper controller will stop its operations and set the Configuration Mode flag in the input registers. It then waits for the configuration file to be transferred over the network. If there is no current Configuration File present or if the transferred Configuration File is not valid, the Configuration Error Input bit will be set. If the transferred configuration file is accepted, and if it is different from the current configuration, the configuration data will be mirrored in the input registers. While in configuration mode, the input registers have the following format.

Configuration Mode Input Data

Note: A ControlLogix system using ControlNet will require 34 input words. The first two words will always be zero, and the channel 1 Configuration Bits and Status will be located in input word 2.

Input Word	Channel	Configuration Input Data
0	1	Configuration Bits and Status
1	1	Input Active Levels
2	1	MSW Starting Speed
3	1	LSW Starting Speed
4	1	0
5	1	0
6	1	Major Firmware Revision #
7	1	Minor Firmware Revision #
8	2	Configuration Bits and Status
9	2	Input Active Levels
10	2	MSW Starting Speed
11	2	LSW Starting Speed
12	2	0
13	2	0
14	2	Major Firmware Revision #
15	2	Minor Firmware Revision #
16	3	Configuration Bits and Status
17	3	Input Active Levels
18	3	MSW Starting Speed
19	3	LSW Starting Speed
20	3	0
21	3	0
22	3	Major Firmware Revision #
23	3	Minor Firmware Revision #
24	4	Configuration Bits and Status
25	4	Input Active Levels
26	4	MSW Starting Speed
27	4	LSW Starting Speed
28	4	0
29	4	0
30	4	Major Firmware Revision #
31	4	Minor Firmware Revision #

Channel 1 Word 0, Channel 2 Word 8, Channel 3 Word 16, and Channel 4 Word 24:

- bits 0 → 6, 8 → 10, and 12 mirror output word zero configuration data
- bits 7 and 11, not used
- bit 13: Set when there is a Configuration Error
- bit 14: Module OK: “1” when the NX1F4X module is operational, “0” when the module has encountered a fatal error
- bit 15: “1” when in configuration mode, “0” when in command mode

Channel 1 Word 1, Channel 2 Word 9, Channel 3 Word 17, and Channel 4 Word 25:

- bits 0 → 5: mirror of bits 0 to 5 in Output Word 1 and 9
- bits 6 → 15: reserved for future use

Chapter 4: Command Mode Operations

The following is a description of the various commands that the module accepts and the operations that it will perform while in Command Mode.

Absolute/Relative Move

The current position must to be valid in order to perform an ABSOLUTE MOVE. A HOME or PRESET operation will have to be performed before the position becomes valid. The distance moved, that is the number of pulses issued by the NX1F4X, is equal to the difference between the Target Position and the Current Position. For example, if the Current Position is 5000, and the Target Position is 7500, than the unit will output 2500 pulses. After the Absolute Move has been completed, the Current Position will be 7500. The direction of motion of an Absolute Move is determined by the relationship between the Current Position and Target Position. If the Target Position > Current Position, than CW motion will occur. If the Target Position < Current Position, than CCW motion will occur.

The current position does not have to be valid to perform a RELATIVE MOVE. The Target Position defines the distance, in number of pulses, to travel relative to the Current Position. For example, if the Current Position is 5000 and the Target Position is 7500, than the unit will output 7500 pulses. After the Relative Move has been completed, the Current Position will be 12,500. The direction of motion of a Relative Move is selected by the Most Significant Bit in the Most Significant Word of the Target Position. A "1" in the MSB will indicate a CCW move, while a "0" will indicate a CW move.

The ABSOLUTE or RELATIVE MOVE operations can produce two different velocity profiles. Normally the move operations start at the Starting Speed, accelerate to the Programmed speed at the defined acceleration rate, continue at the Programmed speed until it is time to decelerate back to the Starting Speed, and Stop. This generates a trapezoidal velocity profile.

However, if the move operation does not reach the Programmed speed by the time the deceleration is to begin, the move is decelerated to the Starting Speed and Stopped. In this way a triangular velocity profile is generated.

If the move operation runs to completion without error, the MOVE COMPLETE FLAG is set. If an error does occur, the MOVE COMPLETE FLAG will not be set, and an error flag will be set.

Hold Move

The HOLD MOVE command causes the move operation to decelerate to the Starting Speed and stop. When this operation is successfully performed, the Hold State Input Bit is set. While the Hold operation is in affect, the velocity and acceleration deceleration parameters can be changed, however, entering a new position will have no affect. If no error occurred during the stop operation, the RESUME MOVE command can be used to restart the move operation.

Note 1: If a Hold Move command is issued during a Blend Move operation, the stepper controller will stop. The Blend Move operation cannot be resumed.

Note 2: If a Hold Move command is issued during an Encoder Registration Move operation, the stepper controller will stop. The Encoder Registration Move operation cannot be resumed.

Note 3: The channel will go into a hold state even if the Hold Move command is issued during the deceleration portion of a move profile. If this occurs, issuing the Resume command will cause the Move Complete bit to come on.

Resume Move

The RESUME MOVE command resumes a previously held Absolute or Relative Move. If the Resume Move command is the first command issued after a Hold Move operation, and no errors have occurred, the Resume Move command will cause the stepper motor to restart from the point where it was stopped, and the Hold State Input Flag will go off. When the move operation has been successfully completed, the Move Complete Flag will be set. The velocity, acceleration, and deceleration parameters must be present when the Resume command is issued.

A move operation can be held and resumed many times until one of the following has occurred:

1. The move reaches its programmed target position
2. An error condition has occurred
3. Some other command is issued

Immediate Stop

The Immediate Stop command causes the current move operation to stop without any deceleration. That is, the step signal is simply stopped. If motion was occurring when this command was issued, the current position will become invalid, and the Position Invalid Input Bit will be set. The channel will have to be Preset or Homed again before an Absolute Move operation can be performed. However, it will be possible to perform a Relative Move or a Manual Move after an Immediate Interrupt has occurred.

Issuing an Immediate Stop command when there is no motion occurring will not cause the position to become invalid and will reset the Move Complete Status bit.

Find Home +/(CW), Find Home -/(CCW)

There are three homing options available. They are, homing to the home limit switch, homing to an encoder's marker pulse, or homing to both a home limit switch (acting as a proximity switch) and an encoder's marker pulse.

All three of the homing methods operate in the same way. The NX1F4X starts the homing operation at the programmed speed. When the home input is detected, the unit decelerates and stops. It then reverses direction and travels at the programmed speed until the Home Input turns on and off. It then reverses direction again and moves at the starting speed until the Home Input again turns on. The NX1F4X will then set the At Home input bit, and reset the current position and the encoder position to zero.

The Find Home commands require that at least one End Limit Switch, either CW or CCW, be present. The NX1F4X will not accept a Find Home +/(CW) command when there is no CW Limit Switch present. Likewise, it will not accept a Find Home -/(CCW) command when there is no CCW Limit Switch Present. If either of these operations are attempted, the COMMAND ERROR Input bit will be set.

If, during a Home operation, either of the End Limit Switch endpoints are reached, the motor will stop for two seconds, reverse direction, and start searching for the appropriate homing signal again. It is important not to have the velocity set to high during a homing operation. The sudden change in direction at high speeds may cause the motor to lock up.

The following diagrams illustrate the different homing options.

Home Limit Switch Only

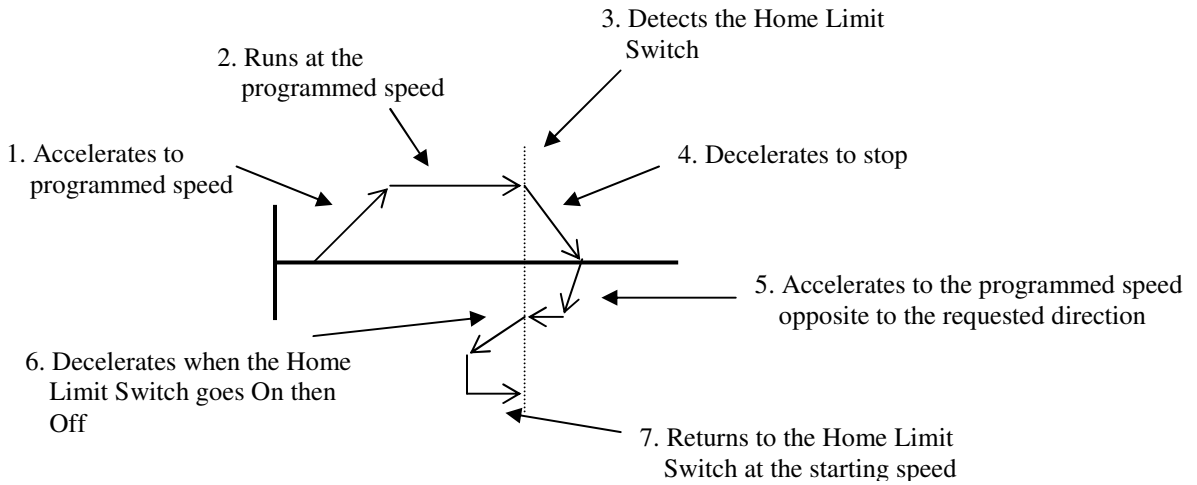

Home Limit Switch (treated as a Proximity Switch) and Marker Pulse

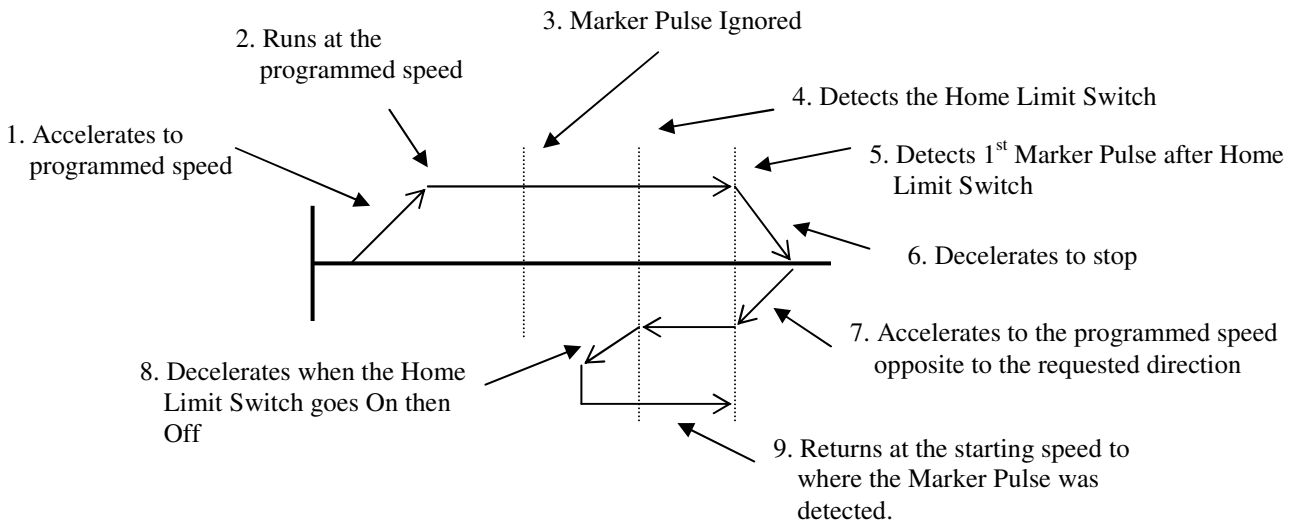

Marker Pulse Only

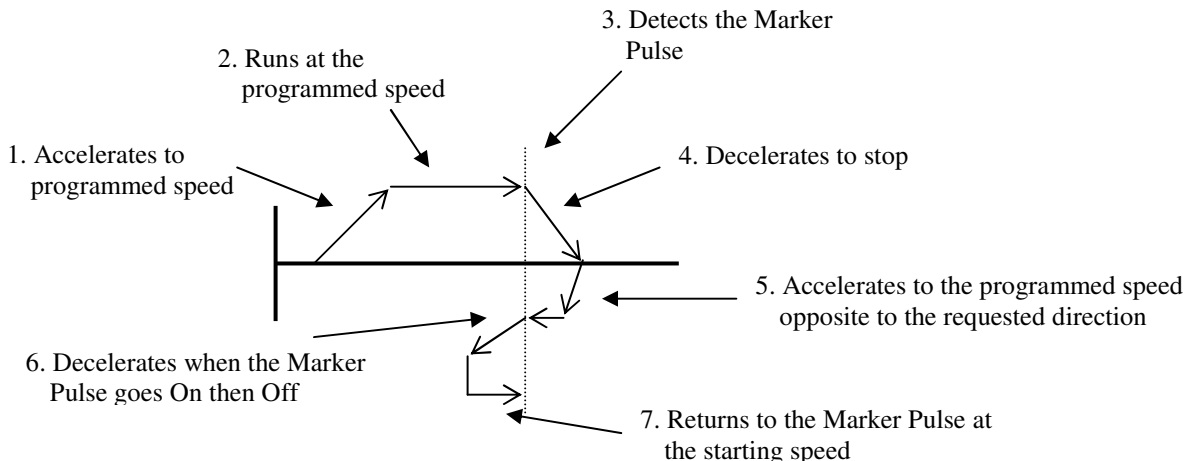

Reaching an End Limit Switch During a Homing Operation

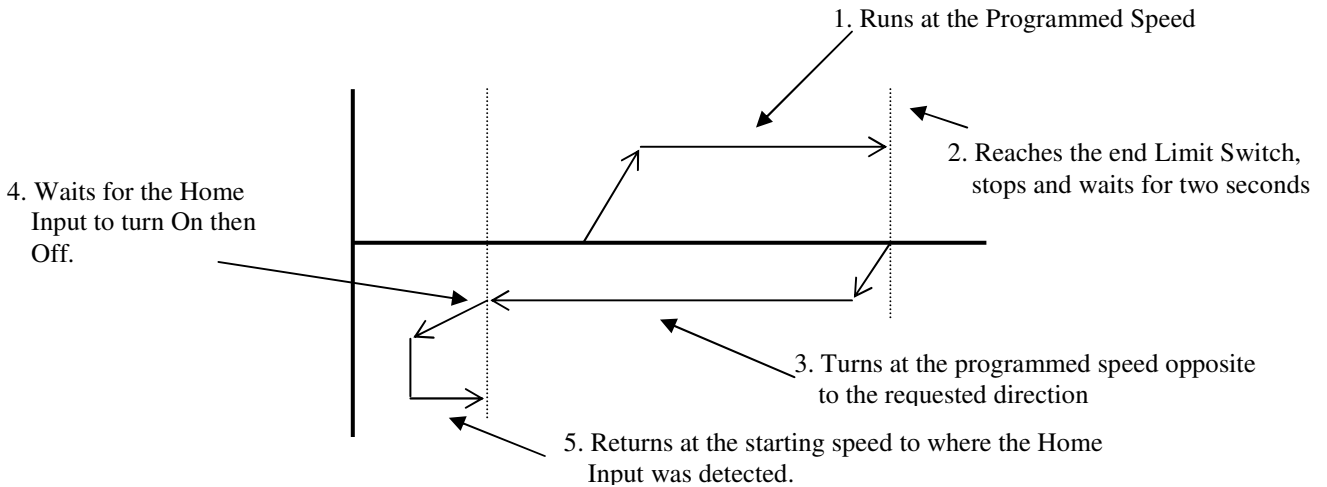

Note 1: The Home Input shown above can be either the Home Limit or the Marker Pulse.

Note 2: The above diagram will be true for all three of the homing methods, Home Limit only, Marker Pulse only, or Home Limit and Marker Pulse. In the case of the Home Limit and Marker Pulse, the NX1F4X will ignore any Marker Pulses until the Home Limit Switch is detected.

Home Limit Switch Active when the Home Command is issued

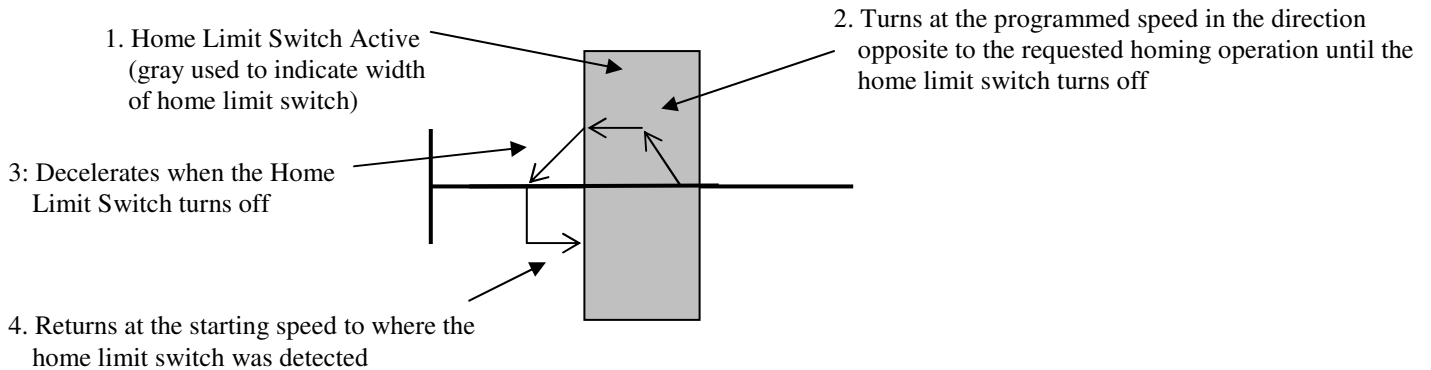

End Limit Switch Active when the Home Command is issued

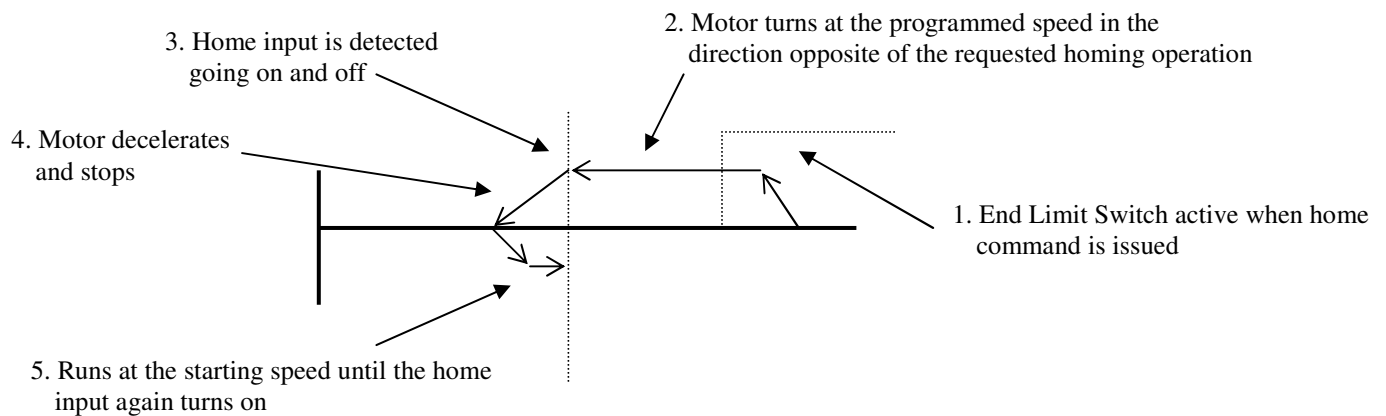

Note 1: The Home Input shown above can be either the Home Limit or the Marker Pulse.

Note 2: The above diagram is only true if the active End Limit Switch is the same as the issued home command, for example if the CW Limit Switch is active and a CW home command is issued. If the CW Limit Switch is active and a CCW home command is issued, than the unit will home normally, as if the end limit switch was not active.

Note 3: The above diagram will be true for all three of the homing methods, Home Limit only, Marker Pulse only, or Home Limit and Marker Pulse.

Manual Move +/(CW), Manual Move -(CCW)

This command performs the Manual Move operation at the programmed speed in the specified direction. Motion will occur as long as the command bit remains set. If the programmed speed is less than the starting speed, the starting speed is not used. The motor will run at the programmed speed, without any acceleration deceleration. If the programmed speed is greater than the starting speed, the axis begins the move at the starting speed, accelerates until the programmed speed is reached, and continues to move at the programmed speed until one of the following occurs:

- The Manual Move command bit is turned off
- The External Input, if it is configured to stop a manual move, is activated
- The Immediate Stop output bit is set
- The Emergency Stop Input is activated
- An End Limit Switch is reached
- The Programmed speed Changes

If the Manual Move command bit is turned off or if the External Input is active, the axis will decelerate to the starting speed and stop, retaining a valid position. If the Immediate Stop bit or the Emergency Stop Input is used, the axis will stop and the position will become invalid.

It is possible to change the speed of a Manual Move operation without stopping the motion. If the velocity data is changed while the axis is moving, the module will accelerate or decelerate to the new speed. The acceleration and or the deceleration parameters can also be changed, although these changes do not take affect until the programmed speed is changed. The acceleration parameter is checked only if the new speed is greater than the current speed. The deceleration parameter is checked only if the new speed is less than the current speed. The new speed can be less than the starting speed.

An additional feature of the Manual Move parameter is the ability to do a One Shot Manual Move. With the programmed speed set to zero, a 0 → 1 transition of the Manual Move bit will cause the stepper controller to output 1 pulse in the specified direction. Valid Acceleration and Deceleration data must be present when using the One Shot Manual Move function.

Manual Moves are allowed in the direction opposite to an active end limit switch. For example, a manual move CW will be allowed if the CCW End Limit Switch is active. A CCW Manual Move, even a One Shot Manual Move, will cause a Command Error.

Regardless of the direction of motion that is occurring, an end limit switch that transitions from Inactive to Active will cause a Manual Move to stop.

Preset Current Position

This command is used to set the current position at the specified value. The Desired Position value is copied into the Current Position Input Words. If the position is currently invalid, presetting the position will cause the position to become valid. The programmed speed, acceleration, and deceleration parameters must be zero when this command is sent to the module.

Reset Errors

This command clears all nonfatal errors detected by the stepper controller. A nonfatal error is one that can be recovered from. For example, requesting an Absolute Move when the position is not valid is a nonfatal error. When an error flag is ON, the controller will not perform any other operations until the Reset Errors command is issued.

Preset Encoder Position and Diagnostic Feedback Position

This command will set input words 4 and 5 for channel 1, input words 12 and 13 for channel 2, input words 20 and 21 for channel 3, or input words 28 and 29 for channel 4, to the value present in the Target Position registers. This is either the Encoder Position or the Diagnostic Feedback Position, depending on how the NX1F4X has been configured. The programmed speed, acceleration, and deceleration parameters must be zero when this command is sent to the module.

General Command Mode Operation Notes

1. Only one command bit can be set at any one time.
2. Only a 0 → 1 transition of any of the control bits listed above will cause the specified operation to take place.
3. A Command Error will be generated if a move operation is started before the previous move operation has completed. A move operation should only be started if the Move Complete, Stopped, or Hold status bits are set
4. If either the CW or CCW Limit Switches are reached during a normal move or manual move operation, the module will treat the input as an emergency stop, meaning that the motor will stop and the position will become invalid.
5. It is possible to home the NX1F4X off of an end limit switch.

Blend Move

This command allows the user to create more complicated move profiles consisting of two to sixteen segments, as the following diagram illustrates.

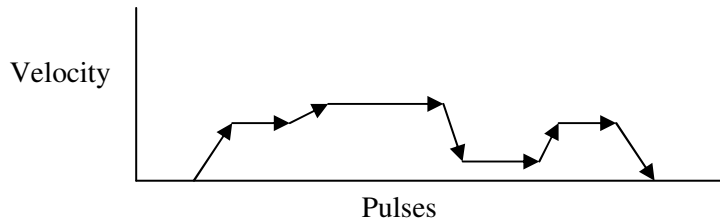

Each segment is defined by five parameters:

1. Absolute Target Position
2. Programmed speed
3. Acceleration Rate
4. Deceleration Rate
5. Acceleration Type (Linear, Triangular S Curve, or Trapezoidal S curve)

The minimum amount of information necessary to define a new move segment is a change in the Absolute Target Position and the Programmed speed. The Acceleration/Deceleration rates do not have to change during a Blend Move operation. If both a new Position and a new Programmed speed are not specified, the Command Error input bit will be set. A blend move profile cannot be setup as a series of encoder registration moves.

The blend move programming is done at one time, with the segments of the blend move profile stored in the internal memory of the NX1F4X. The Blend Move Profile is programmed as a series of Absolute Moves, meaning that the position has to be valid for the blend move operation to take place. The first segment starts at the Starting Speed and accelerates to the specified Programmed speed. The starting speed for the next segment is equal to the programmed speed of the current segment. The final segment will stop at the starting speed.

It is not possible to program a direction reversal in a blend move profile.

Because the NX1F4X stores the data for the Blend Move Profile in its memory, the programmed profile can be run more than once. The only restriction is that the blend move must always be started from the same valid position. If the Blend Move Profile is started from a different location, the stepper controller will set the Command Error Flag. Please note that it is possible to perform other move or home operations between performing the blend move profiles.

Blend Move Notes

1. A blend move will be stopped if an external input that has been configured to stop a manual move transitions from inactive to active.
2. A Command Error will be generated if you attempt to start a Blend Move with the External Input Latch Enable / Clear bit is set.

BLEND MOVE PROGRAMMING ROUTINE

The following is a description of how the Blend Move Profile will be programmed.

1. The PLC processor sets control bit 11, the PROGRAM BLEND MOVE PROFILE bit.
2. The NX1F4X responds by setting status bits 8 and 9, the BLEND MOVE MODE BIT and the SEND NEXT BLEND MOVE DATA BIT.
3. When the PLC processor detects that the Send Next Blend Move Data bit is set, it writes the first segments data and sets control bit 12, the READ BLEND DATA BIT.
4. The NX1F4X checks the data, and when finished, resets the Send Next Blend Move Data bit. If an error is detected, it also sets the Command Error bit 12, and the Error LED.
5. When the PLC processor detects that the Send Next Blend Move Data bit is reset, it resets the Read Blend Data bit
6. The NX1F4X detects that the Read Blend Data bit is reset, and sets the Send Next Blend Move Data bit.
7. Steps 3 to 6 are repeated for the remaining segments until the entire blend move profile has been entered. The maximum number of segments per profile is 16.
8. After the last segment has been transferred, the PLC processor exits Blend Move Mode by resetting control bit 11, the Program Blend Move Profile bit.
9. The NX1F4X resets the Blend Move Mode bit and the Send Next Blend Move Data bit.
10. When the blend profile is to be performed, the PLC processor sets control bit 13, the RUN BLEND MOVE PROFILE bit. Please note that the profile cannot be run until the NX1F4X has reset the Blend Move Mode bit.
11. The NX1F4X sets status bit 8, the Blend Move Mode Bit and performs the programmed profile.
12. When the profile has run to completion, the NX1F4X sets status bit 7, the MOVE COMPLETE BIT, and resets the Blend Move Mode Bit.
13. Steps 10 to 12 can be repeated as long as the profile is started from the same position every time it is run.

Encoder Registration Move

The encoder position acts as a registration mark in an Encoder Registration Move. Typically, the encoder is mounted separately from the motor. With this mode, the NX1F4X will drive the motor until the desired encoder count is reached, at which time the motor begins to decelerate and stop. This functionality is useful in spool winding or unwinding applications, where the motor drives the spool and the encoder measures the material length as it enters or exits the spool. As the spool diameter increases or decreases, the programmed distance remains the same because you are measuring material, not the number of turns.

The following must be considered when using the Encoder Registration Move function.

- An Encoder Registration move will overshoot the programmed target position.
- After motion has stopped, the NX1F4X module will set status bit 7, the Move Complete bit.
- The NX1F4X module uses X4 decoding on the encoder inputs, so the number of counts per turn of the encoder will be four times the encoder's resolution. For example, if a 1000 line encoder is being used, the NX1F4X will report 4000 counts per turn. This is the number that must be used when determining the position data of your encoder registration move.
- It is possible to perform a negative encoder registration move, motion in the Counter Clockwise direction, by setting bit 15 of the Most Significant word of the position data.
- If the NX1F4X module is not configured to accept encoder inputs, attempting an encoder registration move will cause a command error to be generated.
- It is not possible to hold an encoder registration move. Motion will stop if the backplane hold command is issued during an encoder registration move. No Error will generated

Activating an External Input that has been configured to stop a Manual Move will cause motion to stop. No error will be generated.

Activating an External Input that has been configured to capture encoder data will not affect an encoder registration move.

- Setting bit 2 of the second control word during a manual move or home operation will not have any affect on the NX1F4X module's profile.
- Before performing a standard absolute or relative move, it is necessary to reset bit 2 of the second control word.

Master-Slave Mode

This feature is only available with the Version 2.0 and higher firmware, starting with serial number 88742.

In this mode, channel 1 will act as the master and channels 2 through 4 may be selected to be slaves. That is, the slave channel will only output steps when the master channel is running. Also, through the use of multiplier and divisor values, it will be possible to have the slave channel output steps at a faster or slower rate than the master channel, as the following diagram illustrates.

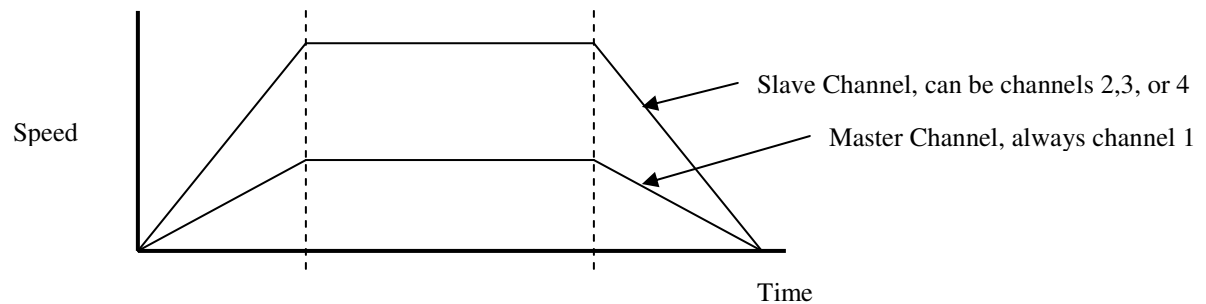

While being the Master, Channel 1 can run any type of move profile.

Control Word 2 bit 6 is used to place channels 2, 3, or 4 in slave mode. The NX1F4X will set Status Word 2, bit 6 to indicate that the channel is operating in slave mode.

The slave channel uses the Manual Move command to initiate the slave move and also to select the direction of travel. If the Manual Move + (CW) command is used, than the slave channel will move in the same direction as the master. If the Manual Move – (CCW) command is used, than the slave channel will move in the opposite direction from the master. An External Input configured to stop a Manual Move will also stop motion on a slave channel.

The slave Multiplier and Divisor values have a range of 1 to 32767 and can be changed on the fly.

The Programmed Speed parameter of the slave channel must be zero or the NXIF4X will generate a Command Error.

The slave channel can also use the Acceleration and Deceleration parameters. If these parameters are zero, the slave channel will jump from its current speed to its new speed without acceleration, which may stall the motor. If these parameters are not zero, than the channel will use the acceleration and deceleration parameters to reach the required speed.

The status bits of a channel that is operating as a slave will show the direction of motion (status word 1 bits 0 or 1) but will not show if the channel is accelerating or decelerating (status word 1, bits 5 or 6).

While in Master/Slave mode, the following conditions will set the *Command Error bit* (Status Word 1, bit 12).

- An Immediate Stop on the master channel will cause a fault on the slave channel.
- Attempting to place channel 1 in Slave Mode by setting Control Word 2, bit 6
- Trying to place a channel that is not stopped in Slave mode
- If the multiplier or divisor values are outside of the range of 1 to 32767. Also Invalid Manual Move
- If the Programmed Speed registers are not zero. Also Invalid Manual Move Error
- If the direction of the slave channel Manual Move command bit is changed without at least one scan where the command word is zero.

Encoder Follower

This feature is only available with the Version 2.0 and higher firmware, starting with serial number 88742.

In Encoder Follower mode, the channel will output a step only when an input pulse is received on the encoder inputs. Any of the channels can be programmed to act as an Encoder Follower. Also, through the use of multiplier and divisor values, it will be possible to have the channel output steps faster or slower than the rate of the encoder pulses.

Control Word 2 bit 7 is used to place the channel in Encoder Follower mode. The NX1F4X will set Status Word 2, bit 7 to indicate that the channel is operating as an Encoder Follower.

The Encoder Follower channel uses the Manual Move command to select the direction of travel. If the Manual Move + (CW) command is used, than the Encoder Follower channel will move in the same direction as the encoder. If the Manual Move – (CCW) command is used, than the Encoder Follower channel will move in the opposite direction from the encoder. An External Input configured to stop a Manual Move will also stop Encoder Follower motion.

The Encoder Follower Multiplier and Divisor values have a range of 1 to 32767 and can be changed on the fly.

As with all of the NX1F4X's encoder functions, X4 decoding is used to decode the encoder's position. This decoding type must be taken into account when calculating the appropriate multiplier and divisor values.

The Programmed Speed parameter of the Encoder Follower channel must be zero or the NXIF4X will generate a Command Error.

The Encoder Follower channel can also use the Acceleration and Deceleration parameters. If these parameters are zero, the motion will jump from its current speed to its new speed without any acceleration, which may stall the motor. If these parameters are not zero, than the channel will use the acceleration and deceleration parameters to reach the required speed.

While in Encoder Follower mode, the following will set the *Command Error bit* (Status Word 1, bit 12).

- Placing a channel that has not been configured to use an encoder in Encoder Follower mode
- Trying to place a channel that is not stopped in Encoder Follower mode
- If the multiplier or divisor values are outside of the range of 1 to 32767. The Invalid Manual Move error bit will also be set.
- If the Programmed Speed registers are not zero. The Invalid Manual Move error bit will also be set.
- If the direction of the Encoder Follower channel Manual Move command bit is changed without at least one scan where the command word is zero.

Registration Move

This feature is only available with the Version 2.0 and higher firmware, starting with serial number 88742.

The Registration Move function modifies the Manual Move operation.

If the target position registers are zero, the Manual Move will occur exactly as described on pages 23 and 24 of these specifications.

If the target position registers are not zero, the number of steps entered will be output at the end of the Manual Move. As shown in the following diagram, this number of steps also includes the time to decelerate and stop.

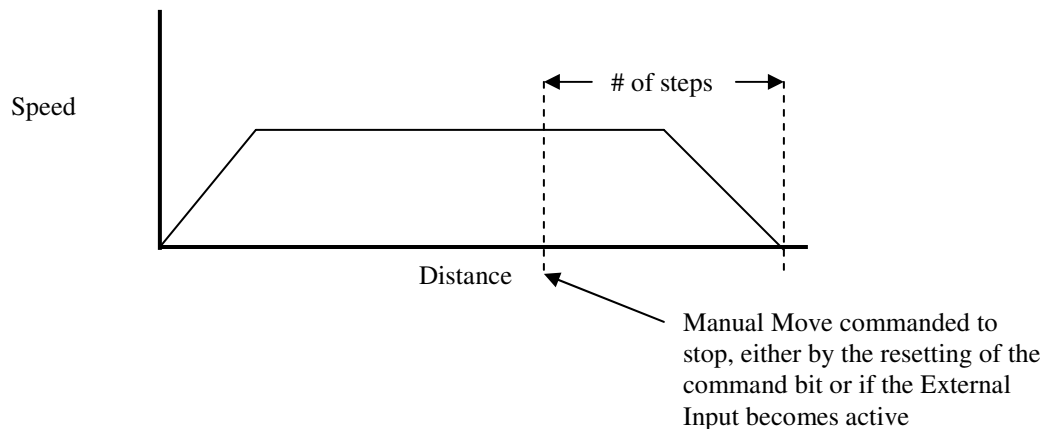

Note: An external Input configured to capture encoder data will not stop a Registration Move.

When performing a Registration Move, the following conditions will set the *Command Error bit* (Status Word 1, bit 12).

- If the Registration Move is started with the External Input active.

When performing a Registration Move, the following conditions will set both the *Command Error bit* (Status Word 1, bit 12) and the *Invalid Manual Move bit* (Status Word 2, bit 9).

- If the number of steps programmed into the target position registers is less than the number of steps required to accelerate and decelerate and stop the motion. In this case the Registration Move will not start.
- If the Registration Move speed is changed while motion is occurring. (It is allowed to change the speed of a Manual Move, with the target position registers equal to zero, while motion is occurring.)
- If the number of steps programmed into the target position registers is negative.
- If the value of the target position registers is changed after a Registration Move has been initiated.
- If a value is entered in the target position registers while a Manual Move is occurring.

Errors that occur after either a Manual Move or a Registration Move have been started will not stop the motion. In these cases, the NX1F4X will set the error bits, ignore the new data, and continue the original move operation until either the command bit is reset or the External Input becomes active.

Acceleration Types

All of the move operations defined above allow the type of acceleration to be selected. The three options are described below.

Constant Acceleration: The module accelerates at a constant rate until the programmed speed is reached.

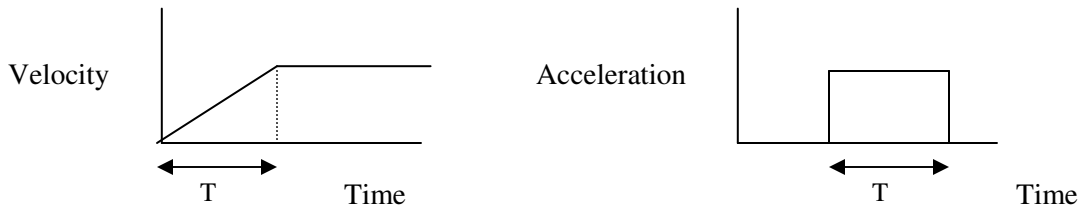

Triangular S Curve Acceleration: The module accelerates slowly at the beginning of the acceleration, faster at the middle of the acceleration, and again slowly at the end of the acceleration. The acceleration rate is never constant.

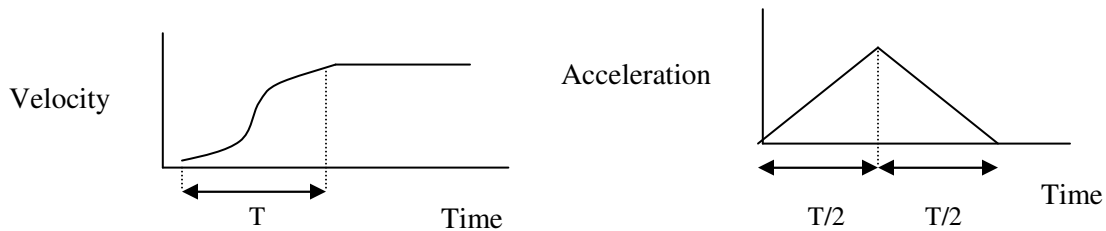

Trapezoidal S Curve Acceleration: The module accelerates slowly at the beginning of the acceleration, at a constant rate at the middle of the acceleration, and again slowly at the end of the acceleration.

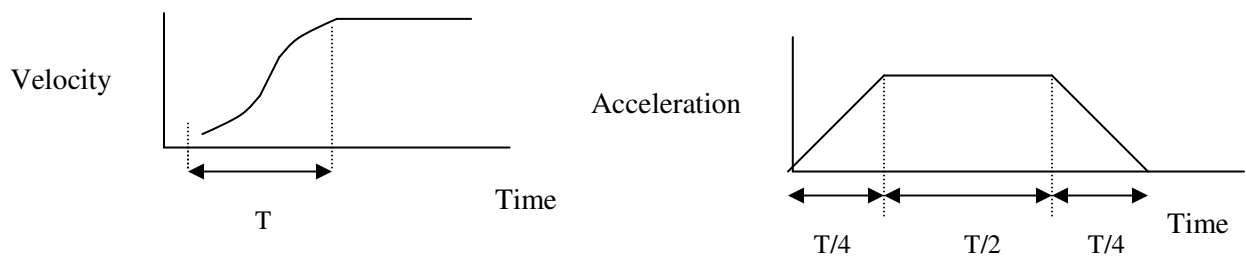

Notes:

1. The defined acceleration type is also applied to the deceleration.
2. Constant acceleration has the shortest acceleration time and Triangular S Curve has the longest acceleration time.

Chapter 5: Command Mode Output Data

All stepper motor operations are performed in command mode. This mode is entered, after a successful configuration file has been transferred to the stepper controller, by resetting the Mode Flag bit 15.

In Command Mode, the PLC program can issue commands and activate different operations or moves. A move profile typically consists of a Target Position, Programmed Speed, Acceleration and Deceleration parameters. The following table shows the function of the output words.

Output Data when NX1F4X is being used to perform Standard Move Operations

Word	Channel	Standard Function	Units	Range
0	1	Control 1		See Description below
1	1	Control 2		See Description below
2	1	Target Position MSW	Steps	-8,388,607 to 8,388,607
3	1	Target Position LSW		
4	1	Programmed Speed MSW	Steps / Second	Starting Speed to 250,000
5	1	Programmed Speed LSW		
6	1	Acceleration	Steps/ms/sec	1 to 2000
7	1	Deceleration	Steps/ms/sec	1 to 2000
8	2	Control 1		See Description below
9	2	Control 2		See Description below
10	2	Target Position MSW	Steps	-8,388,607 to 8,388,607
11	2	Target Position LSW		
12	2	Programmed Speed MSW	Steps / Second	Starting Speed to 250,000
13	2	Programmed Speed LSW		
14	2	Acceleration	Steps/ms/sec	1 to 2000
15	2	Deceleration	Steps/ms/sec	1 to 2000
16	3	Control 1		See Description below
17	3	Control 2		See Description below
18	3	Target Position MSW	Steps	-8,388,607 to 8,388,607
19	3	Target Position LSW		
20	3	Programmed Speed MSW	Steps / Second	Starting Speed to 250,000
21	3	Programmed Speed LSW		
22	3	Acceleration	Steps/ms/sec	1 to 2000
23	3	Deceleration	Steps/ms/sec	1 to 2000
24	4	Control 1		See Description below
25	4	Control 2		See Description below
26	4	Target Position MSW	Steps	-8,388,607 to 8,388,607
27	4	Target Position LSW		
28	4	Programmed Speed MSW	Steps / Second	Starting Speed to 250,000
29	4	Programmed Speed LSW		
30	4	Acceleration	Steps/ms/sec	1 to 2000
31	4	Deceleration	Steps/ms/sec	1 to 2000

Output Data when NX1F4X is being used to perform Slave or Encoder Follower Operations

Word	Channel	Slave Mode	Encoder Follower	Units	Range
0	1	N/A	Control 1		See Description below
1	1	N/A	Control 2		See Description below
2	1	N/A	Multiplier		1 to 32767
3	1	N/A	Divisor		1 to 32767
4	1	N/A	Must be zero		0
5	1	N/A	Must be zero		0
6	1	N/A	Acceleration	Steps/ms/sec	0 to 2000
7	1	N/A	Deceleration	Steps/ms/sec	0 to 2000
8	2	Control 1	Control 1		See Description below
9	2	Control 2	Control 2		See Description below
10	2	Multiplier	Multiplier		1 to 32767
11	2	Divisor	Divisor		1 to 32767
12	2	Must be zero	Must be zero		0
13	2	Must be zero	Must be zero		0
14	2	Acceleration	Acceleration	Steps/ms/sec	0 to 2000
15	2	Deceleration	Deceleration	Steps/ms/sec	0 to 2000
16	3	Control 1	Control 1		See Description below
17	3	Control 2	Control 2		See Description below
18	3	Multiplier	Multiplier		1 to 32767
19	3	Divisor	Divisor		1 to 32767
20	3	Must be zero	Must be zero		0
21	3	Must be zero	Must be zero		0
22	3	Acceleration	Acceleration	Steps/ms/sec	0 to 2000
23	3	Deceleration	Deceleration	Steps/ms/sec	0 to 2000
24	4	Control 1	Control 1		See Description below
25	4	Control 2	Control 2		See Description below
26	4	Multiplier	Multiplier		1 to 32767
27	4	Divisor	Divisor		1 to 32767
28	4	Must be zero	Must be zero		0
29	4	Must be zero	Must be zero		0
30	4	Acceleration	Acceleration	Steps/ms/sec	0 to 2000
31	4	Deceleration	Deceleration	Steps/ms/sec	0 to 2000

Command Mode Programming Notes

1. The data format of the Output Words is decimal.
2. Thirty-two bit values are divided into two words. The Most Significant Words contain the 1000s places, the upper 4 decimal digits, of the Position and Programmed Speed data. The Least Significant Words contains the 1s, 10s, and 100s places, the lower 3 decimal digits, of the Position and Programmed Speed data
3. A negative position value will be programmed by setting bit 15 in Output Word 2 for channel 1, bit 15 in Output Word 10 for channel 2, bit 18 in Output Word 18 for channel 3, or bit 15 in Output Word 26 for channel 4.
4. The Position parameter has a range of $-8,388,607 \leq \text{Target Position} \leq 8,388,607$.
5. The Programmed Speed has a range of $\text{Starting Speed} \leq \text{Programmed Speed} \leq 250,000$.
6. The acceleration and deceleration parameters have a range of $1 \leq \text{acceleration/deceleration} \leq 2000$ and is measured in pulses/ms/sec.
7. In both Slave mode and Encoder Follower mode, the multiplier and divisor parameters have ranges of 1 to 32,767.

Channel 1 Word 0, Channel 2 Word 8, Channel 3 Word 16, and Channel 4 Word 24:

- bit 0 = set when performing an ABSOLUTE MOVE operation *
- bit 1 = set when performing a RELATIVE MOVE operation *
- bit 2 = set when performing a HOLD MOVE operation
- bit 3 = set when performing a RESUME MOVE operation *
- bit 4 = set when performing an IMMEDIATE STOP operation
- bit 5 = set when performing a FIND HOME +/(CW) operation *
- bit 6 = set when performing a FIND HOME -/(CCW) operation *
- bit 7 = set when performing a MANUAL MOVE +/(CW) operation
- bit 8 = set when performing a MANUAL MOVE -/(CCW) operation
- bit 9 = set when performing a PRESET POSITION operation *
- bit 10 = set when performing a RESET ERRORS operation
- bit 11 = set to PROGRAM BLEND MOVE PROFILE *
- bit 12 = set when the stepper controller is to READ BLEND DATA *
- bit 13 = set to RUN BLEND MOVE PROFILE *
- bit 14 = set to PRESET optical encoder or diagnostic feedback data *
- bit 15 = MODE FLAG: "1" for Configuration Mode *
"0" for Command Mode

Note: The channel must be stopped before any of the commands with the * can be initiated.

Channel 1 Word 1, Channel 2 Word 9, Channel 3 Word 17, and Channel 4 Word 25:

- bit 0: “1” for S curve acceleration, “0” for constant acceleration
- bit 1: If bit 0 is a “1”, resetting bit 1 to “0” will indicate a triangular acceleration profile. If bit 0 is a “1”, setting bit 1 to “1” will indicate a trapezoidal acceleration profile. If bit 0 is “0”, bit 1 must be zero.
- bit 2: Encoder Registration Move Setting this bit during an absolute or relative move will cause the move distance to be based on the encoder input, not on the pulses output to the stepper driver.
- bits 3 to 5: reserved for future use
- bit 6: Set to place Channels 2, 3, or 4 in slave mode. Setting this bit on channel 1 will cause a Command Error.
- bit 7: Set to place the channel in Encoder Follower mode.
- bits 8 to 10: reserved for future use
- bit 11: External Input Latch Enable/Clear. . Set this bit to enable the External Input Latching function. Reset this bit to disable the Latching Function. **This functionality is only available on NX1F4X-06 units**

When this bit is set, the External Input Latch Status bit, which is located in Status word 2, will be set when the External Input becomes active. This status bit will remain set, even if the External Input becomes inactive, and will be reset when the External Input Latch Enable/Clear bit is reset. The following diagram illustrates this functionality.

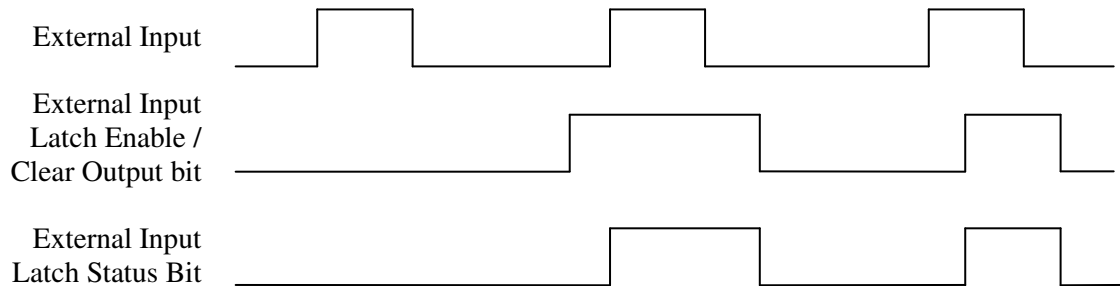

bits 12 to 15: reserved for future use

Chapter 6: Command Mode Input Data

When the NX1F4X module is in command mode, its status information is reported to the PLC in the Input Registers. This data has the following format:

Note: A ControlLogix system using ControlNet will require 34 input words. The first two words will always be zero, and the channel 1 Status Word 1 will be located in input word 2.

Input Word	Channel	Status Information
0	1	Status Word 1
1	1	Status Word 2
2	1	Most Significant Word Current Position
3	1	Least Significant Word Current Position
4	1	Most Significant Word Encoder or Diagnostic Feedback Position
5	1	Least Significant Word Encoder or Diagnostic Feedback Position
6	1	Most Significant Word Captured Encoder Position
7	1	Least Significant Word Captured Encoder Position
8	2	Status Word 1
9	2	Status Word 2
10	2	Most Significant Word Current Position
11	2	Least Significant Word Current Position
12	2	Most Significant Word Encoder or Diagnostic Feedback Position
13	2	Least Significant Word Encoder or Diagnostic Feedback Position
14	2	Most Significant Word Captured Encoder Position
15	2	Least Significant Word Captured Encoder Position
16	3	Status Word 1
17	3	Status Word 2
18	3	Most Significant Word Current Position
19	3	Least Significant Word Current Position
20	3	Most Significant Word Encoder or Diagnostic Feedback Position
21	3	Least Significant Word Encoder or Diagnostic Feedback Position
22	3	Most Significant Word Captured Encoder Position
23	3	Least Significant Word Captured Encoder Position
24	4	Status Word 1
25	4	Status Word 2
26	4	Most Significant Word Current Position
27	4	Least Significant Word Current Position
28	4	Most Significant Word Encoder or Diagnostic Feedback Position
29	4	Least Significant Word Encoder or Diagnostic Feedback Position
30	4	Most Significant Word Captured Encoder Position
31	4	Least Significant Word Captured Encoder Position

Status Word 1

- bit 0 = set when the axis is moving CW
- bit 1 = set when the axis is moving CCW
- bit 2 = set when the stepper controller is in a HOLD STATE
- bit 3 = set when the axis is STOPPED, must be set before a move operation can begin (This bit will not be set when the channel is operating in Slave mode)
- bit 4 = set when the axis is AT HOME
- bit 5 = set when the axis is ACCELERATING
- bit 6 = set when the axis is DECELERATING
- bit 7 = set when MOVE COMPLETE (can be reset by issuing an Immediate Stop command when motion is not occurring, or by using the Preset Position command.)
- bit 8 = set when the stepper controller is in BLEND MOVE MODE
- bit 9 = set when module is ready to receive the next Blend Move Segment
- bit 10 = set when POSITION INVALID
- bit 11 = set when there is an INPUT ERROR
- bit 12 = set when there is a COMMAND ERROR, must be reset before another command will be accepted
- bit 13 = set when there is a CONFIGURATION ERROR
- bit 14 = set when MODULE OK
- bit 15 = MODE FLAG "1" configuration mode, "0" for command mode

Status Word 2

- bit 0 = set when the CCW LIMIT SWITCH input is active
- bit 1 = set when the CW LIMIT SWITCH input is active
- bit 2 = reserved
- bit 3 = set when the EXTERNAL INPUT is active
- bit 4 = set when the HOME LIMIT SWITCH input is active
- bit 5 = set when the stepper controller EMERGENCY STOP input is active
- bit 6 = set when channels 2, 3, or 4 are operating in Slave mode
- bit 7 = set when the channel is in Encoder Follower mode
- bit 8 = HOME INVALID bit.
- bit 9 = INVALID MANUAL MOVE bit. This bit will remain set until the Reset Error command has been issued. Motion will continue until the command bit is reset or the external input becomes active.
- bit 10 = set when there is an INVALID PROFILE error
- bit 11 = EXTERNAL INPUT LATCH STATUS BIT. This bit will be set when the External Input is active and the External Input Latch Enable / Clear bit is set. This status bit will remain set, even if the External Input becomes inactive, until the External Input Latch Enable/Clear bit is reset.
- bits 12→15 = reserved for future use

CURRENT POSITION

These two input words report the Current Position based on the number of pulses that have been output to the stepper driver. This value may be different from the Encoder Position. If the Most Significant bit of the Most Significant word is set, then the Current Position data is negative. Range = 0 to 8,388,607 to -8,388,608 to 0.

ENCODER POSITION

These two input words report the position based on the feedback from an encoder attached to the stepper motor. This value may be different from the Current Position. If the Most Significant bit of the Most Significant word is set, then the Encoder Position data is negative. Range = 0 to 8,388,607 to -8,388,608 to 0.

CAPTURED ENCODER POSITION

These two input words report the encoder value that was present when the external input transitions from “0” to “1”. This will only occur if the module has been configured to have the external input trap the encoder data. If the Most Significant bit of the Most Significant word is set, then the Captured Encoder Position data is negative. The Captured Encoder Position cannot be reset from the PLC and will not be cleared by a homing operation. If the external input is configured to stop a manual move operation, these two words will be zero.

The Move Complete Bit has the following function

The Move Complete Bit will be set after Absolute Moves, Relative Moves, Home Operations, or Blend Moves have been completed. The Move Complete bit will not be set after a Hold Operation, Manual Moves, or Registration Moves.

The Move Complete Bit will be reset at the beginning of the next move, by a Preset Position Operation, or by issuing an Immediate Stop Command when motion is not occurring.

The Position Invalid will be set under the following conditions

1. After a configuration operation has occurred. This will be true even if the position was valid before the configuration operation took place.
2. After an Immediate Stop command has been issued.
3. If the Emergency Stop input has been activated.
4. If either of the End Limit Switches becomes active during any move operation except for homing.

The Input Error bit will be set under the following conditions

1. If the Emergency Stop input has been activated
2. If either of the End Limit Switches become active. This is also true of a homing operation where the motor reverses direction after encountering the End Limit Switch.

A Command Error will be generated under the following conditions

Note: If a move operation is occurring when a Command Error condition is detected, the error bit will be set immediately and the move will run to completion.

1. If the network connection is lost.
2. Configuring the module when a move operation is occurring.
3. If more than one Command bit is set.
4. If any of the unused bits in Control Word 2 are set.
5. If the Target Position, Programmed Speed, Acceleration, or Deceleration parameters are outside of their valid ranges. This is also true of the parameters in a blend move segment.

-
6. If the programmed speed is less than the starting speed. This applies to Absolute Moves, Relative Moves, Homing operations, and Blend Moves. However, Manual Moves can be run at speeds less than the starting speed.
 7. Performing an Absolute Move when the Current Position is not valid.
 8. Issuing a Resume Command when there is no Absolute or Relative move in progress.
 9. Selecting a trapezoidal acceleration profile without first selecting S curve acceleration.
 10. A Preset Position Command, including Encoder Position Preset, that has data in the registers that contain the Programmed Speed, Acceleration, or Deceleration parameters.
 11. Issuing a Homing command with the Target Position registers not equal to zero.
 12. Issuing a Homing Command in a direction that does not have an End Limit Switch configured.
 13. If a value is entered in the target position registers while a Manual Move is occurring.
 14. Performing a Manual Move in the same direction as the active End Limit Switch.
 15. Changing the speed of a Manual Move on the fly to an invalid value.
 16. If the Encoder Registration Move bit is set when a Manual Move is being performed.
 17. Any Encoder operation, such as encoder registration move, encoder preset, or encoder follower, when the module has not been configured to use an encoder.
 18. If a Blend Move segment does not reach the Programmed Speed.
 19. Trying to run a Blend Move profile from a position different from the one that it was programmed for.
 20. Programming a Blend Move segment without changing both the Target Position and the Programmed Speed.
 21. Programming a Blend Move profile that includes a direction reversal.
 22. Programming more than sixteen Blend Move Segments.
 23. Programming an Encoder Registration Move in a Blend Move Profile.
 24. Running a Blend Move profile without first programming the Blend Move Segments.
 25. If the network connection is removed and then restored.
 26. Attempting to place channel 1 in Slave Mode by setting Control Word 2, bit 6.
 27. Trying to place a channel that is not stopped in Slave mode.
 28. If the Slave Mode multiplier or divisor values are outside of the range of 1 to 32767.
 29. If the Slave Mode Programmed Speed registers are not zero.
 30. If the direction of the Slave channel Manual Move command bit is changed without at least one scan where the command word is zero.
 31. Attempting to place a channel that has not been configured to use an encoder in Encoder Follower mode.
 32. Trying to place a channel that is not stopped in Encoder Follower mode.
 33. If the Encoder Follower Mode multiplier or divisor values are outside of the range of 1 to 32767.
 34. If the Encoder Follower Mode Programmed Speed registers are not zero.
 35. If the direction of the Encoder Follower channel Manual Move command bit is changed without at least one scan where the command word is zero.
 36. If the number of steps programmed into the target position registers during a Registration Move is less than the number of steps required to decelerate and stop the motion.
 37. If the number of steps programmed into the target position registers during a Registration Move is negative.
 38. If the Registration Move is started with the External Input active.
 39. If the Registration Move speed is changed while motion is occurring.
 40. If the value of the target position registers is changed after a Registration Move has been initiated.
 41. Having the External Input Latch Enable / Clear bit set when issuing a Preset Position, Preset Encoder, Program Blend Move, or Run Blend Move command.

The Configuration Error bit will be set under the following conditions

1. At power up, before the NX1F4X has been configured.
2. If an invalid configuration has been sent to the module.

The Module OK Flag

This bit will be set as long as the module is operating. Only a fatal error will cause this bit to be reset to zero.

The Home Invalid bit will be set under the following conditions

1. Issuing a Home command with the Target Position registers not equal to zero.
2. Issuing a Home command if the Programmed Speed is less than the starting speed.
3. Issuing a Home Command in a direction that does not have an End Limit Switch configured.
4. If both End Limit Switches are reached during a homing operation. This error will only occur if the motor reverses direction after encountering the first End Limit switch.
5. If the opposite End Limit Switch is reached during a homing operation. For example, if the CCW Limit Switch is first reached during a CW homing operation. Improper wiring or placement of the limit switch would most likely cause this error.
6. If the module has been configured for Marker Pulse only home and the End Limit Switch is active when the first marker pulse is detected.

The Invalid Manual Move bit will be set under the following conditions.

1. If a Manual Move is initiated with any invalid parameters.
2. If the multiplier or divisor values used in Slave Mode or Encoder Follower Mode are outside of the range of 1 to 32,767.
3. If the velocity value is not zero in Slave Mode or Encoder Follower Mode.
4. If the speed of the Manual Move is changed to an invalid value while motion is occurring.
5. If the number of steps programmed into the target position registers during a Registration Move is less than the number of steps required to decelerate and stop the motion.
6. If the value of the target position registers is changed after a Registration Move has been initiated.
7. If a value is entered in the target position registers while a Manual Move is occurring.
8. If the number of steps programmed into the target position registers during a Registration Move is negative.
9. If the Registration Move is started with the External Input active.
10. If the Registration Move speed is changed while motion is occurring.
11. If the Encoder Registration Move bit is set when a Manual Move is being performed.

The Invalid Profile bit will be set under the following conditions

1. If the Programmed Speed is less than the starting speed.
2. If any of the move parameters are outside of their valid ranges.
3. If the parameters defining a blend move profile segment are invalid. That is, if the distance that it takes to accelerate to the programmed speed exceeds the length of the segment.
4. If any of the unused bits in Control Word 2 are set.
5. Setting the Trapezoidal Profile bit (second command word bit 1) without setting the S curve bit (second command word bit 0).

Chapter 7: Network Connections

NX1F4C (ControlNet) Hardware Overview

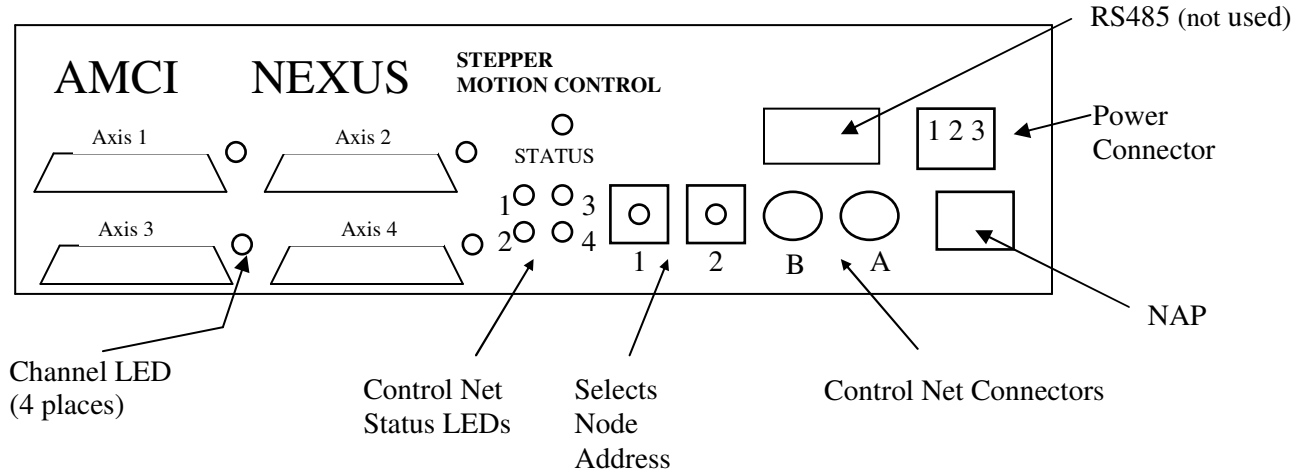

Node Address Selection

The NX1F4C has two rotary switches used to set the module's address on the network. Any node from 0 to 99 can be selected. Switch 1 sets the one digit and switch 2 sets the 10s digit of the address. For example, if the NX1F4C is to be installed at node 46, switch 1 would be set to 6, and switch 2 would be set to 4. Note, changing the node address only takes affect at power up. Changing the address while power is applied to the NX1F4C will generate a minor fault.

ControlNet Status LEDs

The following table describes the function of the four network status LEDs.

LED Number	Name	LED Pattern	Function
1	Channel B status	Solid Green Flashing Red/Off Solid Off	Channel Operating Correctly Channel Disconnected from Network Channel Disabled
2	Channel A status	Solid Green Flashing Red/Off Solid Off	Channel Operating Correctly Channel Disconnected from Network Channel Disabled
3	Module Owned	Solid Green Off Solid Red	Network Card is communicating with Nexus Network Card is not communicating with Nexus Incorrectly Configured Network. Possible causes are incorrect Node #, Number of I/O words, or Comm format.
4	Module Status	Flashing Green Solid Green Flashing Red Solid Red	Network Card is waiting for initialization Module is initialized and operating correctly Minor Fault (For example Node address changed) Major Fault, module must be restarted

Network Update Time

The NX1F4C has a minimum network update time of 5ms.

Quick Start Guide**AMCI Nexus to ControlLogix**

1. With the power off, use the rotary switches on the Nexus to select the desired node address.
2. Connect the Nexus to the ControlNet using a ControlNet Tap to coax media. Either the A or B port can be used, depending on how your network is configured.
3. Apply power to the Nexus unit.
4. Start RSLogix 5000.
5. Start RSLinx and establish communications to the ControlLogix system.
6. Configure the ControlLogix hardware system, processor and discrete I/O. If it is not already present, also add the ControlNet adapter 1756-CNB(R) module to the system.
7. Right-click on the 1756-CNB(R) module and Click on **New Module...**
8. Define the NX1F4C as a generic CONTROLNET-MODULE. Click on **OK** and define the properties as follows.

Name:	<i>Your Choice</i>
Description:	<i>Your Choice</i>
Comm Format:	Data-INT (must be set to Data-INT)
Node:	Set it to the same value as the Node address on the NX1F4C

Assembly Instance – 100, **Input** – 34
Assembly Instance – 150, **Output** – 32
Assembly Instance – 110, **Config** – 0

9. Click on **Next>**
10. Define the RPI. The minimum value is 5.0ms, however the value may be set higher.
11. Click **Finish**.
12. Save and Download the file to the Processor
13. Start RSNetworx for ControlNet and either open an existing project or create a new one.
14. If this is the first time using the NX1F4C, register the appropriate EDS file and icon from AMCI's website www.AMCI.com.
15. Go Online. RSNetWorx will scan the ControlNet network and should discover the NX1F4C.
16. Click on the Enable Edits checkbox and then save the project.

At this point, the 1756-CNB(R) should be communicating; steady green LED and the top right LED (ControlNet Status LED #3) for the NEXUS communication should be on.

Go online to the ControlLogix processor. Select the **Logic** menu, followed by **Monitor Tags**. The data associated with the NX1F4C is available under the name you chose when configuring it.

Quick Start Guide**AMCI Nexus to PLC-5**

1. With the power off, use the rotary switches on the Nexus to select the desired node address.
2. Connect the Nexus to the ControlNet using a ControlNet Tap to coax media. Either the A or B port can be used, depending on how your network is configured.
3. Apply power to the Nexus unit.
4. Start RSNetworkx. If this is the first time using the NX1F4C, register the appropriate EDS file and icon from AMCI's website www.AMCI.com.
5. From RSNetworkx for ControlNet, go Online. After browsing the network, the NX1F4C will appear as an "Extra Device" at the node selected by the Nexus' rotary switches.
6. Click the **Enable Edits** checkbox and choose "Use online data (upload)". Click **OK**. At this point you can right click on the NX1F4C icon and select **Properties** from the pop-up menu. In the properties window, you can change the name associated with the unit and add a description.
7. Go Offline.
8. Click the **Enable Edits** checkbox.
9. Right Click on the PLC-5 icon and click on **Scanlist Configuration** in the pop-up menu.
10. In the Device Name column, right click on the name of the Nexus unit, and click on **Insert Connection** in the pop-up menu. The Connection Properties window will appear on the screen.
11. If needed, set the Input Size and Input Address of the Data Input File. This file resides in the PLC-5 and is used by all of the ControlNet nodes. Therefore, it must be large enough to hold all of the input data on the network. The number of words that the NX1F4C transfers to the PLC-5 is shown below.

32 Input words for the NX1F4C

12. If needed, set the Output Size and Output Address of the Data Output File. This file resides in the PLC-5 and is used by all of the ControlNet Nodes. Therefore, it must be large enough to hold all of the output data on the network. The number of words that the NX1F4C receives from the PLC-5 is shown below.

32 Output words for the NX1F4C

13. Set the Request Packet Interval time. This has a minimum acceptable value of five milliseconds, but can be set higher.
14. Click OK to close the Connection Properties window. In the Scanlist Configuration window, save the changes and close the window.
15. Go Online.
16. Verify that the PLC is in Program Mode.
17. Click on **Network** in the toolbar and select **Download to Network** from the pull down menu that appears. After the download is complete, the Nexus unit should be communicating with the PLC.

NX1F4D (DeviceNet) Hardware Overview

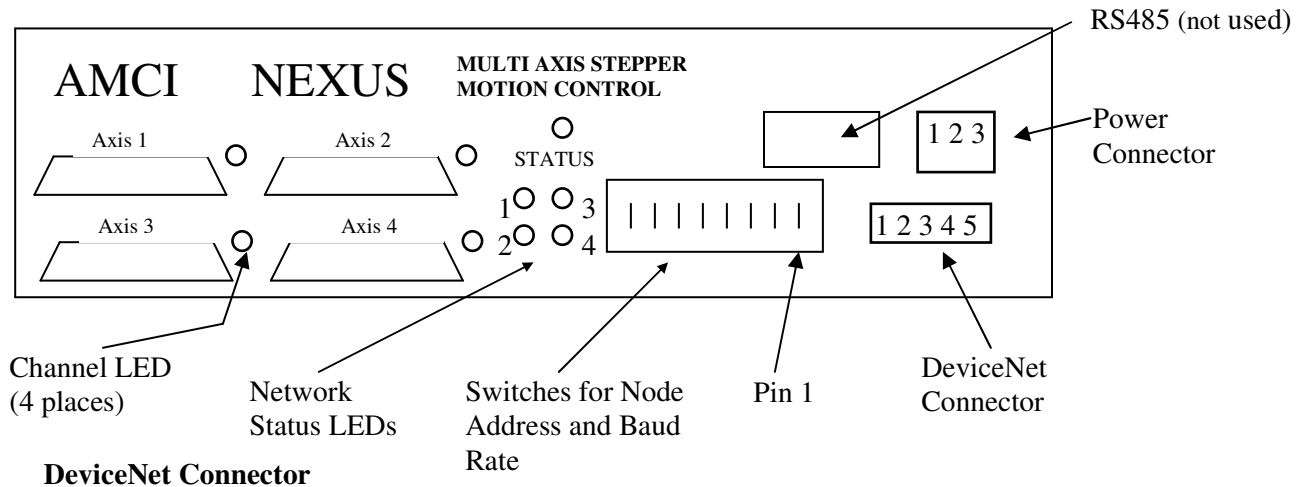

DeviceNet Connector

The 5 pin DeviceNet Connector has the following wiring.

Pin Number	Function	Standard Wire Color
1	+24Vdc (16 mA)	Red
2	Can High	White
3	Shields	Bare
4	Can Low	Blue
5	Common	Black

Node Address and Baud Rate Selection

The NX1F4D uses eight DIP switches to select the Node Address and the Baud Rate. Switches 1 and 2 set the Baud rate and switches 3 to 8 set the node, with switch 8 being the least significant bit. The following table shows the possible switch setting combinations.

The DIP switch package is mounted so that the numbers are upside down. However, “1” or “ON” is still in the up position and “0” or “OFF” is in the down position.

Baud Rate	Switches 1 & 2
125k	0 0
250k	0 1
500k	1 0
Reserved	1 1

Node Address	Switches 3 to 8 3 4 5 6 7 8
0	0 0 0 0 0 0
1	0 0 0 0 0 1
2	0 0 0 0 1 0
61	1 1 1 1 0 1
62	1 1 1 1 1 0
63	1 1 1 1 1 1

Example: For a Baud Rate = 250K and the Node Address = 5, switches 2, 6, and 8 would be ON, up towards the top of the module and switches 1, 3, 4, 5, and 7 would be OFF, down towards the bottom of the module.

Note: The state of the switch settings is only taken into account at power up.

DeviceNet Status LEDs

The following table describes the function of the four network status LEDs.

LED Number	Name	LED Pattern	Description
1	Module Network Status	Steady Off	No Power
		Steady Red	Unrecoverable Fault
		Steady Green	Device Operational
		Flashing Red	Minor Fault
2	Network Status	Steady Off	Not Powered / Not On Line
		Steady Red	Critical link failure
		Steady Green	Link OK, On Line, Connected
		Flashing Red	Connection Time Out
		Flashing Green	On Line not connected
3	Reserved		
4	Reserved		

Network Update Time

The NX1F4D has a minimum network update time of 5ms.

Adding the NX1F4D to your network

Before the NX1F4D can be attached to a network, it must be added to the RSNetWorx for DeviceNet software. The EDS and icon files are available in the *Tech Library* section of our website, www.amci.com. The following procedure to add the EDS file to RSNetWorx assumes that you have already downloaded these files and un-zipped them.

1. With the power off, use the dip switches on the front of the NX1F4D to set the node address and the baud rate.
2. Start RSNetWorx for DeviceNet.
3. In the RSNetWorx program, click on **Tools** in the menu bar.
4. Click on **EDS Wizard...** from the pull down menu that appears.
5. Click on **Next>** in the window that appears.
6. Select **Register an EDS file(s)** and click on **Next>**.
7. Select **Register and EDS file**.
8. Click on **Choose File...** and navigate to the folder where you placed the un-zipped EDS and icon files.
9. Double click on **NX1F4D_r01.eds** file.
10. Click on **Next>**.
11. Click on **NX1F4D_r01.eds** file so that it is highlighted.
12. Click on **Next>** to assign an icon to the device.
13. Click on the NX1F4D and then click on **Change icon...** to select the icon for the Nexus unit. You can choose one of the built in icons from Rockwell Automation or click on the **Browse...** button and select the **NX1F4D_r01.ico** icon file.
14. Click on **Next>** and then click on **Finish** to complete the installation of the AMCI NX1F4D EDS file to the RSNetWorx system.

Once the EDS file is added to your system, add the NX1F4D to your network as you would any other device, including adding it to the scanlist configuration of the scanner module.

NX1F4E (Ethernet IP) Hardware Overview

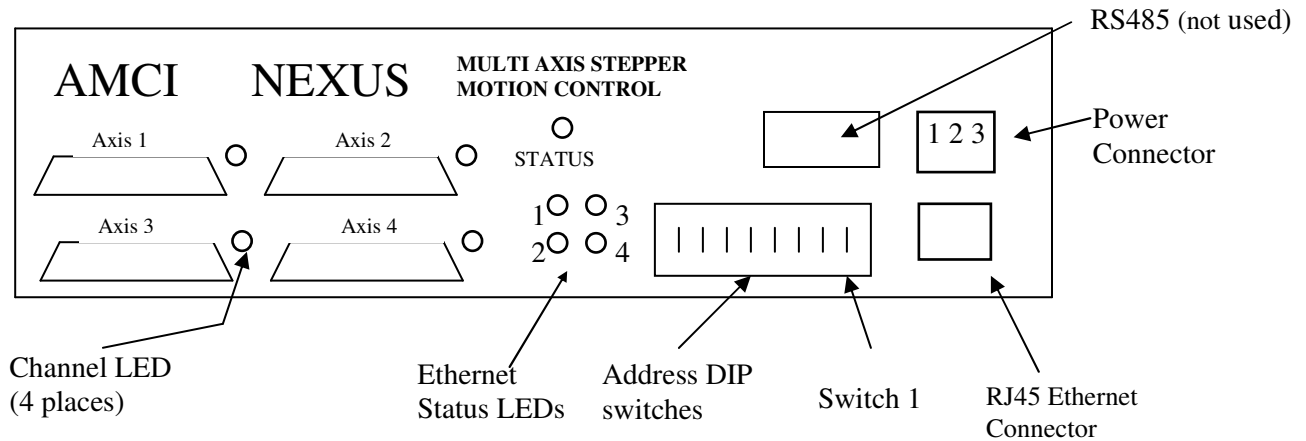

Network Update Time

The NX1F4E has a minimum network update time of 5ms.



See Chapter 8 starting on page 54 for instructions on changing the IP address.

Ethernet Status LEDs

The following table describes the function of the four network status LEDs.

LED Number	Name	LED Pattern	Function
1	Network Status	Steady Off Steady Green Flashing Green Flashing Red Steady Red Flashing Green/Red	The module has no power or no IP address has been assigned. The module has at least one established Ethernet/IP connection. There are no Ethernet/IP connections established to the module One or more of the connections in which this module is the target has timed out The module has detected that its IP address is already in use The module is performing a power on self test
2	Module Status	Steady Off Steady Green Flashing Green Flashing Red Steady Red Flashing Green/Red	No Power. The module is operating correctly. The module has not been initialized. A minor recoverable fault has been detected. A major internal error has been detected. The module is performing a power on self test.
3	Activity LED		This LED flashes green each time a packet is received or transmitted
4	Link		This LED indicates that the module is connected to an Ethernet network

Setup Example

AMCI NX1F4E to Rockwell Automation 1756-ENET/B module

1. With power removed, use the dip switches to set the address of the NX1F4E.
2. Open an existing or create a new ControlLogix program.
3. From the project tree, right click on I/O configuration and select New Module.
4. From the Module Type list that appears, select 1756-ENET/B, the 1756 Ethernet Bridge module.
5. Type a name for the Bridge module, which must begin with a letter, in the Name field.
6. Enter the slot number where the 1756-ENET/B module is located in the ControlLogix rack.
7. In the Address/Host Name field, select the IP Address and enter the address 192.168.000.XXX where XXX can be a unique number between 1 and 254.
8. Click the Finish button.
9. From the project tree, right click on the 1756-ENET/B module and select New Module.
10. Select ETHERNET-MODULE Generic Ethernet Module from the list that appears and click on OK.
11. In the module properties that appear, enter the following parameters.

Name: **Your Choice** (must begin with a letter)

Comm Format: **Data-INT** (must be Data-INT)

IP Address: **192.168.000.XXX** where XXX is the number entered on the DIP switches

	Assembly Instance	Size
Input	100	32
Output	150	32
Configuration	110	0

12. Click on Next.
13. Select the RPI time, minimum = 5ms.
14. Click on Finish.
15. Save and download the program to the ControlLogix rack.
16. While online with the PLC, right click on the Ethernet Bridge module and select Properties.
17. Click on the Port Configuration tab and modify the following fields.

Enable Bootp: **Unselected** (This will allow the data to be manually entered in the IP address and Domain Name fields.)

IP Address: **192.168.000.XXX** (must be the same as step 7 above)

Subnet Mask: **255.255.255.0**

The Gateway Address, Domain Name, Primary DNS Server Address, and Secondary DNS Server Addresses all remain unchanged.

NX1F4P (Profibus) Hardware Overview

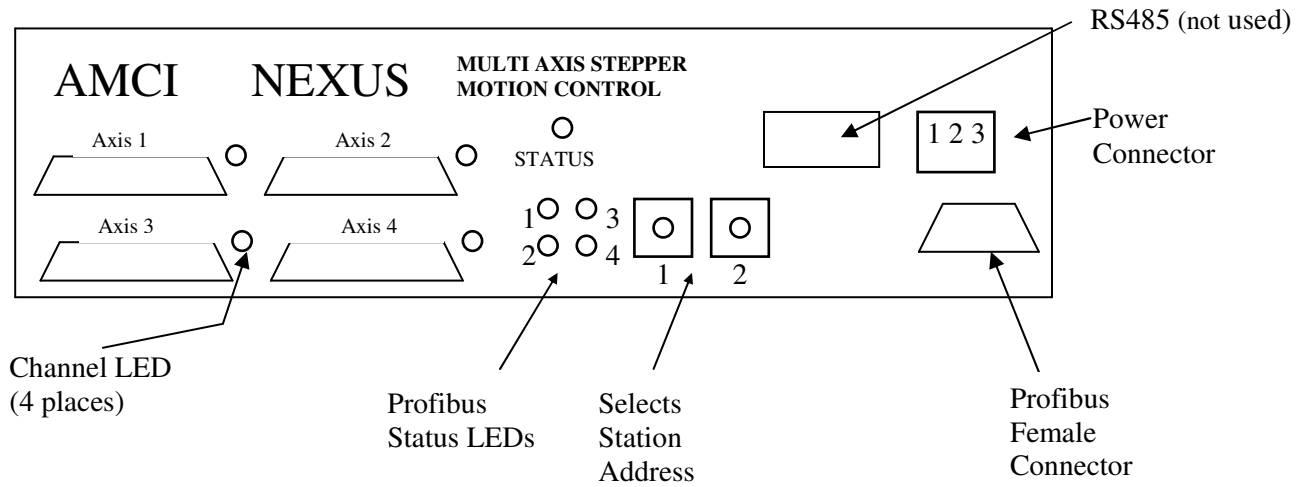

Profibus Status LEDs

LED Number	LED Pattern	Function
1	Red Off	Module is Offline and no data exchange is possible The module is Online
2	Green Off	Module is Online and data exchange is possible The module is Off line
3	Flashing Red 1Hz Flashing Red 2Hz Flashing Red 4Hz Off	Error in configuration: IN and/or OUT length set during initialization of the module is not equal to the length set during the configuration of the network Error in User Parameter data: The length/contents of the user parameter data set during initialization of the module is not equal to the length/contents set during configuration of the network. Error in initialization of the Profibus communication ASIC. No diagnostic present
4	Off	Not Used

Profibus Connector

The Nexus module uses a 9 pin female D-sub connector to communicate with the Profibus network.

Station Address Selection

The Nexus module has two rotary switches used to set the module's address on the network. Any station from 0 to 99 can be selected. Switch 1 sets the one digit and switch 2 sets the 10s digit of the address. For example, if the Nexus is to be installed at station 46, switch 1 would be set to 6, and switch 2 would be set to 4. Note, changing the station address only takes affect at power up. Changing the address while power is applied to the Nexus module will generate a minor fault.

Siemens S7 Installation

1. Select the Universal Module under the Anybus Driver.
2. For the Input Type, select the starting address and sum up the number of available input options until you have reached 32 sixteen bit words (64 bytes).
3. For the Output Type, select the starting address and sum up the number of available output options until you have reached 32 sixteen bit words (64 bytes).

Network Baud Rate

The NX1F4P supports the following network baud rates

9.6 kbits/sec, 19.2 kbits/sec, 93.75 kbits/sec, 187.5 kbits/sec, 500 kbits/sec, 1.5 Mbits/sec, 3 Mbits/sec, 6 Mbits/sec, and 12 Mbits/sec

Quick Start Guide**AMCI Nexus to SST-PFB-SLC Profibus interface module**

1. If it is not already present, install the SST-PFB-SLC module in the SLC rack and configure the rack (the ID code is 13635) for the module.
2. Place the PLC in program mode.
3. Connect a serial cable from the computer's COM port to the RS232 port of the SST-PFB-SLC module.
4. With the power off, use the rotary switches on the Nexus unit to select the desired station address. The left switch sets the 1s digit and the right switch sets the 10s digit of the station address.
5. Attach the Nexus unit to the Profibus network.
6. Apply power to the Nexus unit.
7. Start the SST Profibus Configuration software.
8. Either create a new or open an existing network.
9. If it has not already present, register the Nexus unit's GSD file, **AnyBPRfB.GSD**. This file is available for download from our website, www.AMCI.com.

Click on Library in the toolbar and then select Add GSD file. Choose the directory where the GSD file is located, and then select the file. When registered this module will appear under Slaves as:

HMS Fieldbus Systems AB
ANYBUS-S PDP

10. If SST-PBF-SLC module is not already present, click on Masters. Click and drag the Master (Rev 1.4) into the network. Right click on it and configure it according to your system's requirements.

-
11. Under slaves, click and drag the ANYBUS-S PDP module into the network. The setup window will appear.
 - Under the **General** tab, set the station number to match the station number set by the rotary switches on the Nexus unit.
 - Click on the **Modules** tab and then click on Add. The NX1F4P must be set for 32 input words and 32 output words. If a different number of words is programmed, Network LED 3 will flash indicating an Error in the Configuration. The input words can be located in either the Input Image table or in the M1 file, however, all 32 input words must be located in one file. The 32 output words must be located in the M0 file.
 - Click on Input 64 Byte (32 word) and then on OK.
 - Click on the **SLC Address** tab and then select the Input Type, either I or M1, and the offset value, that is where in the I or M1 table the data begins. It is important not to leave gaps between an existing Profibus module and the data used by the Nexus unit.
 - Again click on the **Modules** tab and click on Add.
 - Click on Output 64 Byte (32 word) and then on OK.
 - Click on the **SLC Address** tab and then select the Output Type to be M0 and then select an offset value. As with the input data, it is important not to leave gaps between an existing Profibus module and the data used by the Nexus unit.
 - Click on OK to accept.
 12. Save the network file.
 13. Right click on the Master Module and select Connect from the menu that appears.
 14. Click on Yes if asked to retain the configuration.
 15. Again right click on the Master Module and then select Load Configuration from the menu that appears.
 16. Place the PLC in Run mode.

NX1F4T (Modbus TCP IP) Hardware Overview

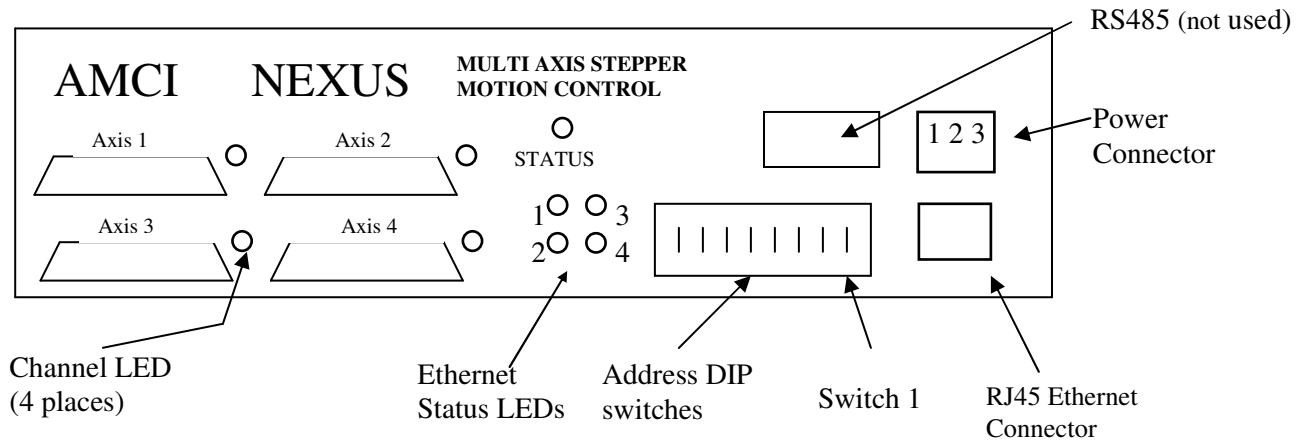

See Chapter 8 starting on page 54 for instructions on changing the IP address.



Modbus TCP/IP Ethernet Status LEDs

LED Number	Name	LED Pattern	Function
1	Network Status	Flashing Green with 2 seconds interval	This LED indicates the number of established Modbus/TCP connections to the module. The number of connections is equal to the number of flashes on this LED.
		Flashing Green/Red	Power-on self test
2	Module Status	Steady Off	No Power
		Steady Green	The module is operating correctly
		Flashing Green	The module has not been initialized
		Flashing Red	Minor recoverable fault
		Steady Red	Major internal error
		Flashing Green/Red	Power-on self test
3	Activity	Flashing Green	This LED flashes green each time a packet is received or transmitted
4	Link	Steady Green	This LED indicates that the module is connected to an Ethernet network

Setup Example

AMCI NX1F4T to Group Schneider's 140 NOE 771 01 module

This setup example assumes that the 140 NOE 771 01 module has already been installed in the PLC system.

1. With power removed, use the dip switches to set the IP address of the NX1F4T.
2. Open an existing or create a new Unity program.
3. Open the Project Browser and click on the  symbol next to Communication.
4. Click on the  symbol next to Networks to show the available networks.
5. If you are creating a new network for the NX1F4T, right click on Networks and select New Network from the window that appears. If you are adding the NX1F4T to an existing network, ignore this step.

Click on the down arrow to the right of the *List of available Networks* field and select *Ethernet* from the drop down menu that appears.

Type the new networks name in the Change Name field

Click on OK to create the new network.

6. Right click on the existing network and select open from the window that appears. The following window will appear.

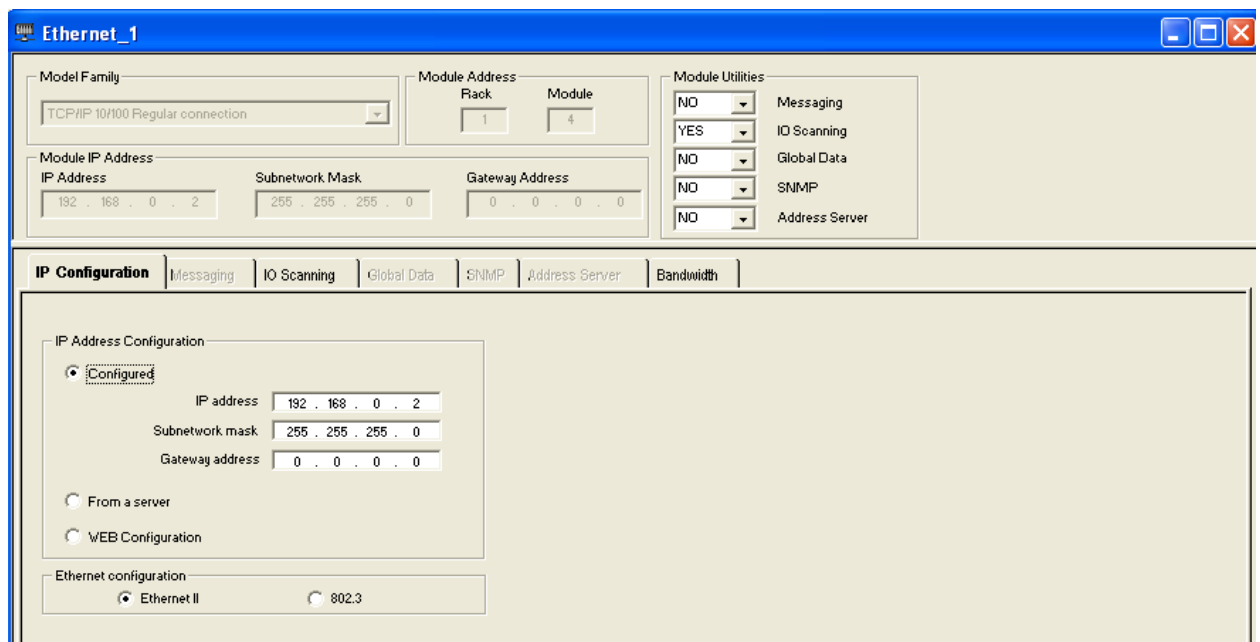

7. Enter the following parameters.



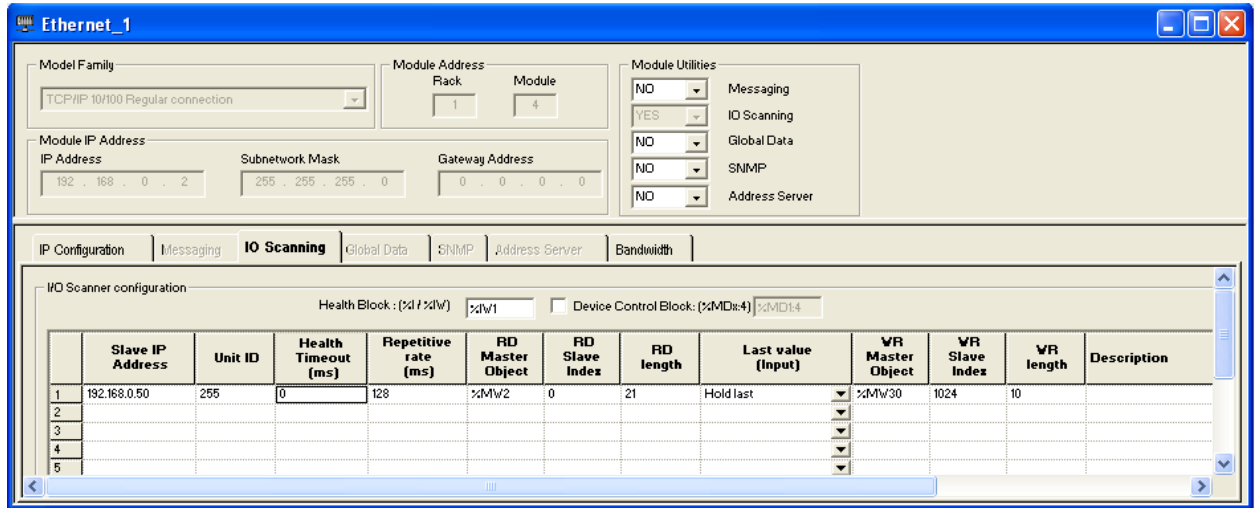

Module Family: TCP/IP 10/100 Regular Connection
 Module Address: Location of the 140 NOE 771 01 module
 IP Address: The TCP/IP address of the 140 NOE 771 01 module
 Subnet Mask: 255.255.255.000

8. Click on the I/O scanning tab. The following screen will appear.



9. Enter the following parameters.

Slave IP Address: IP Address of the NX1F4T module.
 Unit ID: Not necessary for the NX1F4T module. The default value of 255 can remain.
 Health Timeout: Timeout value measured in ms. Can be any value for the NX1F4T module
 Repetitive Rate: Update time of the NX1F4T in ms. A value of zero will result in the fastest transfer of data between the NX1F4T and the NOE module. A value other than zero must be in a multiple of 16.
 RD Master Object: First destination address register where the data transmitted from the NX1F4T will be located.
 RD Slave Index: Must be 0.
 RD Length: Must be set to 32. (The NX1F4T uses 32 16 bit input words)
 Last Value (input): Status of the input registers, either last state or zero, in the event of an error. The data from the NX1F4T will remain in the registers if communications are lost.
 WR Master Object: First source address register location where the data sent from the PLC to the NX1F4T is located.
 WR Slave Index: Must be set to 1024
 WR Length: Must be set to 32 (The NX1F4T uses 32 16 bit output words)
 Description: Your choice of text or leave blank.

10. Close the network.
11. Click on Yes when asked “Do you want to save your modifications?”
12. Click on Yes when asked “Do you Confirm the Modification?”
13. On the Project Tree, expand the I/O configuration by clicking on the  symbol to the left of Configuration.
14. Further expand the I/O configuration by clicking on  symbol to the left of the Local Bus.
15. Continue to expand the I/O configuration by clicking on the  symbol to the left of the Local Quantum Drop.
16. Continue to expand the I/O configuration by clicking on  symbol to the left of the rack that contains the 140 NOE 771 01 module.
17. Expand the networks attached to the NOE module by clicking on the  symbol to the left of the 140 NOE 771 01 module.
18. Right click on the network associated with the 140 NOE 771 01 module and select OPEN from the window that appears.
19. Click on the down arrow on the field just below where it asks you to “Please choose a Network.” Select the network that was created above.
20. Save and build the project, and download it to the PLC. If the NX1F4T is powered up and attached to the network, network LED 3 (the upper right network status LED) should now be flashing and network LED 4 (the lower right network status LED) should now be on solid.

Chapter 8: Setting IP Address of the NX1F4E and NX1F4T

Setting the Ethernet IP Address of an AMCI Nexus unit using AMCI software

1. This software will only work with AMCI Ethernet units that have a serial number of 02110001 or above. A crossover cable will be required to connect units with serial numbers below 07140001 directly, without a switch, to your PC.
2. Download, extract, and run the **AMCI Ethernet Configuration software** from the following page of AMCI’s website.

<https://www.amci.com/industrial-automation-support/software/>

The following window will open.

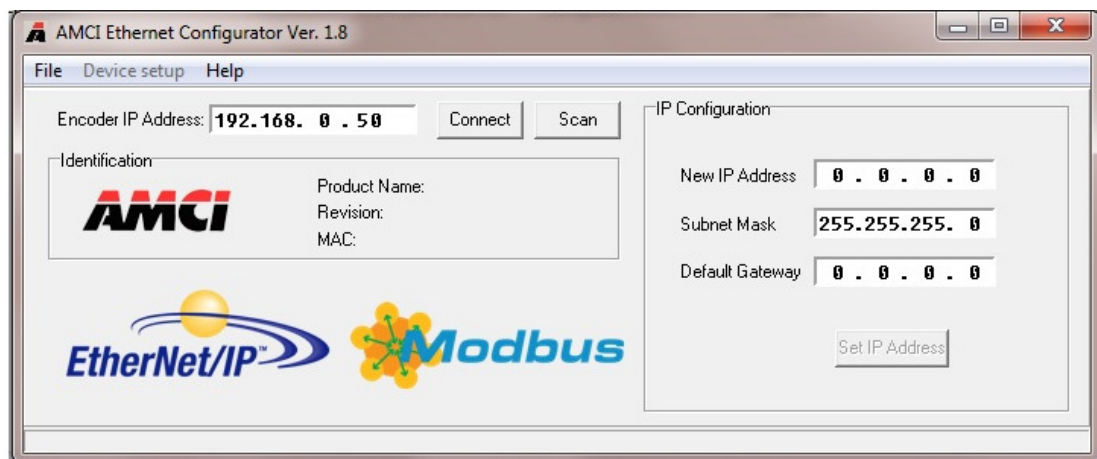

3. The Nexus units ship with a default IP address of 192.168.0.50, where the 50 portion of the address is set by the dip switches. You can use this address, or set all of the dip switches to the ON, up, position if you want to use a previously programmed IP address.
4. Set the Ethernet Port of your PC to be on the same network as the current address IP address of your AMCI Nexus unit. It may be necessary to disable your PC's firewall.
5. Enter the AMCI Ethernet unit's current IP address in the "Encoder IP Address" field.
6. Click on Connect. The button will change from Connect to Disconnect and the lower left hand portion of the window will change from "Idle..." to "Connected to: XXX.XXX.XXX.XXX." The device type and MAC ID will also appear in the Identification field.
7. Enter the new IP address, the subnet mask, and the default gateway in the IP Configuration field. The Default Gateway is required and, unless you have an address that you use for the default gateway, we suggest setting it to the address of the host controller.
8. Click the Set IP Address button. An "IP configuration written successfully" window will be displayed. Click on OK to close this window.
9. Click on Disconnect.
10. Remove power from the Nexus unit. The Nexus unit will not use the new IP address until power has been cycled.
11. **Set all of the switches to the ON (up) position.** This will prevent the Nexus unit for outputting BOOTP requests at power up and lock the new IP address in the Nexus unit's memory.

Using a DHCP/BOOTP Server to change the IP Address of an AMCI Nexus unit

1. Remove power from the Nexus Unit.
2. Set the unit's DIP switches to the OFF (Down) position. This will set the unit's IP address to 0000 0000.
3. Connect your PC to the Ethernet network. A crossover cable will be required to connect units with serial numbers below 07140001 directly, without a switch, to your PC.
4. Start your BOOTP program.
5. Click on **Tools** in toolbar and select **Network Settings**. Verify that the Subnet Mask and the Gateway Address match those of your network. If necessary, change the values to match your network.
6. Click on OK to close the Network Settings window.
7. Click on **New** in the **Relation List**. (Do not click on Enable BOOTP, the Ethernet Nexus units do not support this function.) The Relation List is located in the lower pane of the BOOTP window.
8. Every Ethernet device is assigned its own MAC ID value. This value is located on a label on the side of the Nexus unit. Enter this value in the Ethernet Address (MAC) field.
9. Enter the desired IP address in the IP Address field and click on OK.
10. Apply power to the Nexus unit. The IP Address of a Nexus unit can only be changed at power up.



The Nexus unit sends out several BOOTP requests for the first thirty seconds after power up. It will use the IP address currently stored in its memory if it does not detect a BOOTP server during this time.

-
11. Once power has been restored, the Nexus unit should be listed at the top of the Request History panel with its new IP address.
 12. The IP address has now been changed and will remain at this new value until the next time the Nexus unit detects a BOOTP server at power up that supplies it with a new IP address.
 13. Remove power from the Nexus unit.

If your Nexus unit has a serial number above 0211001, set all of the switches to the up, ON, position. This will lock the programmed IP address in the Nexus unit's memory and prevent the Nexus unit from outputting BOOTP requests at power up.

14. Close the BOOTP server program without clicking on the Disable BOOTP/DHCP program. The AMCI Nexus units do not support the Disable BOOTP/DHCP function. Click on NO when asked if you want to save the changes.

Ethernet Address Selection using the DIP switches

The NX2E4E uses an IP address of 192.168.000.XXX where "XXX" can be any number between 1 and 254. Eight dip switches on the NX1F2E are used to set the "XXX" portion of the address. Switch 8, the left most switch, is the least significant bit and switch 1, the right most switch, is the most significant bit. The address is programmed using the following procedure.

1. Determine the address of the NX1F2E. It can be any unused address between 1 and 254.
2. Convert the address to a binary number. A value of 50 will be 0011 0010.

Enter the address on the dip switches. Continuing the above example, switches 8, 6, 5, 2 and 1 will be off (down) and switches 7, 4, and 3 will be on (up).

Chapter 9: Manual and Firmware revision history

NX1F4X rev 0.0 was released on 8/20/03 and was the initial release of the specifications. This specification combined the previously separate specifications of the NX1F4C, NX1F4D, NX1F4E, and the NX1F4P.

NX1F4X rev 1.0 was released on 6/16/04. The following changes were made.

- The ability to reverse direction of during a blend move was removed from both the firmware and the functionality.
- The Master-Slave mode, the Encoder Follower, and the Registration Move were added to both to the functionality of the unit and to the specifications.
- Additional details were added on the functions of the Move Complete, Command Error, and the Invalid Manual Move bit.
- The name of power connector pin 3 was changed from Shields to Chassis Ground
- The name of pin 12 of the breakout boxes was changed from Chassis Ground to Shields.
- The function of pins 1 and 2 of the DeviceNet network switch settings, which had been reversed on the previous version of the specifications, was corrected.
- The termination switch was removed from the Profibus network diagram.

NX1F4X rev 1.1 was released on 4/28/05. This version added a note to the functionality of ControlNet LED 3.

NX1F4X revision 2.0 was released on 3/23/07. The following changes were made.

- Added General Information and Table of Contents
- Added Output Signals
- Added Single Ended Encoder Wiring
- Added mounting dimensions and drawings
- Added breakout box dimensions
- Ranges and units were added to the output data
- Added the NX1F4T (Modbus TCP IP) to the specifications
- Added changing the IP address to something other than 192.168.000.XXX

NX1F4X revision 2.1 was released on 6/17/2016. The following changes were made.

- The functionality of the NX1F4X-06 new External Input Latch Enable / Clear output bit and the External Input status bit was added to the manual.
- Commands that will reset the move complete status bit were added.
- Details were added to all move commands that will be stopped by an External Input that is configured to stop a Manual Move.
- The encoder move name was changed to encoder registration move. The text describing this move was also changed.
- Added a section of Siemens S7 installation, and a chapter on the various methods of changing the IP address of NX1F4E and NX1F4T units.

Firmware Revisions

Revision 1.4 corrected a problem if the hold/resume commands were issued before the current position data rolled over from its maximum to minimum value or vice versa. This revision also removed the ability to change the direction during a Blend Move.

Revision 2.0 added Master/Slave mode, Encoder Following, and Registration Move to the firmware.

Revision 2.2 added the External Input Latch Enable / Clear function to the unit.

File: NX1F4X_specifications.doc
Date: 6/17/2016